

The background of the cover is a photograph of a rocky coastline. In the foreground, there are numerous tide pools of varying sizes, some containing seaweed. The rocks are dark and jagged, extending into the sea. The sky is filled with large, white, fluffy clouds, with some blue visible between them. The overall scene is a natural, rugged coastal landscape.

edited by

Jason Merchant

Line Mikkelsen

Deniz Rudin

Kelsey Sasaki

A Reasonable Way to Proceed

Essays in honor of Jim McCloskey

A reasonable way to proceed

Essays in honor of Jim McCloskey

Jason Merchant, Line Mikkelsen, Deniz Rudin, and Kelsey Sasaki (eds.)

Santa Cruz—Berkeley—Chicago

March 2018

Typesetting by Kelsey Kraus
Illustration by Kim Bennett
Cover design by Nicholas Merchant
Cover photo by Catherine Cronin

This book is an open access publication made possible by the University of California's eScholarship Repository. Its contents are the intellectual property of the authors, licensed under a Creative Commons Attribution-ShareAlike 4.0 International License.

Table of Contents

Dedication	1
Foreword	3
On the exponence of gender in the Irish DP Paolo Acquaviva	7
The derivation of verb initiality in Santiago Laxopa Zapotec Jeff Adler, Steven Foley, Jed Pizarro-Guevara, Kelsey Sasaki & Maziar Toosarvandani	31
An Old Irish story of a women poet in Donegal Liam Breatnach	51
Maximize Presupposition and types of indefinites in Chamorro Sandra Chung	59
Irish questions are relative Cathal Doherty	87
On the interaction of head movement and ellipsis in Danish Vera Griбанова & Line Mikkelsen	105
A definiteness effect with theme passives in West Flemish? Liliane Haegeman	125
Ellipsis as a test for Constituency Jorge Hankamer	149
Matching light elements Junko Ito & Armin Mester	169
Passivization of German double-object constructions: Theory and usage Vera Lee-Schoenfeld	193
We say “How high?”: Adverbs, negation, and verb movement in a verb-final language Emily Manetta	211
Verb-stranding predicate ellipsis in Greek, implicit arguments, and ellipsis-internal focus Jason Merchant	229

TÍOLACADH

*Ní saoi gach file lé fios;
nocha n-ughdar gach éigios;
do chneasa ad-chiam gan ainimh;
dá dtrian feasa fiafraighidh*
-Muireadhach Ó Dálaigh (1213)

Ar na suáilcí líonmhara go bhféadfai a áireamh agus cur síos á dhéanamh ar an Ollamh James McCloskey (Jim) fiosracht dhocheansaithe chun fionnachtana a bheadh ar bharr an liosta, dar liom. Ón uair gur chuir mé aithne air corradh maith agus daichead bliain ó shin, rith sé liom gur duine é Jim a raibh cíocras chun foghlamtha air, gur tógáil croí dó theacht go húr ar smaoineamh nua, ar cheol nár chuala sé roimhe, ar dhearcadh eile fealsúnachta, ar dhioscúrsa difriúil meabhraitheach faoi chúrsaí an tsaoil sa bhaile agus i gcéin. Níl aon mhaolú ar an fhiafraitheacht sin ná ní lú a lúcháir inniu féin agus cur chuige úrnua i leith na n-ealaíon agus na n-eolaíocht sin á aimsiú aige. Bua eile dá chuid nár lagaigh le himeacht ama a fhéile is a bhí sé agus atá sé agus é ag roinnt na léargas sin s'aige ar chairde agus ar chomhleacaithe ar aon. Ar a bhealach séimh cineálta féin, is béas aige údarás agus cneastacht. In ainneoin bhearna ama agus achair, níor chaill sé ariamh a dháimh lena bhunadh i nDoire agus treisíodh ar a dhomhain-thuiscint agus a shaineolas ar Ghaeilge na Rosann. Duine ar leith, eagna ar leith, cara ar leith; gura fada buan é.

Cathal Goan

FOREWORD

Jim McCloskey's contributions to our field—theoretical syntax in particular—are myriad. He has made major advances in our understanding of resumption, ellipsis, existentials, clefts, subjecthood, relative clauses, verb-initiality, and the syntax-prosody interface, to name only a few. Though his work has been predominantly syntactic, it has consistently displayed an uncommonly sophisticated engagement with semantics and with phonology.

The above alone would comprise a noteworthy career for any theoretician. This makes Jim's career all the more remarkable, because the above is only half of the picture. Jim's work has not only grappled deeply and productively with theoretical issues of relevance to linguistic theory writ large, it has done so through an equally deep attention to the fine-grained messiness of the empirical terrain, and a sensitivity to dialectal variation at an almost microscopic level. The theory is put to work to help make sense of complicated data, and that data is used to illuminate the larger theory. Jim's lifelong engagement with Irish and Irish English has provided a model for how to combine rigorous theoretical work with careful, community-involved fieldwork, a pairing that has come to be emblematic of the Santa Cruz style of syntax. His commitment to working on and in the Irish language reaches beyond theoretical linguistics, into the vitally important realms of language documentation, revitalization, and advocacy. In this respect as well, Jim has been an inspiration to several generations of Santa Cruz linguists.

In essentially all of Jim's work, there is a masterful balance between the global view and the (hyper)local. This skill is one of the marks of an expert storyteller. Indeed, Jim's characteristic habits of thought, as reflected in his writing, his teaching, and even his comments on advisees' drafts, are narrative. He is attentive to the story of how the field arrived at its current state of understanding, and to how his contributions advance that narrative, always trying to push our understanding forward rather than trying to have the final say. The title of this volume, a favorite Jim-ism of ours, is a perfect encapsulation of this narrative temperament. This quality is reflected in Jim's engaging and adventurous papers and lectures—always enlivened by Jim's friendly-yet-incisive brand of humor—which have an uncanny ability to "catch the mind off guard and blow it open."

As an advisor, Jim encourages these qualities—among many other healthy intellectual habits—in his characteristically nurturing manner. He takes special care to make it clear to his advisees that he has faith in them, and is a remarkably energetic advocate for his students' work. It is not uncommon for Jim's students to see their qualifying paper manuscripts cited in his presentations, nor for them to hear him reference their work in the Q&A periods of talks given by eminent linguists. That so many of Jim's students have found sustained success in academia is a sign that Jim's steady faith has been well-placed, and his patient coaching highly effective.

On a personal level, Jim is unfailingly affable, warm, and actively engaged in making our community at Santa Cruz such a pleasant place—a community in the truest sense, linked by camaraderie and affection, not just professional courtesy. He is a widely beloved figure in a field that, as Jim famously pointed out, sometimes seems to “thrive on a . . . diet of anger, polemic, and personal abuse.” Jim’s presence in the field has long been a welcome counterweight to this tendency.

When we began organizing this festschrift, it was intended to commemorate the 30th anniversary of Jim joining the faculty at Santa Cruz. While we were in the process of putting it together, Jim announced that his 30th year would be his last, so we’ll take the opportunity to celebrate his retirement as well. We look forward to many more years of enjoying his beneficence and the light of his brilliantly insightful mind.

Jason Merchant
Line Mikkelsen
Deniz Rudin
Kelsey Sasaki



On the exponence of gender in the Irish DP*

Paolo Acquaviva
University College Dublin

1 INTRODUCTION AND PRELIMINARIES

1.1 GOALS

For a language with two gender values, Irish has a surprising amount of morphological variation and instability, which emerges when looking closely at the dialects which collectively make up the language. We owe to Ó Siadhail (1984) an early formulation of the problem, which identified the key aspects of this irregularity: some nouns vary in gender value across dialects, some have alternative values in the same dialect, some display genitive endings that are characteristic of one gender value but trigger a mutation on following adjectives that expresses the other value, and some have different values (evidenced by the form of the article) in the nominative and in the genitive. In addition, the choice of the gender value for pronouns anaphoric to a DP is often not dictated by morphological agreement with the antecedent but determined on semantic grounds. The following sections will illustrate these categories with several examples; however, since more recent research has considerably sharpened the picture, my main goal will not be to describe the phenomenon. I will rather address the question of what these data can tell us about the competence underlying such puzzling behaviour. A truly satisfactory theory would model the Irish competence in such a way as to predict the boundaries of non-deterministic variation: where gender may fail to determine a certain spell-out, where it may not, and above all, why this is so. As a contribution towards that goal, this paper aims to show that the instability in the exponence of gender in the Irish DP coexists with a significant core of systematicity. This can only be appreciated if we draw a clear distinction between the two types of exponence in question, namely initial mutation (mainly lenition) and phonologically overt exponents. The latter, namely articles and nominalizing suffixes, act as overt exponents which directly spell out a gender value. Initial mutation, on the other hand, is a piece of the Irish morphological system (a morpheme, in the sense introduced by Aronoff 1994; see Luís and Bermúdez-Otero 2016) which has several functions, only one of which

*The work of James McCloskey has been an inspiration for many people, and I am one of them. I would like to express my thanks to him for all he has done and for what he has meant for so many.

is the marking of a configuration of gender agreement inside DP. Its realization is subject to a number of constraints, particularly complex in the case of the complement of a lexical noun. It is this relation between mutation and gender agreement that is subject to a significant weakening; when gender has a different realization, its systematic morphological realizations are stable. An empirically successful theory must account for this state of affairs.

1.2 IRISH - HOW MANY SYSTEMS?

Not many grammatical properties can be attributed to Irish as a unitary system of native linguistic competence, and gender marking is not one of them. It is true that all modern varieties oppose two gender values, through a system of morphological oppositions which is clearest in pronouns. It is also true that the exponents for articles and nouns/adjectives are uniformly the same, namely lenition and choice of a special feminine form for some lexical items (including the article); and that the bulk of nouns continues to have the gender value it had in previous historical phases, making allowance for the disappearance of the neuter (predictably, old neuters figure frequently in the list of nouns whose gender value does not align with that of other varieties). Still, we cannot analyze the morphology of gender in Irish as if it was a subpart of a single linguistic system. Irish is a set of native dialects surrounded by a much greater number of speakers with varying standards of fluency, most of whom look to the official standard as a reference point. When we approach Irish as an I-language, the store of tacit knowledge which constitutes native competence, the problems come into focus. If descriptions are sufficiently detailed, they display a significant amount of nouns whose gender value varies; it is not rare to find nouns which must be described as having both gender values. The same unusual variability often characterizes the initial lenition which feminine nouns would normally trigger on a following adjective. Particularly significant are cases where usage is explicitly said to be inconsistent: to consider a single example, Ó hUiginn (1994: 563) reports that in Connacht Irish *cleachtadh* 'habit, practice' is shown to be masculine by the lack of lenition after the definite article (*an cleachtadh*) but as feminine by the lenition it triggers on the onset of a following adjective like 'good' (*cleachtadh mhaith*) (also noted in Ó Siadhail 1984: 174). A model of the native competence of individuals and speech communities, then, cannot just deterministically link gender value and certain patterns of exponence, without also making room for this sort of variability.

For this reason, our empirical focus will be not on how gender is expressed in any one variety, but how much in this exponence can *fail* to be expressed, or the extent to which non-deterministic choices are tolerated. Our goal is to obtain a sharper picture of the extent of this grey area — in particular, to determine its boundaries.

1.3 GRAMMATICAL AND SEMANTIC GENDER

Discussion of gender in Irish is typically bound up with the issue of “semantic” gender assignment in pronominal anaphora: while a pronoun referring to a preceding DP generally takes the same gender value, this can be overridden. In (1), the DP *cailín deas* is grammatically masculine (as shown by the lack of initial lenition on the adjective *deas*),¹ but it is resumed by a feminine pronoun *í*; and in (2), the noun *ainm* ‘name’ is preceded by the feminine variant of the article *an*, which does not insert a *-t-* in front of the initial vowel, yet the pronoun resuming it is the masculine *é* (both examples from Ó Sé 2000: 87):²

- (1) *Cailín deas is ea í*
girl nice COP PRED 3SG.F
 She is a nice girl.
- (2) *Is é an ainm a bhí uirthi ná Móire*
COP 3SG.M the name PRT be.PST on.3SG.F PRT Móire
 Her name was Móire.

This phenomenon is undoubtedly significant, but it concerns the choice of a gender value in anaphora, as opposed to its realization in DP. Like the well-known parallel phenomena in languages like German (*das* [neuter] *Mädchen* ... *sie* [fem.], ‘the girl ... she’), it shows that a value arising from the interpretation of DP can override the value determined (syntax-internally) by agreement between D and N, when it comes to determining the gender value imposed by a DP to a referentially dependent pronoun. However, this does not mean that the gender of D is chosen on the basis of meaning, rather than on the basis of grammatical agreement with N. It is the value of DP as a whole, as agreement controller, which in such cases is determined semantically; but D itself is regularly realized according to the value determined by N: *das Mädchen*, never **die* [fem] *Mädchen*. This is not a particularly insightful or novel observation, but it should be remembered in order to avoid taking facts like (1)-(2) as evidence that grammatical gender is superseded by semantic gender. As the in-depth discussion of Lindau (2016) makes clear, it is better to think that the featural makeup on D in such cases has the full complement of values, those determined by morphological agreement (“concord”) and those determined by semantics (“index”; Lindau 2016: 978 usefully explains it as ‘the grammaticalized content of the semantic denotation of the noun’). Since cases like (1)-(2) are quite frequently reported for all varieties of Irish, the conclusion to draw is that pronominal anaphora often disregards the morphological marking on D but this marking is still there.

It bears stressing that the pattern shown in (1)-(2) is not evidence that a gender value is attributed on the basis of “natural” gender, as if it was an objective categorization opposed to a language-internal one. This is because nouns for inani-

¹*Cailín* is grammatically regularly masculine, despite its meaning, because it is formed with *-ín*, which is here a noun-forming suffix and not a noun-modifying diminutive one; see 4.1 below).

² I use the following abbreviations: COP = copula, F = feminine, GEN = genitive, M = masculine, POSS = possessive, PRT = particle, PST = Past.

mates too can enforce or favour feminine agreement with pronominal anaphora, as (2) shows with the noun *ainm*. The personalization of inanimate nouns like *bád* ‘boat’, *carr* ‘car’, *geansaí* ‘jersey’, and even of recent borrowings like *rólar* ‘roller’, all referred to by feminine pronouns, was one of the subcategories identified by Ó Siadhail (1984: 176) for inanimate nouns, alongside non-personalized cases like *áit* ‘place’ and *uair* ‘hour’ which are resumed by masculine pronouns despite being grammatical feminine. But there is nothing “natural” in associating feminine with certain inanimate referents: semantics does play a role in gender assignment, but it is not extra-linguistic properties of the referents that determine a value.

Having clarified the role of the semantic motivation of gender value in pronominal anaphora, I will now focus on the grammatical, language-internal aspects of this category; in particular, on the determination and expression of gender value inside DP.

2 THE EMPIRICAL PROBLEM

2.1 GENDER MORPHOLOGY IN DP: THE NEAT PICTURE

Outside of the pronominal system, the masculine-feminine opposition has a morphological realization in the singular of the definite article (Irish has no indefinite article, and there is no gender opposition in the plural), and in the shape of attributive adjectives agreeing with the noun. Articles define the paradigm shown and exemplified in (3):

(3) definite article

	Nominative/accusative case	Genitive case
masculine	<i>an</i> <i>an t-</i> before vowels	<i>an</i> + lenition of following consonant (when applicable) <i>an t-</i> before initial <i>s-</i>
feminine	<i>an</i> + lenition of following consonant (when applicable) <i>an t-</i> before <i>s</i> + vowel or sonorant	<i>na</i> <i>na h-</i> before a vowel

	Nominative/accusative case	Genitive case
masculine	<i>an bata</i> ‘the stick’	<i>an bhata</i> ‘of the stick’
	<i>an t-athair</i> ‘the father’	<i>an athar</i> ‘of the father’
	<i>an saol</i> ‘the life’	<i>an tsaoil</i> ‘of the life’
feminine	<i>an chiaróg</i> ‘the beetle’	<i>na ciaróge</i> ‘of the beetle’
	<i>an tseiod</i> ‘the jewel’	<i>na seiode</i> ‘of the jewel’
	<i>an aimsir</i> ‘the weather’	<i>na haimsire</i> ‘of the weather’

The contextual changes triggered by the articles interact with the inflectional variability of lexical stems, so that for example *seoid* becomes *seoide* in the genitive. Adjectives have their own inflectional behaviour: some are invariable, others change in form depending on number, and some depending on gender too. A more general, and for us more relevant, exponent of gender for adjectives is the lenition of the initial consonant, which accompanies feminine singular attributive adjectives. Given the order article – noun – adjective, the lenition on the adjective can be seen both as a marker of DP-internal feminine agreement, and as an effect of the linearly preceding noun. Some illustrations are provided in (4):

(4) *Masculine noun + adjective*

- a. *an fear mór an fhir mhóir* the big man of the big man
- b. *an fear maith an fhir mhaith* the good man of the good man
- c. *an scéal cáiliúil an scéal chailiúil* the famous story of the famous story

Feminine noun + adjective

- a. *an tseoid bheag na seoide bhige* the small jewel of the small jewel
- b. *an bhean cháiliúil na mná cailiúla* the famous woman of the famous woman
- c. *an aimsir Éireannach na haimsire Éireannaí* the Irish weather of the Irish weather

2.2 GENDER MORPHOLOGY IN DP: THE MESSY PICTURE

The phenomena that make the morphology of gender in Irish DPs less than systematic can be summarized under the following three headings:

- oscillations in gender value for nouns
- oscillations in gender value for a given noun, according to case

- misalignment of the exponents of feminine gender (lenition and realized morphology)

The first heading does not refer to cases where an opposition in gender expresses two semantically distinct readings, distinguishing what can be legitimately viewed as two homonymous, inflectionally identical nouns (like *mám*, masculine as mountain pass, feminine as handful, or *ráth*, masculine as earthen rampart, feminine as shoal of fish; Ó Curnáin 2007: 506 identifies such a semantic split between the masculine and the feminine use of *méid*, respectively as amount and size). The oscillation consists instead in nouns that have the same meaning but can occur with either gender value. This sort of anomaly is prominent enough to have been recorded even in descriptions of the (artificially codified) standard. The official standard originally issued in 1958 (*an Caighdeán Oifigiúil*, CO), followed by the official 1978 dictionary by Ó Dónaill, mentions distinct genitive forms of the masculine *talamh* earth, namely the masculine *talaimh* and the feminine *talún*. What is an isolated exception in the standard, however, takes different proportions in the dialects, which alone reflect native states of linguistic competence. Ó Siadhail (1989: 147) lists the following examples of nouns that are masculine in some dialects but feminine in others:

	NOUN	DIALECTS, N IS MASC	DIALECTS, N IS FEM
	<i>ainm</i> ‘name’	Donegal, Connacht	Munster
(5)	<i>asal</i> ‘donkey’	Donegal	Connacht, Munster
	<i>condae</i> ‘county’	Connacht, Kerry	Muskerry, Donegal
	<i>mí</i> ‘month’	Munster	Donegal, Connacht
	<i>páighe</i> ‘pay’	Munster	Donegal, Connacht

Some other cases involve very minor changes in form:

	<i>gaineamh</i> sand	Connacht, Teelin	Erris, Munster (<i>gainimh</i>)
(6)	<i>paráiste</i> parish	Connacht, Kerry	Muskerry (<i>paróiste</i>), Donegal
	<i>tubaiste</i> ‘disaster’	Donegal, Connacht	Munster (<i>tubaist</i>)

More specific descriptions reveal more cases where the gender value in one dialect contrasts with the value of others, or the standard (typically in the sense of all other varieties). In his overview of Munster varieties, Ua Suilleabháin (1994) discusses among other discrepancies the feminine *ainm* noun, name, *dlí* law, *guth* voice, *srian* bridle. For Ulster, Hughes (1994: 629) reports that *tír* land, country is usually feminine but fails to lenite the following adjective in the fixed phrase *tír mór* mainland.

More interesting are the cases where *both* gender values are reported as current, in the same dialectal area: Ua Súilleabháin mentions *iúna* wonder, *brí* strength (fem. in Corca Dhuibhne, masc. or fem. in Muskerry), and the series of loanwords *tae* tea, *siúcra* sugar, and *béile* meal; in addition, he mentions *loch* lake, which Ó Siadhail (1989: 147) calls a particularly good example, where the genitive singular fluctuates from dialect to dialect between the feminine *na locha*, *na loiche*

and the masculine *an locha* with no discernible pattern. As for the Connacht dialect, the classic description of the variety of Cois Fharráige by de Bhaldráithe (1977) states on its very first page that a few nouns have two genders, listing the following examples: *aistir* journey, *cleachtadh* habit, practice, *deatach* smoke, *éisteacht* 'hearing', *eolas* knowledge, *fad* length, *leabhar* book, *méid* amount, size, *oiread* amount, *talamh* earth. The overview of Connacht dialects by Ó hUiginn (1994: 562) also discusses *am* time, and adds the observation like some of these words, they take the masculine form of the article, but often the feminine form of the adjective after them, for example *an cleachtadh* but *cleachtadh mhaith*, *an t-eolas* but *eolas mhaith* [translation PA]. Ó Siadhail (1984: 174) noticed that this irregular feminine pattern of lenition triggered by a usually masculine noun takes place in the absence of an article:

It is significant that in all the examples I have found of a lenited adjective following an otherwise masculine noun the noun is always indefinite. I have come across no examples such as **an aistir mhaith*, **an eolas maith*.

As we will see directly, however, even this subregularity proves less than absolute when the analysis is more detailed. The more recent and vastly more detailed (four volumes) single-dialect description by Ó Curnáin (2007) features far longer lists, with five pages devoted to nouns that are feminine and three pages for nouns that are masculine in the Connacht dialect described, but have the opposite value elsewhere or in closely related dialects (vol. I, 497-502, 503-505). In several of the nouns listed, masculine or feminine are in fact both recorded.

The next two headings are more important. Ó Curnáin (2007) explicitly discusses the pattern of gender dependent on case (p. 505), where a noun has the morphology of one value in the nominative/accusative case but that of the opposite value in the genitive. For instance, *leabhar* book is regularly masculine in the genitive, but which can be masculine or also feminine in the nominative/accusative (the example produced is an *leabhar dhubh sin* that black book. Ó Curnáin also mentions *talamh* earth, *trinse* trench, and especially in fixed collocations *am* time, *scéal* story, and *Gleann* valley, the last in a placename). Even more striking is the simultaneous presence of masculine and feminine morphology side by side. Such is the case of *cleachtadh*, which takes the masculine article, i.e. *an cleachtadh*, but like a feminine noun, lenites a following adjective. This is very common in the phrase without the article *cleachtadh mhaith* (Ó Curnáin 2007: 506). The same happens with *iomaire* ridge, in the phrase *an t-iomaire mhór* the big ridge (Ó Curnáin 2007: 504; masculine article, feminine lenition on the adjective *mór*; this represents a counterexample to the generalization tentatively put forward in Ó Siadhail 1984).

What matters, then, is not so much that a few or many words vary in gender assignment across the dialects (in itself, a natural state of affairs), but that the exponence of gender value is often irregular and sometimes inconsistent, to the point of making it problematic whether a noun really has a unique gender value

in a single, quite homogeneous dialectal variety, or indeed in individual competences. Ó Curnáin (2007: 500-501) is explicit on this point when noting, for instance, that in query both *sábh maith* and *sábh mhaith* were offered [good saw, masculine and feminine respectivelyPA], or that a speaker is hesitant between *an iascach* and *an t-iascach* [fishing, fishery] and actually self-corrects. This last example should be related to the masculine *an t-* in the phrase *an t-iomaire mhór*, mentioned a few lines above. Together, they show that the instability does not concern just the juncture between noun and adjective, but also that between article and noun. It is interesting that most cases of exceptional, irregular feminine lenition by a noun are attested when the noun is not preceded by an article, as noted by Ó Siadhail; but this is only a tendency and does not seem to be mandated by some grammatical principle.

2.3 OLDER AND YOUNGER SPEAKERS

The corpus study of Frenda (2011) adds another dimension to these interim conclusions. It contrasts the marking of feminine gender in two corpora, one older, linguistically conservative (it is a selection from the 1964 study edited by Wigger 2000), and one contemporary, taken from Raidió na Gaeltachta (Irish-language state broadcasting station) and other media sources between 1997 and 2007. One important result that emerges from this comparison study is first of all the sharp increase in semantically-based pronominal anaphora, where a pronoun resumes a DP using the gender motivated by the corresponding discourse referent and not by the grammatical gender of DP. This datum, however significant in itself, does not impinge on the status of gender morphology inside DP.

More relevant here is that the contemporary corpus evidences a decrease in feminine agreement between article and noun, with 88% of the cases (136 out of 155). By contrast, the percentages of correct article agreement in the older corpus were 98% for masculine and 97% for feminine, and more significantly, also the contemporary corpus showed correct masculine agreement in 97% of the cases.³ By agreement is meant the congruence between form of the article and assumed gender of the noun; this does not distinguish between initial mutation (lenition, t-prefixation) and shape of the article itself (*an* or *na*).

The sharpest mismatch between the two corpora concerns gender agreement on attributive adjectives. Frenda notes that these are infrequent in both, and in practice display agreement (feminine) only by means of initial lenition, since only eleven tokens in both corpora displayed agreement by a distinct stem form (six and five for the older and the contemporary respectively). After again disaggregating a few proper names, the difference between the two corpora is stark: adjectives agree in feminine gender (i.e. are lenited) with a feminine noun controller 28 times out of 31 in the older corpus, or in 90% of cases, but only 8 times out of 19 in the contemporary one, or in 42% of the cases. Incidentally, even masculine agreement, which in this case is simply lack of any marking, is not 100% in either corpus: 47 out of 50 times and 49 out of 54 times).

³Proper names were disaggregated and shown to be not statistically significant.

Some caution is needed before drawing conclusions from FrenDas figures, of course, and not only because the relevant potential agreement targets are a small number (the results are statistically relevant within the corpus, but we cannot a priori know how representative the sample is of the spoken Irish of the relevant generations). Firstly, in the light of the variation in gender assignment for nouns shown by Ó Curnáin (2007) (occasionally even with the same speaker), some instances of wrong agreement might simply go back to a non-standard gender assignment. Secondly, the data conflate together initial mutation and choice of article form, but the two types of exponents might be partly decoupled (I will develop this suggestion later on). The lack of lenition on adjective or noun is taken as correct masculine agreement, in the appropriate context; but it could as well signal the lack of any morphological marking, as FrenDa acknowledges in response to a referee (he also adds, correctly, that the gender opposition would still be morphologically active, in view of the other cases). This observation generalizes: in many cases gender may simply fail to be expressed, something which Ó Curnáin (2007: 497) also draws attention to by pointing out that cases of nonlenition are often ambiguous as to gender, particularly when there is a possibility of homorganic nonlenition.

Still, two important results remain: first, lenition of an attributive adjective after a feminine noun seems decidedly recessive; second, this contrasts with the realization of agreement between noun and article (in both forms it takes, lenition noun and form na of the article), which also fails sometimes but generally holds its ground.

The tendency towards nonlenition of attributive adjectives after feminine nouns contrasts with the situation reported by Ó Curnáin (2007: 1736) for a homogeneous local variety: Feminine singular nouns, not inflected for genitive case, regularly lenite attributive adjectives, less regularly nouns. We should also note that a case like *an t-iomaire mhór*, with masculine *an-t* and feminine *mhór*, goes against the tendency reported by FrenDa (2011): either the noun is masculine, and then the lenited adjective is an overapplication of feminine lenition; or it is feminine, and then what is deviant here is the agreement with the article.

However, the contrast might not be as sharp as it seems. Ó Curnáin takes into account the fact that several nouns have a non-standard masculine gender value; his hinting that nonlenition could say nothing about gender is important, because FrenDas data might follow from lenition being generally less regular in general, more than from gender not being grammatically represented. Ó Curnáin (2007: 506) clearly identifies a reduction of feminine gender marking in nominals as a feature of younger speakers (born after 1960). Interestingly, however, he calls this gender depletion: it is not as if masculine and feminine were grammatically equivalent choices, and one is encroaching on the other, but rather that gender marking usually means feminine marking, and this surfaces less and less frequently.

I will develop this line of interpretation, but with an important twist motivated by FrenDas data. The fact that lenition between articles and nouns survives better than that between nouns and adjectives, *in proportion* (so, making

allowance for the fact that the second configuration is much less common), is not easily compatible with the idea that what is disappearing is the feminine gender. Because if it were so, we would expect to see a generalized rise of masculine morphology, with many more cases of wrong masculine article in front of feminine nouns, like *an t-iarnáil* the [masc] iron cited by Ó Curnáin (*ibid.*) for a speaker who otherwise follows the older practice of treating as feminine loanwords in *-áil*, like *an ghesáil* the [fem] guessing.

3 A PUZZLE

The preceding section should have made clear that gender is undoubtedly still a morphological category of Irish nominals, but its exponence has oscillations and inconsistencies which are definitely not usual for an inflectional category. In particular, the fact that the morphological reflexes of feminine gender are much better preserved on articles than between nouns and adjectives, speaks against a simple interpretation of this situation as a system in flux. Stated in these terms, the situation may be unclear, but not particularly puzzling. However, two facts make it harder to make sense of it.

3.1 NO GENDER INSTABILITY WITH DERIVATIONAL SUFFIXES

The first is that some nominalizing suffixes determine a grammatical gender value for the DP in a way that does not admit overriding, no matter how unstable gender morphology might be (cf. already Ó Siadhail 1984). Of course, many nouns that are not (or no longer synchronically analyzed as) suffixed also have just one fixed gender value across all dialects. But when a value is associated to a suffix, rather than a lexical noun, it is a grammatical fact about the morphology of the language as a system, not a separate piece of knowledge for each word the suffix appears in. Establishing exactly which suffixes do and don't allow gender variation would obviously be a major undertaking, across all dialects. But some candidates can be advanced with confidence: the agentive *-eir*, *-eara*, *-óir* (*-tóir*, *-teoir*, *-adóir*), *-i*, *-ire* would seem to be consistently masculine; the individualizing *-án* seems also regularly masculine, while *-óg* is its feminine counterpart (see Ó Siadhail 1984: 173 for a similar list). Ó Curnáin's (2007: 497-501, 503-505) five-page and three-page lists of irregularly feminine and masculine nouns notably lack items with those suffixes, in contrast to other suffixes (like those deriving abstract nouns in *ú*, *-acht*, *-as*) which admit either gender value. Cases like *al-tóir* altar, *buái* buoy, and *ráipéar* rapier are clear loanwords, where the ending is arguably not a separate suffix in the structure of the word. The one exception is *scológ* freeholder farmer (p. 505), which however is attested as masculine only in the compound versions *seanscológ* and *scoloigín*. In sum, although stating that certain suffixes never admit alternative gender values is very easy to disprove, I will claim that at least some suffixes indeed have this property. The feminine *-ó* is probably the safest, and the clearest illustration. It used to be a diminutive,

as shown by pairs like both hut - *bothóg* shanty, cabin (beside *bothán*), but it is no longer productive in that capacity (Doyle 1992: 122-130). Its function is that of deriving nouns for individual entities characterized as small, from nouns (as in *bábóg* doll from *báb* baby, or *béalóg* gap, muzzle, mouthful from *béal* mouth) or from adjectives (*bog* soft - *bogóg* shell-less egg; *ciar* dark - *ciaróg* beetle). It is consistently feminine. Derivations like *meabhróg* thoughtful girl from *meabhair* mind or *plandóg* shapely woman from *planda* plant suggest a female-denoting function; however, Ó Curnáin's overview of Irish word formation (2016: 2796) explicitly characterizes it as predominantly non-personal, adding that it is particularly common in Ulster varieties (some examples are *tonnóg* duck, *beachóg* bee, *sopóg* sheaf, *bachóg* sprout). In sum, a reasonably common noun-forming suffix expresses the feminine gender value consistently and yet independently of semantic motivation (it is compatible with, but not restricted to, female reference).⁴ But then it is not nouns in general, as a lexical category, which are losing gender as a lexically fixed grammatical property.

3.2 NO MALE-FEMALE PAIRS

A second consideration that points in the same direction is not just morphological but also semantic in nature. It seems to be a fact (a claim subject to falsification) that Irish simply lacks what Harris (1991) called mated nouns. These are pairs of nouns for animate referents which have the same stem, but opposed gender values corresponding to male and female reference. The two nouns may differ in inflection, like the Spanish *el niño* - *la niña* the boy - the girl, or have identical shape but only differ in gender value, like Spanish *el testigo* - *la testigo* the (male) witness - the (female) witness or French *le journaliste* - *la journaliste*. Bearing in mind the variability of gender assignment we have seen, it is striking that person- or animal-denoting nouns should not be the most likely candidates for creating gender-opposed pairs. Yet, of all nouns that can be masculine or feminine (most inanimates), none to my knowledge has turned into a lexical pair where the gender value strictly corresponds to biological sex. In fact, some facts suggest precisely that the gender of D cannot be decoupled from that of N and based on the reference of DP. One of the nominalizations in *-óg* just discussed is *piteog* effeminate man, sissy, from *pit* vulva (Ó Curnáin 2016: 2794). De Bhaldraithe (1977: 3) also mentions this derivation (translated in the glossary as man interested in women's affairs), adding that this is a word which is only said with men [translation PA]; it immediately precedes another derivation where grammatical gender conflicts with natural gender, namely *raibiléara* harlot, a masculine derivation which is only said with women. A noun like *piteog*, referring to an animate individual which is necessarily male (as a matter of lexical concept, not accidentally) is surely the best candidate for having semantic gender override grammatical gender. Yet this does not seem to happen (see also *bológ* mentioned in footnote 5). These cases parallel the Italian derogatory feminine term *checca* effeminate male homosexual which Percus (2011: 192) recognizes

⁴ Ó Curnáin (2016: 2796) also mentions the Ulster loanword *bológ* bullock (a male referent).

as incompatible with his generalization that, in Italian, nouns entailing maleness (unlike person) are feminine.⁵ The conclusion is clear: Irish grammar cannot just select the gender value of a DP on the basis of the semantic motivation of gender assignment. No matter how unstable gender morphology might be, the semantic value expressed on D cannot be detached from the value morphologically expressed on N; there is no *le / la journaliste*.⁶

The puzzle, then, stands in these terms. On the one hand, the gender assignment of nouns is unstable in significant parts of the nominal lexicon, and feminine gender marking shows signs of being quite often suspended specifically on nouns, as opposed to articles. On the other hand, there are no signs that grammatical gender on nouns is being replaced by a semantically-determined assignment of value based on the reference of DP; on the contrary, Irish lacks constructions where gender is determined at DP level overriding the grammatical gender on the noun, something which happens in other languages.

4 MAKING (SOME) SENSE OF THE PUZZLE

The solution I propose is more a reinterpretation, which seeks to do justice to the generalizations considered, than an explanation of all the data. It rests on two assumptions:

- gender is a grammatical property of Irish nouns, also represented on articles and adjectives by agreement
- nouns are not syntactic atoms, but have an internal structure which is syntactically represented

The first assumption states that, despite all signs of instability, gender should still be seen as a grammatical feature operative inside DP, and has not been reduced to an English-style DP-level categorization for referents. This was motivated in the previous sections and will not be argued for in what follows. We can now focus on the second proposition.

⁵Percus (2011: 192) opts to keep the generalization but interpret the entailment as referring to entities that are either females or like females in certain relevant respects. This plays down the fact that such terms highlight precisely the contrast between the referent and the gender value of the noun: the fact that the noun refers to males is not linguistically irrelevant but essential for lexical meaning.

⁶The apparent lack of mated nouns is one of the factors that make it difficult to resort to ellipsis phenomena to investigate the status of gender on nouns. In the general absence of pairs where gender minimally distinguishes readings like uncle-aunt, male-female teacher, or actor-actress, we cannot use patterns like He is a good N_{MASC}, but she is also [a good N_{FEM}] to test whether the gender marking can be teased apart from the noun under ellipsis (see Merchant 2014 for a study of Greek which concludes that not only does the status of gender differ across lexical classes, but ellipsis itself is in fact two distinct phenomena). Another factor is that the Irish pronominal equivalent of one is *ceann*, which to my knowledge is never sensitive to the gender of its antecedent. That said, it is likely that a study of noun ellipsis in Irish will find alternative ways to bring some facts to bear on the issue. I thank Jason Merchant for this insightful suggestion, which I cannot pursue here (but might be pursued by others).

from the usage of words, sharply different in nature from gender-form pairings that are explicitly part of the grammar.

This, then, is what the articles and gender-specific suffixes have in common: they both directly spell out a gender value (in addition to the rest of their content). By contrast, the noun endings compatible with masculine or feminine may be more or less strongly associated to one value, but they do not realize it as an exponent realizes a grammatical feature.

4.2 INITIAL MUTATIONS: LENITION

Initial mutations, and specifically lenition, have different properties, which make it a different type of exponent than a segmental morpheme like the suffix *-óg* or the form of the genitive article *na*. Like nasalization, lenition is a multi-purpose marker used to express a variety of grammatical contents, triggered by morphemes as diverse as preverbal particles, lexical verbs, pronominal particles (possessive and vocative), articles, and lexical nouns.⁷ There are lexical exceptions in some of these uses, and especially in the case at hand it is not always clear whether a noun displays no lenition (on its onset, following the article *an*, or on the onset of a following adjective) because it is masculine rather than feminine as expected, or because lenition simply fails to apply (see Ó Curnains 2007 comment cited above in section 2.3). The issue is further complicated by subregularities like the fact that adjectives in placenames are often unlenited (*Leitir Mór*, *Sraith Salach*, cited by de Bhaldraithe 1977: 273; see 5.1 below). In addition, the realization of initial mutation is sensitive to linearity in a way that sets it clearly apart from segmental exponents. It is well known that an intervening adverb blocks the regular lenition induced on the adjective *maith* good by a feminine noun like *Gaeilge* Irish (language), as shown in (9); however, Ó Siadhail (1989: 117) contrasts this intervention effect with a datum like (10) from the Donegal variety (in the context of a discussion about continued lenition which is described as happening in a few cases):

- (9) *Gaeilge mhaith* – *Gaeilge réasúnta maith*
Irish [LEN]-good – *Irish reasonably [NON-LEN]-good*
 good Irish – reasonably good Irish
- (10) *Gaeilge iontach mhaith*
Irish wonderfully [LEN]-good
 very good Irish

Finally, a following adjective is lenited much more regularly than a following noun (a genitive dependent). This is because when a common noun specifies a feminine noun (for proper names see 5.1 below), an asymmetry arises between expressions of a part-of relation, which do not generally lenite (as in (11)), and

⁷Carnie (2008: 7) aptly distinguishes four subtypes of lenition, rather than defining one and then stating the idiosyncrasies that arise in different morphosyntactic contexts.

other genitive constructions which do (as in (12); both taken from de Bhaldraithe 1977: 262-263):

- (11) Adharc pocaide
horn billy-goat.GEN
 A billigoats horn
- (12) Deoch bhainne
drink milk.GEN
 A drink of milk

This asymmetry is well documented, and indicates that the lenition on a dependent noun must be sensitive to syntactic and semantic factors which break down this configuration into a number of distinct subcases; see de Bhaldraithe (1977: 262-266), Ó Siadhail (1989: 121), Ó Sé (2000: 61-63), and especially Ó Curnáin (2007: 1737-1747). The distribution is complicated and probably less than systematic, since de Bhaldraithe also lists on the same page *aimsir gaoith anoir* weather of-wind from East, with no lenition, and *aimsir bháistí* weather of-rain, with lenition. Whatever underlying pattern explains the alternating presence and absence of lenition in this configuration, in the sources just mentioned it reflects a genuine property of native linguistic competence. This stands out clearly when it is contrasted with the occurrence of lenition on adjectives, as witnessed in the same sources. For these reasons, I will set aside the whole issue of lenition marking on a dependent genitive noun, which varies according to independent (if, for this writer, unclear) syntactic and semantic factors. What matters more directly for the question of gender marking is instead the lenition of attributive adjectives; and in this connection we have seen that lenition is relatively regular in traditional varieties, but is infrequent and shows strong signs of collapsing judging by the data in Frenda (2011).

All of these properties suggest that lenition has an indirect relation with the realization of gender; not only because it also realizes other grammatical contents, but because even as an exponent of gender it prone to being omitted, or overgeneralized, or realized only on one link of the agreement chain rather than on all agreeing elements. Gender involves the choice of forms in an agreement configuration, and gender values identify agreement classes. There is, then, a purely morphological side to it (the forms selected) and a syntactic side (the agreement configuration). In syntactic terms, we can represent the structure containing the noun controller and the two potential targets for gender agreement in the following standard notation, where the controller values the feature representations of the targets D and Adj (I specify the case on D as genitive, but it could be nominative/accusative):

- (13) [D_[Gen:__, Num:__, Case:Genitive]] [N_[Gen:Fem, Num:Sg] Adj_[Gen:__, Num:__]]]
 →
 [D_[Gen:Fem, Num:Sg, Case:Genitive]] [N_[Gen:Fem, Num:Sg] Adj_[Gen:Fem, Num:Sg]]]

These featural representations are spelled out by the appropriate morphemes, and the lexical root in the case of N and Adj (where N is a shorthand for a more complex structure, as discussed in 4.1 above). A form like *na* realizes gender, number, and case on D (in case the feature values are feminine, singular, and genitive), but otherwise gender does not find a specific morphological realization (excepting the specific feminine forms of the adjective, nowadays rare, illustrated by *bhige* in (4) above). In particular, N lacks a dedicated exponent for this feature, unless it contains a suffix explicitly marked for a gender value, like *-óg*. My suggestion is that lenition should be seen as a morphological formative which is conditioned by (among other triggers) the feminine gender value on the feminine singular form of D, N, and Adj (for D, also nominative/accusative), but which can fail to be expressed even though the feature value is still syntactically present. As a secondary exponent (Noyer 1997), it accompanies the morphological spellout of an abstract lexical and syntactic representation, specifying word forms in ways that can only take effect when the abstract representation has been linearized – as seems natural for a morpheme that is only visible as a sandhi phenomenon. Lenition, as a specification of word forms, is then a reflex of the feminine gender value on a whole agreement chain, and only becomes *the* exponent of this feature value when no other morphemes spell it out on the same chain; for instance, in a structure like *an bhean bhocht* the poor woman. This, I think, is the difference between lenition and the more usual exponence of feminine by means of morphemes like *na* and *-óg*: it is in principle a side-effect of the marking [Gender: Feminine], and in this sense it is more loosely related to this marking than inherently feminine morphemes. It can, then, be subject to oscillations in use, independently of the truly feminine morphemes and of the syntactic marking [Gender: Feminine] on the whole DP (as long as this is recoverable on at least some element). So, for instance, in (12) lenition may fail to appear, while the feature value is there and conditions the choice of the article form *na*. In addition, lenition may surface only on some of the chain links on which it is licensed: supposing that it may appear on N but not on D (which by hypothesis is still feminine), this would model what happens in inconsistent phrases like an *t-eolas* (the knowledge, no lenition) but *eolas mhaith* (good knowledge, with lenition on the adjective following *eolas*), without needing to posit two distinct gender assignments for the noun.

4.3 INITIAL MUTATIONS: GENERALIZING THE APPROACH

The idea that lenition is not a direct sign of feminine gender, and so that if it is missing it does not mean that the gender is not feminine, effectively would allow us to reinterpret a significant part of the attested instability in gender marking as instability in the realization of the featural input, and not as genuine oscillation in gender assignment. The approach generalizes: once the principle is accepted that initial mutations are a different sort of exponent from dedicated morphemes, with a looser relation to morphosyntactic features, we can look in the same way at other juncture phenomena, other than lenition, which likewise seem to denote

an irregular choice of gender value according to the tables in (12).

If a speaker hesitates between an *t-iascach* and *an iascach* (the fishing) in the same utterance, as Ó Curnáin reports (2007: 500), it is possible that the first form of the article *an t-*, simply recruited the prevocalic *t-* of the masculine as a hiatus-avoiding strategy, rather than being a genuine gender marker. It certainly seems more plausible that speakers should hesitate about such sandhi phenomena, than about the gender of nouns. The same would apply to the string *an t-iomaire mhór* (see 2.2 above), where the two apparently contradictory markings appear side by side.

The hypothesis that lenition may be to some extent decoupled from feminine gender is of course still compatible with the idea that feminine is simply lost in some (or many) cases. Ó Curnáin (2007: 506) identifies a tendency towards gender depletion for younger generations of speakers, resulting in feminine being no longer realized because it is simply no longer there. There is no need to dispute this interpretation, as long as the data are compatible with a generalized masculine morphology and do not at the same time suggest that feminine is still there, but only partially expressed. The (intended) strength of the reinterpretation I have offered is that it allows us to account for some of these more puzzling data, not only because the lack of lenition does not automatically imply lack of feminine gender, but also because it could be D or N that fail to lenite despite being feminine. If Ulster varieties usually treat *tír* land as a feminine (genitive *na tíre*), but feature an irregularly non-lenited adjective in the phrase *tír mór* mainland, literally big land (see again 2.2 above), it seems more plausible that lenition is simply suspended, especially in similar collocations, rather than thinking of an unstable gender value for this noun. In particular, a generalized retreat among younger speakers from the lenition triggered by N, as opposed to that triggered by D, would model the pattern found by Frenda (2011), with feminine gender agreement between N and Adj much less frequent than that between D and N (respectively 42% versus 87%, discounting the few proper names).

Again I must emphasize that this is not intended to explain away all the grey areas in Irish gender marking as an only apparent puzzle, because many cases are still better viewed as inconsistent assignments of gender value. Ó hUiginn (1994: 563), for a final example, cites for Connacht the two forms of the noun *bróigín*, formed by the diminutive *-ín* on the feminine (in *-óg!*) noun *for* shoe: in the nominative, the suffix regularly retains the gender of the base noun, resulting in the feminine *an bhróigín* (with lenition on N triggered by the article). But he adds that the genitive of the same noun behaves like a masculine in the phrase *barr an bhróigín* the tip of the shoe where lenition appears on *both* nominative and genitive, so it does not surface too little but, if anything, too much; the morphologically feminine noun in question simply has a masculine genitive (in that phrase).

This sort of cases might suggest that lenition too, like *t*-insertion, might sometimes act just like a sandhi phenomenon detached from the exponence of gender, especially in common collocations like *cleachtadh mhaith*. Such sequences, then, would no longer count as evidence for a feminine value of the noun. I sug-

gest that this is probably the correct interpretation in at least some cases, but with the essential qualification that it cannot be accepted as an explanation without independent reasons for thinking that the noun is not feminine. Otherwise, simply claiming that lenition, effectively, doesn't count in some cases (the problematic ones) would deprive the proposed interpretation of all predictive power. As I don't have independent evidence to bring to bear, I will simply mention this possibility without pursuing it.

Gender marking on Irish nominals is, objectively, messy. I have proposed an interpretive framework that can help make sense of this messiness: the irregularities concern some nouns more than others because of their morphological make-up,⁸ and they have substantially to do with lenition not appearing where it would be expected to. Alternative interpretations, especially the restatement-like position that, on the face of the facts, it is more economical to simply accept inconsistent gender assignments, should explain why this does not happen when initial mutation is not an exponent. I have not proposed that the irregularity is an epiphenomenon, but I have suggested that it would not be so common if nominal gender did not rely so much on initial mutations and other sandhi phenomena for its realization.

5 TOWARDS A THEORETICAL PROPOSAL

The analytic perspective suggested faces the challenge of organizing the often inconsistent data in a coherent model of grammatical competence. As a step towards that goal, this final section argues that the unsystematic application of lenition is an independent fact, and it briefly frames the analysis proposed in terms of the abstract structure of Irish nouns as morphological words.

5.1 THE INSTABILITY OF NOMINAL LENITION

I have claimed that the morphology of gender in Irish nominals looks so unsystematic because its exponence relies so much on lenition, and lenition is by itself unstable as an exponent. In working towards a theoretical account of Irish nominal gender, it is important to stress that this is an independently given datum, not a stipulation.

In (9)-(10) (section 4.2) we hinted at the fact that lenition triggered on an adjective by a preceding noun is sensitive to linearly intervening adverb. This well-known intervention effect (Ó Siadhail 1989: 117) shows by itself that word-initial mutation can be suspended in a way that would be unusual for affixal morphological markers. But it is also well known that lenition is sensitive to lexical choices. Ó Siadhail's all-dialect overview (1989: 114, 117) lists *méid* amount, *Dé* day (in names of the days of the week), and *tí* place, dwelling-place as regularly unlenited (see 2.1 above for Ó Curnáin's more precise statement about *méid*); in ad-

⁸ The case of *bróigín*, nominalized with *-ín*, finds an echo in the irregularly feminine *na cailín* of the girl, which Ó Curnáin (2007: 505) calls most aberrant.

dition, the lenition of the attributive second noun in a sequence Noun 1 - Noun 2 [genitive] is sometimes suspended, especially in traditional petrified phrases like *crích Banba* the land of Banba, or where the first noun has quasi-prepositional value, as in *lár mí an Meithimh* the middle of June. These are fixed collocations, and therefore they have a special status; still, by itself being a fixed collocation does not necessarily cancel the internal syntactic structure of a lexicalized phrase (proper names are certainly not immune from lenition). In addition, many fixed collocations, even petrified as place-names, preserve genitive forms, like *Drom Domhnaigh* (Dromdowney), County Cork, the ridge of the church, from *domhnach* church (<https://www.logainm.ie/719.aspx>).

These data independently confirm the conclusion reached in the past section: lenition realizes gender in a fashion that is less regular and systematic than affixes. It makes sense, then, to attribute a substantial role in the attested instability of nominal gender morphology to the instability of lenition (and other mutations) as a morphological marker. At least some of the puzzling cases where a noun seems to have masculine value (without lenition) after the nominative/accusative article *an*, and feminine (with article *na*, again without lenition) in the genitive, may well have this explanation. In other cases too, a noun that is syntactically marked feminine, with the corresponding forms of article, might fail to trigger lenition on a following adjective simply because lenition is suspended. This is not the explanation for all cases, as noted, but I propose it is a part of it.

5.2 LENITION AND THE MORPHOLOGICAL STRUCTURE OF NOUNS

We can go one more step towards a theoretical proposal. Let us not forget that the instability in question concerns not gender morphology in general but specifically the exponence of gender in DPs (in the sequence *Det N Adj*). But it does not extend to pre-nominal possessive particles, which in the third person involve *only* alternative initial mutation effects (except in front of vowel-initial nouns, the pronunciation of the particle *a* in fact coincides with that of the article forms spelled *an*):

- (14) a. A peann
 POSS pen
 Her pen
- b. A pheann
 POSS [LEN]pen
 His pen
- c. A bpeann
 POSS [NAS]pen
 Their pen

Granted that lenition and initial mutations are less than totally deterministic as morphological exponents, how are we to make sense for the additional observa-

tion that this concerns so specifically articles, nouns, and post-nominal adjectives inside DP, but not possessives?

The answer I suggest is that the Irish gender opposition is perfectly sound in the pronominal system as a determination of morphemes (including possessives) that express a referential index, but it is receding from the representation of nouns and, possibly less strongly, of articles, as morphological words. It is not as a global morphophonological phenomenon that mutations are becoming less regular (at least not for native competent speakers), but as formants in the representation of words as morphological objects; specifically, of nominal words, nouns and adjectives. This statement encapsulates the claim that lexical items are represented as structured symbols not only as syntactic objects, but also as abstract morphological objects which feed phonological realization. While this is assumed by, or is at least compatible with, most approaches to morphology, it is not a claim universally accepted. It is implied, for instance, by those analyses that follow Harris (1991) in positing word-markers as vocalic right edges of lexical words, required for morphological well-formedness: such would be the final *-o*, for instance, which in Italian closes off a noun endowed with the feature values of masculine and singular, like *cavallo* horse, but also a non-inflected adverb like *quando* when. Such formants are mandated by the morphology of the language, and not by syntax or phonology, witness the numerous consonant-ending loan-words like *sport* or *pus* (also masculine and singular) which are syntactically inflected for pronominal features but do not realize them morphologically through a vocalic ending (see Acquaviva 2009). In a similar vein, we can view the initial lenition triggered by feminine singular non-genitive nouns as a constituent of a linearized morphological representation:

- (15) *syntax* > *morphology* > *phonology*
 YEAR_[f.sg] bliain_[LEN] /b'l'iə n' / (+ lenition)

For a word like *bliain* year, the information that the gender value is feminine is not encoded by a feminine affix (or through the choice of a declension class associated with feminine by default). It rather surfaces as a juncture effect, as a global property of the word in certain phonological and syntactic environments. My hypothesis is that this property, represented as [LEN] in (16), is obliterated much more easily in these circumstances than in the case of nouns ending in a suffix that consistently spells out the feminine value, like *-óg*. The formant [LEN], in other words, is stable on words that are *morphologically* marked as feminine, where it is a side effect of feminine marking. But where a gender value is not explicitly marked by a suffix, it ends up having no direct exponence. Ultimately, this is because Irish nominal morphology does not seem to define declension classes that are truly consistent in the choice of gender (see Carnie 2008), especially when one considers the extremely reduced two-case paradigm and the fact that genitive forms are used less and less.

Articles are different. As functional words, they associate directly a featural content with a form, which is unique for a given choice of feature values. There is no lexical, word-depending variability in morphological structure. We then

predict that lenition and other initial mutations should prove more stable as an exponent of gender agreement between article and noun, than between noun and adjectival modifier. Still, the instances of missing or wrong mutation triggered by articles call for some explanation, over and above the fact that lenition can be suspended. The missing piece of explanation might lie in the demorphologization of such mutations after articles, which increasingly often are used as phonotactic juncture elements rather than gender exponents. This would be consistent both with the evidence (occasional) for hesitation and inconsistent choices by speakers, and with the theoretical claim that articles should retain more robustly than lexical nouns the property of triggering a mutation on a following word onset.

6 CONCLUSION: GENDER, SYNTAX, AND MORPHOLOGY

The morphology of noun gender in Irish is significantly unsystematic in the speech of the most competent native speakers. In the face of this, it makes sense to think that this category has changed its status in the morphology of the language, with a shift towards a semantically-based system. In current theoretical parlance, this would be analyzed as a shift in the role of gender from concord-to index agreement (see Lindau 2016). The foregoing sections have articulated reasons for believing that this seemingly plausible interpretation is not correct. Even though gender can be assigned on a semantic rather than purely morphological basis in pronominal anaphora (and even in this case, the semantic classes do not reduce to sex), a morphological gender opposition is still robust in Irish grammar, also in the morphology of articles, nouns, adjectives. The irregularity evidenced by various sources in recent varieties is an undeniable fact; but it centres, I have argued, on the distribution of initial mutations, specifically lenition. This suggests a weakening between this type of exponence and the expression of gender value, rather than a weakening of the gender category. The change is morphological, not morphosyntactic.

A conclusion like this, correct or incorrect, could not be stated without a clear distinction between the syntactic and the morphological dimension of a phenomenon like gender. The need for both dimensions of representation, then, is the broader theoretical conclusion arising from our narrowly-focused study. More specifically, I have claimed that the abstract representation of a word that feeds phonological spell-out, with its full complement of features, can differ from the representation we know as morphological word. It is not just that lenition may fail to apply; it may fail to apply especially when its trigger is a lexical noun. I have proposed that this reflects a gradual shift in the morphology of Irish nouns, whose morphological representation (unlike that of possessive particles, for instance) can lack the ability to trigger lenition. The latter is understood as a property of words as morphological (not syntactic) objects, like having an inflectional ending or a prefix, or a word-closing affix. As a result, the morphology of gender on N is different from that on D, although the two share the same feature

values. But such an asymmetry is not surprising. In realizing the same set of inflectional features, determiners often define morphological paradigms organized differently from those of lexical nouns (and adjectives). French is an illustration. Here, determiners oppose an invariable plural (*les, ces* /le/, /se/) to a gender-differentiated singular (*la - le, ce-cette* /la/ - /lə/, /sə/ - /set/). By contrast, adjectives, personal pronouns and those nouns that have a masculine and a feminine alternant either have no opposition (like *joli, jolie, jolis, jolies*, all /joli/), or they primarily oppose masculine and feminine, and only in some cases specify a number form inside a determinate gender value, like *nouveaux* /nuvo/, which can only be masculine and plural. This is shown in (17)-(18):

- (16) French determiners: primary number opposition, secondary gender opposition

le, ce, mon - les, ces, mes

MASC SG	MASC PL
FEM SG	FEM PL

lə, sə, mō	le, se, me
la, set, ma	

- (17) French nouns/adjectives: primary gender opposition, secondary number opposition

plein, écrit, il/elle - plein<z>, écrit<z>, il<z>/elle<z>

MASC SG	MASC PL
FEM SG	FEM PL

plœ̃, ekvi, il
plɛn, ekvit, ɛl

- (18) *principal, nouvel - principaux, nouveaux*

MASC SG	MASC PL
FEM SG	FEM PL

pʁɛ̃sipɔ, nuvo
pʁɛ̃sipal, nuvɛl

This familiar example shows that there is nothing unusual in having morphology organize differently across D and N the syntactic featural information shared between the two. But the difference is not to be construed as if the non-morphological information were automatically semantic in nature. The Irish facts, especially with the constant feminine gender of male-denoting nouns like *piteog* (see 3.2), clearly show that what lies behind the weakening of gender morphology on nouns is not a reduction to semantic-based assignment. This is relevant to current debates about gender in natural language, which distinguish between an interpretable and a purely morphological value for this category. A more nuanced approach would distinguish the mechanisms for gender assignment, which may be based more on the form or on the content of a linguistic representation, from the properties of the representation itself. Within these properties, gender has a syntactic and a morphological facet. The instability of Irish nominal gender, I have argued, concern the latter.

REFERENCES

- Acquaviva, Paolo. 2009. The structure of the Italian declension system. In Fabio Montermini, Gilles Boyé, and Jesse Tseng (eds.), 6th Décebrettes: Morphology in Bordeaux. 5062. Cascadilla Proceedings Project, Somerville, Mass.
- Aronoff, Mark. 1994. Morphology by itself. Cambridge, Mass.: MIT Press.
- Borer, Hagit. 2005. In name only. Oxford: Oxford University Press.
- CO 2001[1958] = Gramadach na Gaeilge agus litriú na Gaeilge: an caighdeán oifigiúil. Dublin: Oifig an tSoláthair, Rialtas na hÉireann.
- Carnie, Andrew. 2008. Irish nouns. A reference guide. Oxford: Oxford University Press.
- De Belder, Marijke, Noam Faust, and Nicola Lampitelli. 2014. On a low and a high diminutive. In Artemis Alexiadou, Hagit Borer, and Martin Schäfer (eds.), The syntax of roots and the roots of syntax. Oxford: Oxford University Press, 149163.
- de Bhaldraithe, Tomás. 1977 [1953]. Gaeilge Chois Fhairrge: an Deilbhíocht [The Irish of Cois Fairrge: Morphology]. Baile Átha Cliath: Institiúid Ard-Léinn Bhaile Átha Cliath.
- Déchainé, Marie-Rose. Raphael Girard, Calisto Mudzingwa, and Martina Wiltschko. 2014. The internal syntax of Shona class prefixes. Language Sciences: 1846. <https://doi.org/10.1016/j.langsci.2013.10.008>
- Doyle, Aidan. 1992. Noun derivation in Modern Irish. Lublin: Redakcja Wydawnictw Katolickiego Uniwersytetu Lubelskiego.
- Frenda, Alessio. 2011. Gender in Irish between continuity and change. *Folia Linguistica* 45, 2: 283 - 316.
- Harley, Heidi. 2014. On the identity of roots. *Theoretical Linguistics* 40, 3/4: 225276.
- Harris, John. 1991. The exponence of gender in Spanish. *Linguistic Inquiry* 22,1: 2762.
- Hughes, Art. 1994. Gaeilge Uladh [Ulster Irish]. In McCone et al. (eds.), 611660.
- Landau, Idan. 2016. DP-internal semantic agreement: A configurational analysis. *Natural Language and Linguistic Theory* 34/3: 9751020. Luís and Bermúdez-Otero (2016). The Morpheme debate. Oxford: Oxford University Press.
- McCone, Kim, Damian McManus, Cathal Ó Háinle, Nicholas Williams, and Liam Breatnach (eds.). 1994. Stair na Gaeilge [History of Irish]. Maigh Nuad: Roinn na Sean-Ghaeilge, Coláiste Phádraig.
- Merchant, Jason. 2014. Gender mismatches under nominal ellipsis. *Lingua* 151: 932.
- Noyer, Rolf. 1997. Features, Positions and Affixes in Autonomous Morphological Structure. Doctoral Dissertation, MIT.
- Ó Curnáin, Brian. 2007. The Irish of Iorras Aithneach, County Galway. Dublin: Dublin Institute for Advanced Studies.
- Ó Curnáin, Brian. 2016 Irish. In Peter Müller, Ingeborg Ohneiser, Susan Olsen, and Franz Rainer (eds.), Word Formation. Volume 4: Word-formation in the individual European languages. Berlin: de Gruyter Mouton, 27822810.

- Ó Dónaill, Niall. 1978. *Foclóir Gaeilge-Béarla*. Dublin: An Roinn Oideachais.
- Ó hUiginn, Ruairí. 1994. *Gaeilge Chonnacht* [Connacht Irish]. In McCone et al. (eds.), 538609.
- Ó Sé, Diarmuid. 2000. *Gaeilge Chorca Dhuibhne* [The Irish of Corca Dhuibhne]. Dublin: Institiúid Teangeolaíochta Éireann.
- Ó Siadhail, Mícheál. 1984. A note on gender and pronoun substitution in Modern Irish dialects. *Ériu* 35: 173177.
- Ó Siadhail, Mícheál. 1989. *Modern Irish: Grammatical structure and dialectal variation*. Cambridge: Cambridge University Press. Ua Suilleabháin, Seán. 1994. *Gaeilge Mumhan* [Munster Irish]. In In McCone et al. (eds.), 479538.
- Wigger, Arndt (ed.) 2000. *Caint Chonamara: Bailiúchán Hans Hartmann*, Vol. IX: Ros Muc, [The spoken language of Connemara: Hans Hartmanns collection, Vol. IX: Ros Muc]. Universität Bonn.

through operations reordering the subject and object.

We describe the inverse scenario. Santiago Laxopa Zapotec (SLZ) is, like other Zapotec languages, rigidly vso (see Sonnenschein 2004: 125 and López Nicolás 2016: 266 on closely related varieties).¹

- (1) Dzut nu'ule='n bene' xyage'=n.
hit.CONT woman=DEF CL man=DEF
 'The woman is hitting the man.'
 Not possible: 'The man is hitting the woman.' (FSR, SLZ57a-s, 1)

Nonetheless, we argue that it uses phrasal movement to derive its verb-initial word order, paralleling Lee's (2006) account of San Lucas Quiavini Zapotec (*pace* Black 2000: 92–95, Foreman 2006: 246–248). The absence of any word order alternation arises because all the verb's arguments must evacuate the constituent that moves.

The basic clause structure that we propose for SLZ is the one in (2). The subject and object—and any other verb-phrase internal constituents that can move—raise out of vP, which subsequently undergoes movement to Spec-TP.

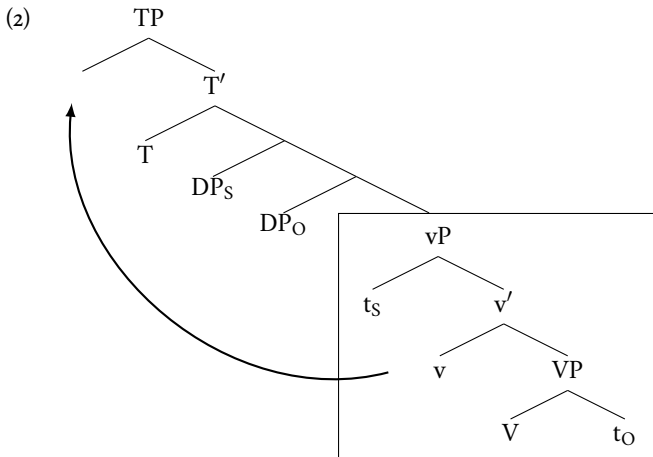

This rather abstract *predicate raising* analysis might seem difficult, if not impossible, to distinguish from a more concrete *verb raising* analysis, in which the verb alone raises to T. But we take inspiration from Jim McCloskey's work—say, on the number and type of subject positions (McCloskey 1997) or the derivational mechanism undergirding A'-dependencies (McCloskey 2002)—which shows how it is often possible to tease apart very similar analytical possibilities by examining subtle patterns of data in detail and with careful and precise argumentation.

¹The abbreviations we use are: AN = animal, CAUS = causative, CL = classifier, CONT = continuous aspect, COMP = completive aspect, DEF = definite, EL = elder, FREQ = frequentative aspect, HU = non-elder human, IN = inanimate, INCH = inchoative, HU = informal, INT = intensive, REP = repetitive aspect, SG = singular, STAT = stative aspect, POT = potential aspect.

2 SOME BACKGROUND ON SANTIAGO LAXOPA ZAPOTEC

Santiago Laxopa Zapotec (SLZ) is a Northern Zapotec (Oto-Manguan) language spoken in the Sierra Norte of Oaxaca, Mexico. We present data from three speakers from the town of Santiago Laxopa itself. We also include data from two speakers from the nearby towns of San Sebastián Guiloxi and Santa María Yalina. There are dialectal differences amongst these speakers, but we have observed no significant variation with respect to the syntactic phenomena under consideration. These southeastern Sierra varieties are most closely related to those of San Jerónimo Zochina (López Nicolás 2016) and San Bartolomé Zoogocho (Long & Cruz 2000, Sonnenschein 2004).

In SLZ, the subject is structurally superior to the direct object: it is able to asymmetrically bind an R-expression in that position, inducing a violation of Condition C (which has been shown to be active in other Zapotec varieties as well; Lee 2003).

- (3) a. Bdi'inn [beku' tse **Pedro**₁] **lleba**'_{1/2}.
bite.COMP dog of Pedro 3.HU
 'Pedro₁'s dog bit him_{1/2}.' (FA/RM, GZYZ019, 1:30)
- b. Betw=**ba**'_{s/1/2} [beku' tse **Pedro**₁].
hit.COMP=3.HU dog of Pedro
 'He_{s/1/2} hit Pedro₁'s dog.' (FA/RM, GZYZ019, 13:20)

Assuming that phrases are endocentric, and that the clause is the extended projection of the verb (Chomsky 1970, Grimshaw 2005), the verb and the direct object must form a constituent to the exclusion of the subject (*pace* Broadwell 2005).

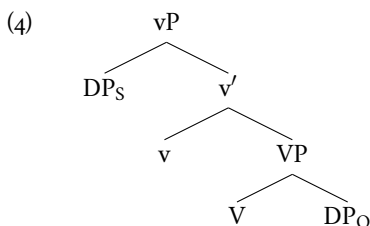

Assuming a fairly articulated structure for the verb phrase, the external argument is introduced in the specifier of a functional head, Spec-vP (Kratzer 1996).

There is evidence that the subject occupies a surface position outside of vP. The subject of an unaccusative verb (5) occupies the same position relative to manner adverbs that the subject of a transitive verb does (6).

- (5) a. Dz-i-yag Pedro **xtidao**'.
CONT-INCH-be.cold Pedro quickly
 'Pedro is getting cold quickly.' (FA/RM, GZYZ019, 1:19:07)
- b. *Dz-i-yag **xtidao**' Pedro.
CONT-INCH-be.cold quickly Pedro (FA/RM, GZYZ019, 1:19:20)

- (6) a. Udo *Juan=a'* yet=e'n **xtido'-yes**.
eat.COMP Juan=DEF tortilla=DEF quickly-INT
 'Juana ate tortillas very quickly.' (FSR, SLZ1009-s, 21)
- b. *Udo **xtido'-yes** *Juan=a'* yet=e'n.
eat.COMP quickly-INT Juan=DEF tortilla=DEF
 (FSR, SLZ1009, 31:15)

Regardless of how verb initiality is derived, then, subjects must raise to a position below the surface position of the verb (see Lee 2006: 49 for additional arguments).

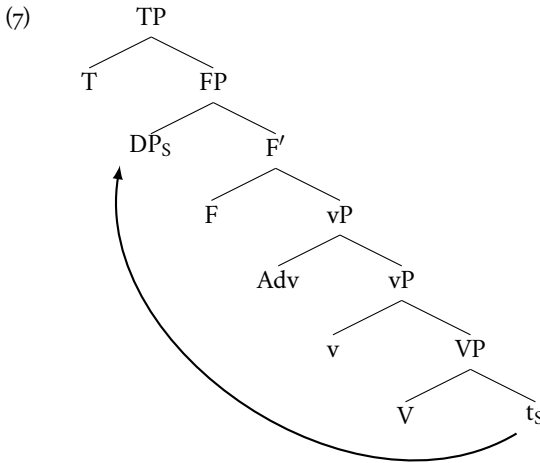

We call this projection simply FP. The subject raises into its specifier presumably to satisfy an EPP feature, receiving nominative case from T in that position.

The clause in SLZ is probably even more articulated than this, since verbs bear rich inflectional morphology, including aspectual, directional, number, and voice prefixes (Sonnenschein 2004: 118, López Nicolás 2016: 153). If these are heads, they must attach to the root in some way. We remain agnostic about whether this happens through head movement or a postsyntactic operation (see Lee 2006: 53–62).

3 TWO PATHS TO VERB INITIALITY

With this clause structure, there are at least two ways for the verb to surface in initial position. Either the verb undergoes head movement to T (8a), or a somewhat larger verbal constituent—say, vP—undergoes phrasal movement into Spec-TP (8b).

(8) a. *Verb raising*

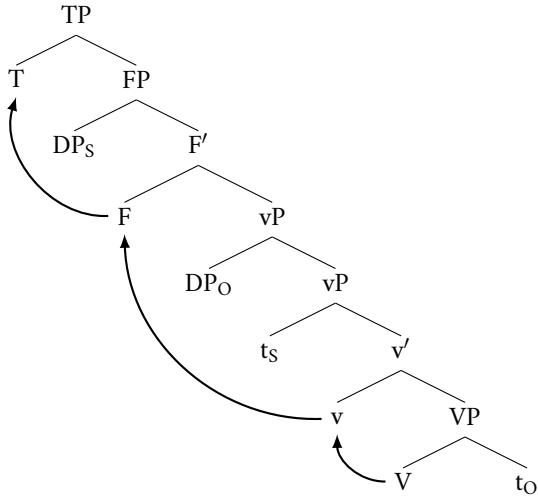

b. *Predicate raising*

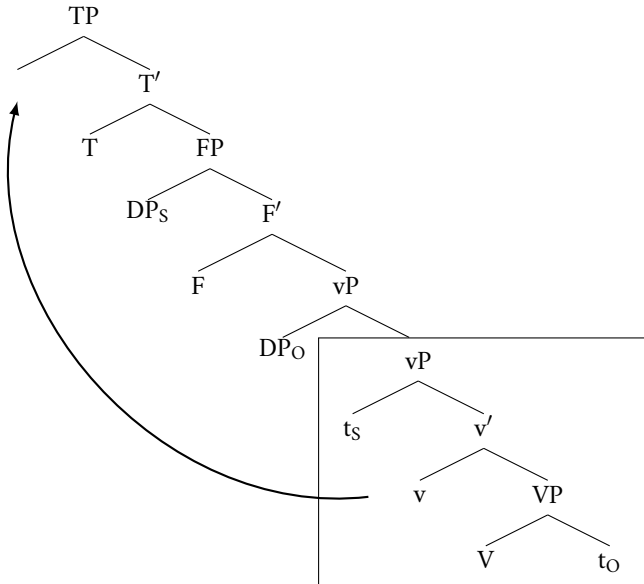

In the absence of a DP in Spec-TP, it is the verb or verb phrase that frequently is thought to satisfy the EPP on T (Massam & Smallwood 1997, a.o.).

As schematized above, the verb raising and predicate raising accounts share the assumptions laid out in Section 2. In particular, the subject must raise to a functional projection, FP, below the landing site of the verb. The difference between them, of course, is the size of the moved constituent. But to derive rigid vso word order, the predicate raising account further requires that the vP contain just the verb before it moves to Spec-TP. That is, any elements that cannot

appear between the verb and subject, such as an object, must evacuate this constituent before it raises to Spec-TP. As we show next, this kind of movement is independently available in the language.

While the position of the subject is fixed—it must be the first postverbal argument in the clause—the order of other clausal elements is flexible. Direct and indirect objects are more or less freely ordered amongst one another (9), as are any clausal complements (10) or adjunct PPs (11).

- (9) a. Ba be Maria **beku' bidao' ni**.
already give.COMP Maria dog child this
 'Maria already gave the dog to this child.' (RM/FA, GZYZ015, 18:13)
- b. Ba be Maria **bidao' ni beku'**.
already give.COMP Maria child this dog
 'Maria already gave the dog to this child.' (RM/FA, GZYZ015, 18:46)
- (10) a. Dze Pedro Maria [**bdi'inn beku' xna'=a'**].
tell.CONT Pedro Maria bite.COMP dog mother=ISG
 'Pedro told Maria that the dog bit my mother.'
 (FA/RM, GZYZ020, 2:07)
- b. ??Dze Pedro [**bdi'inn beku' xna'=a'**] Maria.
tell.CONT Pedro bite.COMP dog mother=ISG Maria
 (FA/RM, GZYZ020, 4:45)
- (11) a. Blo'ed Maria bidao' ni beku' **lo' yo'o**.
show.COMP Maria child this dog in house
 'Maria showed the dog to the child in the house.'
 (FA/RM, GZYZ019, 14:40)
- b. Blo'ed Maria bidao' ni **lo' yo'o beku'**.
show.COMP Maria child this in house dog
 (FA/RM, GZYZ020, 6:53)
- c. Blo'ed Maria **lo' yo'o** bidao' ni beku'.
show.COMP Maria in house child this dog
 (FA/RM, GZYZ020, 7:03)

This freedom recalls scrambling in the Germanic middlefield, which has been variously analyzed as base generation with flexible linearization and as movement to a functional projection or to adjoin to the verb phrase (see the survey in Haider 2006).

To maintain a straightforward mapping from syntax to phonology, we assume that the sentence constituents that exhibit flexible word order in (9)–(11) undergo movement to positions that are higher in the clause and are not internally ordered. For simplicity, we will allow them to simply adjoin to vP, though we are open to the possibility that they are instead specifiers of one or more functional projections. Importantly, for the predicate raising account, this movement must be obligatory, so that vP contains just the verb before it itself moves. While the

need for this additional assumption could be interpreted as an argument in favor of the alternative verb raising account, we reemphasize that the real question here is why major sentence constituents other than subjects are freely ordered. For similar facts in other languages, e.g., Germanic scrambling, the answer is not clear cut and often depends on higher, framework-level assumptions. So, in the absence of decisive arguments to the contrary, we see no harm in assuming that this movement in SLZ is obligatory.

Crucially, wherever these elements move to, it cannot be to a position that intervenes between the subject in Spec-FP and the position of the verb. A direct or indirect object cannot intervene between the subject and verb (12a–b); nor can an adjunct PP (13) or clausal complement (14).

- (12) a. * Ba be **beku'** Maria bidao' ni.
already give.COMP dog Maria child this
 Intended: 'Maria gave the dog to the child.'
 (RM/FA, GZYZ015, 18:46)

- b. * Ba be **bidao' ni** Maria beku'.
already give.COMP child this Maria dog
 (RM/FA, GZYZ015, 19:51)

- (13) * Blo'ed **lo'yo'o** Maria bidao' ni beku'.
show.COMP in house Maria child this dog
 Intended: 'Maria showed the dog to this child in the house.'
 (FA/RM, GZYZ019, 15:18)

- (14) * Dze [**bdi'inn beku' xna'=a'**] Pedro Maria.
tell.CONT bite.COMP dog mother=ISG Pedro Maria
 Intended: 'Pedro told Maria that the dog bit my mother.'
 (FA/RM, GZYZ020, 5:00)

We state this constraint on postverbal material as in (15); it prohibits any element from moving or adjoining between the verb and the subject.

- (15) *Adjacency Requirement in Santiago Laxopa Zapotec*
 No element can merge or move into a position between Spec-FP and T.

While this adjacency requirement might be a language-specific property, stemming from the simple absence of landing sites for movement between the verb and subject, this would not explain a potential crosslinguistic correlation with verb initiality.

McCloskey (1991: 260) observes that Irish exhibits a nearly identical restriction. He links it to case assignment: T must be adjacent to the DP to which it assigns nominative case, just as other case assigners—e.g., V, P, or C—must be adjacent to their assignees (Stowell 1981: 110–112 *et seq.*). We leave it to future work to determine the source of this constraint, though it will play an important role in choosing between the verb and predicate raising accounts of verb initiality.

Returning to the main issue at hand, it might now seem impossible to distinguish between the verb raising and predicate raising accounts, if all the elements inside vP can move out except V, thereby conflating the difference between moving a head and moving a phrase. But, in what follows, we identify several elements that can or must remain within vP: aspectual adverbs (Section 4), the adjectival predicate in a copular clause (Section 5), and the nonverbal element in a light verb construction (Section 6). These elements are able to move along with the verb, sometimes appearing between the verb and the subject, just as the predicate raising account predicts.

4 THE POSITION OF ASPECTUAL ADVERBS

Adverbs fall into at least three classes depending on their distribution. First, temporal adverbs, such as *neje* ‘yesterday’, *yuge’zha* ‘every day’, and *ne’ezha* ‘today’, can occur preverbally (16a) or anywhere postverbally (16c–d) except between the verb and the subject (16b).

- (16) a. **Neje** be’eye’ Maria=’n yetgu’=n.
yesterday steam.COMP Maria=DEF tamale=DEF
 ‘Maria steamed the tamales yesterday.’ (FSR, SLZo62-s, 50)
- b. * Be’eye’ **neje** Maria=’n yetgu’=n.
steam.COMP yesterday Maria=DEF tamale=DEF
 (FSR, SLZo62, 1:02:03)
- c. Be’eye’ Maria=’n **neje** yetgu’=n.
steam.COMP Maria=DEF yesterday tamale=DEF
 (FSR, SLZo62, 1:02:29)
- d. Be’eye’ Maria=’n yetgu’=n **neje**.
steam.COMP Maria=DEF tamale=DEF yesterday
 (FSR, SLZo62-s, 49)

Then there are manner adverbs, such as *xtido’* (or *xtidao’*) ‘quickly’, *cholzhe’e* ‘slowly’, and *zishje’* ‘loudly’, which have a superficially similar distribution to temporal adverbs.

- (17) a. **Xtido’-yes** udoo Juan=a’ yet=e’n.
quickly-INT eat.COMP Juan=DEF tortilla=DEF
 ‘Juan ate tortillas very quickly.’ (FSR, SLZ1009-s, 20)
- b. * Udoo **xtido’-yes** Juan=a’ yet=e’n.
eat.COMP quickly-INT Juan=DEF tortilla=DEF
 (FSR, SLZ1009, 31:15)
- c. Udoo Juan=a’ **xtido’-yes** yet=e’n.
eat.COMP Juan=DEF quickly-INT tortilla=DEF
 (FSR, SLZ1009, 29:10)

- d. Udoo Juan=a' yet=e'n **xtido'-yes**.
eat.COMP Juan=DEF tortilla=DEF quickly-INT

(FSR, SLZ1009-s, 21)

Finally, aspectual adverbs, such as *chintje'* 'just (now)', *ba* 'already', and *ne'e* 'still', can only appear immediately before the verb.

- (18) a. **Chintje'** bta Sonia='n zah.
just stir.COMP Sonia=DEF bean
 'Sonia just stirred the beans.' (RD, SLZ2012-s, 17)
- b. *Bta **chintje'** Sonia='n zah.
stir.COMP just Sonia=DEF bean (RD, SLZ2012, 43:14)
- c. *Bta Sonia='n **chintje'** zah.
stir.COMP Sonia=DEF just bean (RD, SLZ2012, 43:24)
- d. *Bta Sonia='n zah **chintje'**.
stir.COMP Sonia=DEF bean just (RD, SLZ2012, 43:28)

We call these aspectual adverbs, following Tenny (2000), because they appear sensitive to the internal structure of the event described by the verb. They can be contrasted with temporal adverbs, which simply locate the event in time.

We propose to account for the distributions of these three classes by adjoining them in different, albeit partially overlapping, positions.

- (19) *The position of adverbs in Santiago Laxopa Zapotec*
- i) Temporal adverbs can adjoin to vP or to CP.
 - ii) Manner adverbs can adjoin to vP or fill Spec-CP.
 - iii) Aspectual adverbs can only adjoin inside vP.

Under our present assumptions, both temporal and manner adverbs must be able to adjoin to vP, since they can be freely interleaved amongst any nonsubject arguments or adjunct PPs.

- (20) a. Blo'ed Maria **cholazhe'e** bidao' ni beku' lo' yo'o.
show.COMP Maria slowly child this dog in house
 'Maria showed the dog to this child in the house slowly.'
 (FA/RM, GZYZ020, 49:53)
- b. Blo'ed Maria bidao' ni **cholazhe'e** beku' lo' yo'o.
show.COMP Maria child this slowly dog in house
 (FA/RM, GZYZ020, 49:33)
- c. Blo'ed Maria bidao' ni beku' **cholazhe'e** lo' yo'o.
show.COMP Maria child this dog slowly in house
 (FA/RM, GZYZ020, 49:11)
- d. Blo'ed Maria bidao' ni beku' lo' yo'o **cholazhe'e**.
show.COMP Maria child this dog in house slowly
 (FA/RM, GZYZ020, 48:52)

- (21) a. Blo'ed Maria **neje** bidao' ni beku' lo' yo'o.
show.COMP Maria yesterday child this dog in house
 'Yesterday, Maria showed the dog to the child in the house.'
 (FA/RM, GZYZ019, 16:23)
- b. Blo'ed Maria bidao' ni **neje** beku' lo' yo'o.
show.COMP Maria child this yesterday dog in house
 (FA/RM, GZYZ019, 1:45)
- c. Blo'ed Maria bidao' ni beku' **neje** lo' yo'o.
show.COMP Maria child this dog yesterday in house
 (FA/RM, GZYZ019, 17:03)
- d. Blo'ed Maria bidao' ni beku' lo' yo'o **neje**.
show.COMP Maria child this dog in house yesterday
 (FA/RM, GZYZ019, 17:19)

The two classes come apart in preverbal position. While temporal adverbs adjoin to CP, appearing before a *wh*-phrase (23a–b), manner adverbs occupy Spec-CP, since they cannot cooccur before the verb either preceding or following a *wh*-phrase (22a–b). (In *wh*-questions, manner adverbs only surface postverbally.)

- (22) a. **Neje** bi de'e udoo Juan?
yesterday which thing eat.COMP Juan
 'What did Juan eat yesterday?' (ADR, SLZ1015, 7:23)
- b. *Bi de'e **neje** udoo Juan?
which thing yesterday eat.COMP Juan (ADR, SLZ1015, 7:39)
- (23) a. ***Xtido'** bi behle' dzoo Juan?
quickly which meat eat.CONT Juan
 Intended: 'Which meat is Juan eating quickly?' (ADR, SLZ1015, 4:03)
- b. *Bi behle' **xtido'** dzoo Juan?
which meat quickly eat.CONT Juan (ADR, SLZ1015, 4:25)

Returning now to the aspectual adverbs, their surface distribution is somewhat mysterious. Crosslinguistically, such adverbs typically occur below temporal adverbs (Cinque 1999, a.o.). This tendency is illustrated in 24–25: *today* can only adjoin high—to TP or CP—while *still* can only adjoin lower—to vP or below, perhaps.

- (24) a. **Today** Max is taking the bar exam.
 b. *Max is **today** taking the bar exam.
- (25) a. ***Still** Max is taking the bar exam.
 b. Max is **still** taking the bar exam.

While we do not fully understand the source of this pattern, one not implausible explanation is semantic. Since aspectual adverbs are sensitive to the internal

structure of the event described by the verb, they must be adjoined closer to it (Tenny 2000).

Under the predicate raising account, however, the inverted order of aspectual adverbs relative to temporal adverbs is unsurprising. If aspectual adverbs only adjoin inside vP, they always raise with the verb to Spec-TP, thereby appearing only to its left.

(26)

= 18a

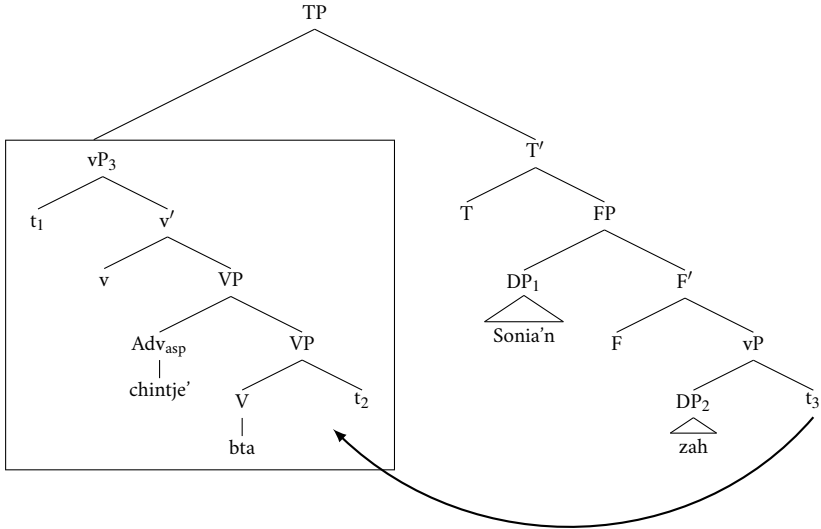

Moreover, aspectual adverbs are correctly predicted, unlike temporal adverbs, to be ungrammatical before a wh-phrase (27a), and unlike manner adverbs to be grammatical between a wh-phrase and the verb (27b).

- (27) a. * **Chintje'** nu nule'n ble'e Sonia='n?
just which girl see.COMP Sonia=DEF
 Intended: 'Which girl did Sonia just see?' (FSR, SLZ1014, 2:55)
- b. Nu nule'n **chintje'** ble'e Sonia='n?
which girl just see.COMP Sonia=DEF
 'Which girl did Sonia just see?' (FSR, SLZ1014-S, 2)

By contrast, under the verb raising account, the inverted pattern of aspectual adverbs in SLZ is unexpected. If they only adjoin inside vP, then the grammatical sentence in (18a) would incorrectly be predicted to be ungrammatical and the ungrammatical sentence in (18d) to be grammatical. The only recourse would be to assume that aspectual adverbs adjoin higher than temporal adverbs—for instance, to TP—but this would cut against the robust generalization about the hierarchical position of adverbs across languages. So, the position of aspectual adverbs, immediately preceding the verb in initial position, supports the predicate raising account over the verb raising account.

5 COPULAR CLAUSES

There are two copulas: *-sua* (or *-soo*) ‘be, live’ and *-ak* ‘be, happen’.² We focus on just the first here. In a copular clause, an adjectival predicate can either follow (28a) or precede (28b) the subject.

- (28) a. Zua **Pedro wen.**
be.CONT Pedro good
 ‘Pedro is well.’ (FSR, SLZ1014-s, 30)
- b. Zua **wen Pedro.**
be.CONT good Pedro
 ‘Pedro is well.’ (FSR, SLZ1014-s, 28)

We take the copula to be a verb, as it can host a subject clitic (29a) and aspectual morphology (29b). But it takes a small clause complement, comprised of the subject and a predicate.

- (29) a. Zoo-**to’** wen.
be.CONT-1PL:EXCL good
 ‘We are well.’ (RM, GZYZ001-s, 5)
- b. Ga **bzu-e’?**
where live.COMP-3EL
 ‘Where did s/he live?’ (RM, GZYZ040-s, 4)

The variable word order in (28a–b) follows straightforwardly under the predicate raising account if AP predicates can optionally undergo the same scrambling operation that DPs and PPs undergo obligatorily. When it moves out of vP, subject-predicate order arises (30a); when it does not, predicate-subject order arises (30b).

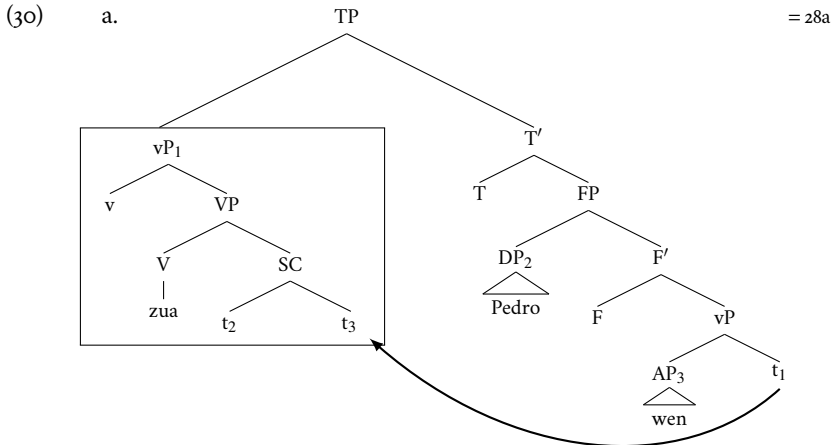

²Verbs in Zapotec have several aspectual forms; the citation form is a bound morpheme lacking aspectual morphology.

b.

= 28b

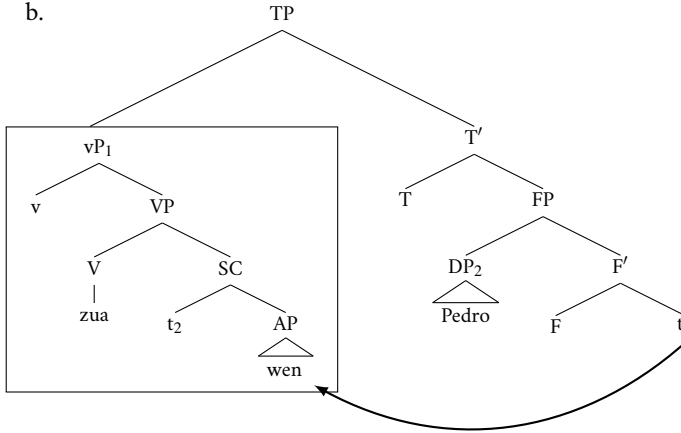

There is independent evidence that the adjectival predicate is capable of moving. Just like the subject (31a), it can move into a preverbal focus position (31b).

- (31) a. **Pedro** zua wen.
***Pedro** be.CONT good*
 'PEDRO is well.' (FSR, SLZ1014-s, 31)
- b. **Wen** zua Pedro.
***good** be.CONT Pedro*
 'Pedro is WELL.' (FSR, SLZ1014, 40:50)

Importantly, there is no violation of the adjacency requirement in (15) when the adjectival predicate intervenes between the copula and subject. As shown in (30b), it is contained within the constituent in Spec-TP.

This constraint is clearly still in effect in copular clauses. With subject-predicate order, a temporal adverb can occur in any position except between the vP in Spec-TP and the subject.

- (32) a. **Neje** [zua] Pedro wen.
***yesterday** be.CONT Pedro good*
 'Yesterday, Pedro was well.' (FSR, SLZ1014-s, 39)
- b. * [Zua] **neje** Pedro wen.
*be.CONT **yesterday** Pedro good* (FSR, SLZ1014, 55:28)
- c. [Zua] Pedro **neje** wen.
*be.CONT Pedro **yesterday** good* (FSR, SLZ1014, 55:34)
- d. [Zua] Pedro wen **neje**.
*be.CONT Pedro good **yesterday*** (FSR, SLZ1014, 55:42)

Similarly, with predicate-subject order, a temporal adverb is possible in initial (33a) or final (33d) position. But it is ungrammatical between the phrase in Spec-TP and the subject (33c).

- (33) a. **Neje** [zua wen] Pedro.
yesterday be.CONT good Pedro
 ‘Yesterday, Pedro was well.’ (FSR, SLZ1014, 56:00)
- b. * [Zua **neje** wen] Pedro.
be.CONT yesterday good Pedro (FSR, SLZ1014, 56:20)
- c. * [Zua wen] **neje** Pedro.
be.CONT good yesterday Pedro (FSR, SLZ1014, 56:27)
- d. [Zua wen] Pedro **neje**.
be.CONT good Pedro yesterday (FSR, SLZ1014, 56:34)

Note that, under this account, (33b) is ungrammatical because a temporal adverb cannot adjoin inside vP, in keeping with the proposal in (19).

While the verb raising account can derive subject-predicate order in (28a) through head movement of the copula, it cannot derive predicate-subject order in (28b). To do so, the adjectival predicate would have to move independently to a position between the copula in T and the subject, thereby violating the adjacency requirement. This, then, is another argument in favor of the predicate raising account.

6 LIGHT VERB CONSTRUCTIONS

There are light verb constructions in SLZ built from a *light verb*, *-un* (or *-on*) ‘do, make’ plus a *nonverbal element*, e.g. *-un yeze* ‘boast’, *-un lazhe* ‘lie’, and *-un tsgwa* ‘show off’ (lit. ‘make much’).³

- (34) a. **Dzun yeze** Pedro kar tse=ba’=n.
do.CONT boastful Pedro car of=3.HU=DEF
 ‘Pedro is boasting about his car.’ (FSR, SLZ1013-s, 11)
- b. **Dzon lazhe** Pedro nada’.
do.CONT lying Pedro 1SG
 ‘Pedro is lying to me.’ (FA/RM, GZYZ018, 1:25:03)

³This class of light verb constructions contrasts with another, superficially similar class that exhibits a different behavior (see Broadwell 2004 for a parallel contrast in another Zapotec language).

- (i) a. **Dzun shbab** Pedro tse nu’ule tse=ba’.
do.CONT thought Pedro of woman of=3.HU
 ‘Pedro is thinking about his wife.’ (FA/RM, GZYZ018, 57:34)
- b. **Dzun shchaj** Pedro=n.
do.CONT noise Pedro=DEF
 ‘Pedro is making noise.’ (FSR, SLZ1014, 1:30:56)

We set these light verb constructions aside because they allow for the nonverbal element to move independently, e.g., to a preverbal position. As expected, they also allow for the nonverbal element to intervene between the verb and subject, just as in a copular construction.

- c. **Dzon tsgwa** Pablo kar tse=ba'.
do.CONT much Pablo car of=3.HU
 'Pablo is showing off his car.' (lit. 'Pablo is making much of his car.')

(FA, GZYZ018, 45:50)

Crucially, the nonverbal element in these light verb constructions must occur immediately following the light verb, preceding the subject.

- (35) a. * **Dzun Pedro yeze'** kar tse=ba'=n.
do.CONT Pedro boastful car of=3.HU=DEF
 Intended: 'Pedro is boasting about his car.' (FSR, SLZ1013, 20:11)
- b. * **Dzon Pedro lazhe.**
do.CONT Pedro lying
 Intended: 'Pedro is lying.' (RM/FA, GZYZ018, 1:18:01)
- c. * **Dzon Pedro tsgwa** kar tse=ba'.
do.CONT Pedro much car of=3.HU
 Intended: 'Pablo is showing off his car.' (FA/RM, GZYZ018, 51:35)

Broadwell (2004) proposes that parallel light verb constructions in San Dionicio Ocotepec Zapotec are compounds. This seems unlikely for SLZ because some incorporated adverbs can intervene between the light verb and nonverbal element.⁴

- (36) a. **Dzun-tek yeze'** Pablo kar tse=ba'=n.
do.CONT-a.lot boastful Pablo car of=3.HU=DEF
 'Pablo is boasting a lot about his car right now.' (FSR, SLZ1016, 14:54)
- b. **Dzon-tek lazhe** Pedro.
do.CONT-a.lot lying Pedro
 'Pedro is lying a lot right now.' (FA, GZYZ020-s, 27)

⁴Two kinds of elements can encliticize to the verb: "incorporated" adverbs and pronominal clitics. While the former attach to the light verb (36a–c), the latter attach only to the nonverbal element.

- (i) **Dzun yez=a'** kar tsi=a'=n.
do.CONT boastful=ISG car of=ISG=DEF
 'I am boastful of my car.' (FSR, SLZ1013-s, 12)
- (ii) * **Dzun=a'** yeze' kar tsi=a'=n.
do.CONT=ISG boastful car of=ISG=DEF (FSR, SLZ1014, 59:07)

At least for the pronominal clitics, these are weak elements which must be licensed syntactically (Foley, Kalivoda & Toosarvandani, to appear-a, b). They are also selective about what their phonological host can be, which need not be a verb (Marlett 1993: 95). While they can attach to another clitic, forming a clitic cluster, they cannot, for instance, attach to an R-expression (Toosarvandani 2017: 131). While the licensing conditions for incorporated adverbs and pronominal clitics are germane here, we leave off further consideration for reasons of space.

- c. Dzon-**tek** tsgwa Pedro kar tse=ba'.
do.CONT-a.lot much Pedro car of=3.HU
 'Pedro is showing off his car a lot right now.'
 (FA/RM, GZYZ019, 1:25:20)

Instead, we might draw a parallel—somewhat speculatively—to light verb constructions in other languages, and in particular in Persian where they can be built from the light verb *kardan* 'do' and a nonverbal element.

- (37) Pâpâr Kimeâ=ro **bidâr kard**.
Papar Kimea=OBJ awake do.PAST.3SG
 'Papar woke up Kimea.'
 (Folli et al. 2005: 1375)

In Persian, the light verb is typically analyzed as the realization of *v*, since simply switching out *kardan* 'do' for another light verb can yield an unaccusative predicate. Its complement, then, is headed by the nonverbal element (Folli et al. 2005).

With this structure, the position of the nonverbal element immediately after the light verb follows directly from the predicate raising account. The nonverbal element can move along with the light verb.

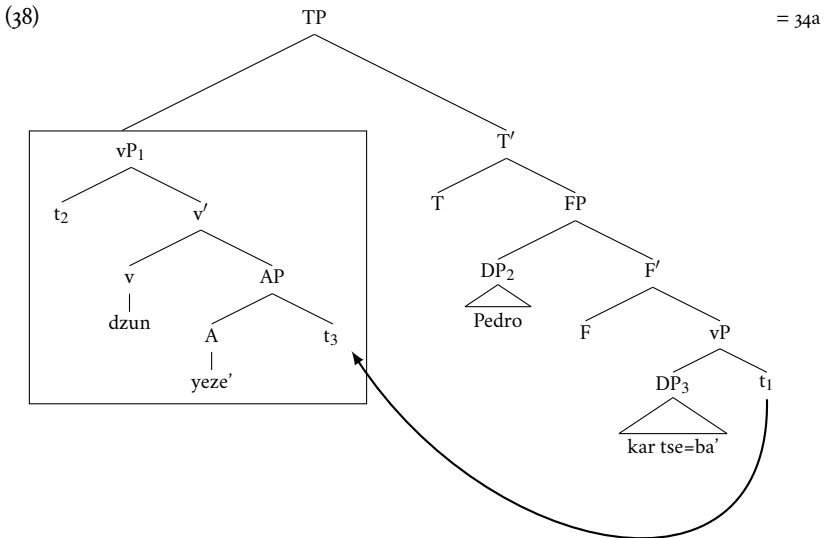

The nonverbal element always occurs immediately following the light verb, as it cannot move on its own.

- (39) a. ***Yeze'** dzun Pablo kar tse=ba'.
boastful do.CONT Pablo car of=3.HU
 Intended: 'Pablo is boasting about his car.'
 (FSR, SLZ1016, 0:30)

- b. * **Lazhe** dzon Pedro nada'.
lying do.CONT Pedro 1SG
 Intended: 'Pedro is lying to me.' (FA/RM, GZYZ019, 1:21:39)
- c. * **Tsgwa** dzon Pedro kar tse=ba'.
a.lot do.CONT Pedro car of=3.HU
 Intended: 'Pedro is showing off his car.' (FA/RM, GZYZ019, 1:21:19)

By contrast, under the verb raising account, there is no way to understand how the nonverbal element ends up between the light verb and subject. Unlike with copular clauses, movement of the nonverbal element on its own appears to be blocked. And even if it could move, doing so would violate the adjacency requirement in (15), as it would involve movement of the nonverbal element to a position between T and the subject in Spec-FP. This is a final argument in favor of the predicate raising account.

7 FUTURE PROSPECTS

Verb initiality in SLZ is derived, then, through predicate raising. This is perhaps somewhat more difficult to see than in Austronesian, where the object can sometimes surface inside the constituent that moves, yielding vos. If objects and other non-subject constituents obligatorily move because they are freely ordered amongst one another, then the evidence for predicate raising has to come from other elements with a more restricted distribution: some adverbs and some predicates.

So, not all languages with rigid vso word order use verb raising. While this correlation may not turn out to be crosslinguistically robust, adopting predicate raising for verb initiality in SLZ allows us to maintain other generalizations, including the fixed ordering of temporal and aspectual adverbs. And, it revealed another possible generalization—the adjacency requirement between the sentence-initial predicate and the subject—which we will hopefully gain a better understanding of through closer scrutiny of other verb-initial languages.

REFERENCES

- Anderson, Stephen R. & Sandra Chung. 1977. On grammatical relations and clause structure in verb-initial languages. In Peter Cole & Jerry M. Sadock (eds.), *Grammatical relations*, vol. 8 Syntax and Semantics, 1–25. New York: Academic Press.
- Black, Cheryl A. 2000. *Quiégolani Zapotec syntax: A principles and parameters account*. Arlington, TX: SIL International.
- Broadwell, George Aaron. 2004. The morphology of Zapotec pronominal clitics. In Rosemary Beam de Azcona & Mary Paster (eds.), *Conference on Otomanguean and Oaxacan languages*, vol. 14 Survey Reports, 15–36. Berkeley, CA: Survey of California and Other Indian Languages.

- Broadwell, George Aaron. 2005. It ain't necessarily S(V)O: Two kinds of VSO languages. *Proceedings of the LFG Conference*.
- Chomsky, Noam. 1970. Remarks on nominalization. In Roderick A. Jacobs & Peter S. Rosenbaum (eds.), *Readings in English Transformational Grammar*, 184–221. Waltham, MA: Ginn and Company.
- Chung, Sandra. 1990. VP's and verb movement in Chamorro. *Natural Language and Linguistic Theory* 8. 559–619.
- Cinque, Guglielmo. 1999. *Adverbs and functional heads: A crosslinguistic perspective*. Oxford: Oxford University Press.
- Clemens, Lauren Eby & Jessica Coon. To appear. Deriving verb-initial word order in Mayan. *Language*.
- Foley, Steven, Nick Kalivoda & Maziar Toosarvandani. To appear-a. Forbidden clitic clusters in Zapotec. *Chicago Linguistic Society (CLS)* 53.
- Foley, Steven, Nick Kalivoda & Maziar Toosarvandani. To appear-b. Gender-Case Constraints in Zapotec. *Workshop on Structure and Constituency in Languages of the Americas (WSCLA)* 22.
- Folli, Raffaella, Heidi Harley & Simin Karimi. 2005. Determinants of event type in Persian complex predicates. *Lingua* 115. 1365–1401.
- Foreman, John Olen. 2006. *The morphosyntax of subjects in Macuilianguis Zapotec*: University of California, Los Angeles dissertation.
- Grimshaw, Jane. 2005. Extended projection. In *Words and structures*, 1–73. Stanford, CA: CSLI.
- Haider, Hubert. 2006. Mittelfeld phenomena (Scrambling in Germanic). In Martin Everaert & Henk van Riemsdijk (eds.), *The Blackwell companion to syntax*, vol. 3, 204–274. Oxford: Blackwell.
- Holmer, Arthur. 2005. Seediq: Antisymmetry and final particles in a Formosan VOS language. In Andrew Carnie, Heidi Harley & Sheila Ann Dooley (eds.), *Verb first: On the syntax of verb-initial languages*, 175–201. Amsterdam: Benjamins.
- Kratzer, Angelika. 1996. Severing the external argument from its verb. In Johan Rooryck & Laurie Zaring (eds.), *Phrase structure and the lexicon*, 109–137. Dordrecht: Kluwer.
- Lee, Felicia. 2003. Anaphoric R-expressions as bound variables. *Syntax* 6(1). 84–114.
- Lee, Felicia. 2006. *Remnant raising and VSO clausal architecture: A case study of San Lucas Quiavini Zapotec*. Amsterdam: Springer.
- Long, Rebecca & Sofronio Cruz. 2000. *Diccionario Zapoteco de San Bartolomé Zoogocho Oaxaca*. Mexico City: Instituto Lingüístico de Verano.
- López Nicolás, Oscar. 2016. *Estudios de la fonología y gramática del zapoteco de Zochina*: Centro de Investigaciones y Estudios Superiores en Anthropología Social dissertation.
- Marlett, Stephen A. 1993. Zapotec pronoun classification. *International Journal of American Linguistics* 59(1). 82–101.
- Massam, Diane. 2001. Psueo noun incorporation in Niuean. *Natural Language and Linguistic Theory* 19. 153–197.

- Massam, Diane & Carolyn Smallwood. 1997. Essential features of predication in English and Niuean. *North East Linguistic Society (NELS)* 27. 263–272.
- McCloskey, James. 1991. Clause structure, ellipsis and proper government in Irish. *Lingua* 85. 259–302.
- McCloskey, James. 1996. On the scope of verb movement in Irish. *Natural Language and Linguistic Theory* 14. 47–104.
- McCloskey, James. 1997. Subjecthood and subject positions. In Liliane Haegeman (ed.), *Elements of grammar*, 197–235. Dordrecht: Kluwer.
- McCloskey, James. 2002. Resumption, successive cyclicity, and the locality of operations. In Samuel David Epstein & T. Daniel Seely (eds.), *Derivation and explanation in the Minimalist Program*, 184–226. Malden, MA: Blackwell.
- Otsuka, Yuko. 2000. *Ergativity in Tongan*: University of Oxford dissertation.
- Pensalfini, Robert. 1995. Malagasy phrase structure and the LCA. In Robert Pensalfini & Hiroyuki Ura (eds.), *Papers on Minimalist syntax*, vol. 27 MIT Working Papers in Linguistics, 245–260. Cambridge, MA: MITWPL.
- Sonnenschein, Aaron. 2004. *A descriptive grammar of San Bartolomé Zoogocho Zapotec*: University of Southern California dissertation.
- Stowell, Timothy. 1981. *Origins of phrase structure*: Massachusetts Institute of Technology dissertation.
- Tenny, Carol L. 2000. Core events and adverbial modification. In Carol L. Tenny & James Pustejovsky (eds.), *Events as grammatical objects*, 285–334. Stanford, CA: CSLI Publications.
- Toosarvandani, Maziar. 2017. On reaching agreement early (and late). In Jason Ostrove, Ruth Kramer & Joseph Sabbagh (eds.), *Asking the right questions: Essays in honor of Sandra Chung*, 124–138. Santa Cruz, CA: Department of Linguistics, University of California, Santa Cruz.

An Old Irish Story of a Woman Poet in Donegal

Liam Breatnach

Dublin Institute for Advanced Studies

In early medieval Ireland, from at least the eighth century, there is attested a great variety of texts relating to what a learned poet should know, such as metrical tracts, as well as status texts, which distinguish grades of poets according to their ability and learning.¹ These texts include formal studies of grammar and the nature of language, the best known of which is *Auraicept na nÉces* 'The Primer of the Poets', the earliest core of which is usually dated to the eighth century AD.² One text in particular, *Bretha Nemed Dédenach*,³ transcends all these categories, being a collection of material relating to the status of the poets as well as a most varied selection of discussions of specific aspects of poetry such as how to ask for rewards,⁴ the use of satire, metrics, how sounds and words are produced,⁵ and so on, and the title given to it by its first editor, E.J. Gwynn, 'An Old-Irish Tract on the Privileges and Responsibilities of Poets' is a fair enough description of its contents.⁶ We know from the second Middle Irish Metrical Tract that this text was on the curriculum of the poetic schools; the metrical tract is arranged in the form of twelve-year syllabus of study for the *fili* 'learned poet',⁷ and one of the items given in the syllabus for the fourth year is the study of *Bretha Nemed*.⁸ The text was edited by Gwynn (1942) with an introduction and notes, but without translation, and again by Binchy in *CIH* pp. 1111-32, with numerous cross-references. Quite a few passages have since been edited with translations and annotations, but the main obstacle to a complete edition and

¹These texts consistently distinguish between on the one hand, the *fili* (pl. *filid*), usually translated as 'poet' or 'learned poet', a person who has undergone a formal training not only in metrics, but also in grammar, history, genealogy, sagas, law, and specialised in all areas of secular learning (but not to the exclusion of ecclesiastical learning), and on the other hand, the lower-status *bard* (pl. *baird*), rendered into English as 'bard', a term which appears to cover every other kind of versifier, whether literate or not.

²The most recent edition is by Ahlqvist (1983).

³*Bretha Nemed* can be translated 'Judgements concerning Dignitaries'. There are two texts, which mainly concern the learned poets, which have this element in their titles, and they are distinguished/ by the addition of *toisech* 'first' in one, and *dédenach* 'last' in the other; see further Breatnach (2005, 184-91).

⁴See Corthals (2010).

⁵See Corthals (2007).

⁶He provides a more detailed account on pp. 3-6 of his edition.

⁷Ed. Thurneysen (1891, 29-66). See also Murphy (1961 v).

⁸Thurneysen (1891, 36 §18).

translation is the deliberately abstruse poetic language which characterises this text.⁹

In this paper I hope to make a further small contribution to the elucidation of this difficult text, by editing a short anecdote in *Bretha Nemed Dédenach* which consists of a prose account followed by a verse piece. Only one complete copy survives, in the seventeenth-century MS, Trinity College Dublin H 2. 15A, and it is printed in *CIH* 1126.7-20. In addition six extracts from this passage are cited in *O'Davoren's Glossary* (see below).

The verse is put into the mouth of a certain Eithne, and concerns her beloved Echaid, imprisoned on Tory Island as a result of an uprising by the servile peoples of Ulster, over whom he had been appointed as deputy ruler by the king of Ireland. Two of the names in this anecdote are well-known, viz. Cormac aue Cuinn, a (probably legendary) pre-Christian king of Tara (and thus of Ireland), and Fercheirtne, a mythical pre-Christian poet. On the other hand, I have come across no other mention of Eithne daughter of Amalgaid in the extensive remains of Early Irish literature. Although the same is the case for Echaid Búadach, his father, Fergus Duibdétach, is not only frequently mentioned as a (probably legendary) pre-Christian king from the Ulaid 'Ulstermen', who became king of Ireland, but he is closely connected with Cormac in that he is represented as his immediate predecessor, and as having been killed by Cormac in the battle of Crinna.¹⁰ The only well-known population group mentioned is the Ulaid 'Ulstermen', and the two placenames, Tara and Tory Island, are also well-known; it is the latter which makes the connection with County Donegal.

References to Tory, an island seven and a half miles off the coast of County Donegal, in pre-Norman sources are few. In the Annals of Ulster for the year 617 there is a recorded a sacking of the island,¹¹ which is dated in another set of annals, the Annals of the Four Masters, to the year 612, and the latter annals also mention the rebuilding of the church in the year 616.¹² There is an interesting tale in *Immram Curaig Maile Dúin* 'The Voyage of Máel Dúin's Boat', in my view one of the best prose works of the Old Irish period, about the *coic* 'cook' of the church of Tory, who, as the person in charge of the food supply, corruptly enriched himself by selling the food intended for the members of the church.¹³ The short anecdote presented here is, then, of all the more interest because of the geographical setting of the story. The principal archaeological remains are those of a promontory fort and of an early medieval church foundation, including a Round Tower, and given that the temporal setting of the anecdote is in

⁹To the list in Breatnach (2005, 185) can be added the edition and translation of the sections of the text comprising *CIH* 111.19-22 in Breatnach (2004, 26-7), of *CIH* 114.13-6 in Breatnach (2006, 67-8), of *CIH* 1125.24-7 in Breatnach (2004, 29-30), of *CIH* 1126.33-1129.32 in Corthals (2007), and of *CIH* 1129.33-1130.37 in Corthals (2010).

¹⁰Cf., for example, in the pre-Norman genealogies, *Fergus Dubdétach mac Fíndchada uno anno rí hèreinn co torchair i cath Chrinna la Cormac húa Cuinn* 'Fergus Dubdétach son of Findchad was king of Ireland for one year, until he fell in the battle of Crinna at the hands of Cormac aue Cuinn', O'Brien (1962, 121).

¹¹Ed. Mac Airt and Mac Niocaill (1983)

¹²Ed. O'Donovan (1856).

¹³Oskamp (1970, 168-9 §33).

the pre-Christian period, the promontory fort is probably the imagined place of detention of Echaid.

The prose introduction has the look of a set of background notes, while *riam* at the end implies that she followed her rhetoric with an explanation of its import. We are not, however, told what ensued. The rhetoric itself brings us to one of the major outstanding issues in our understanding of early Irish metrics. While the greater part of Medieval and Early Modern Irish verse, from the eighth century to the seventeenth, is stanzaic, with regular syllable count and end-rhyme, we also have, especially in the Old Irish period, verse compositions of a different structure, the most notable feature being absence of rhyme. The question which still awaits an answer is what exactly the intended metrical structure of compositions such as that edited here was. In our case, we can at least determine that it is not prose, not only as it is described as a *dichetal* 'chant', but as it is marked by features of poetic language such as alliteration, hyperbaton,¹⁴ asyndeton and prepositionless datives,¹⁵ as well as by the three antithetical lines with which it begins. It goes without saying that only with editing and translating more of these texts can we expect to come to some deeper understanding of their metrical structure.

Although the great majority of the documented poets of the pre-Norman period in Ireland were male, there is some evidence for female poets as well, perhaps the most unambiguous being the Uallach whose death is noted in the Annals of Inisfallen under the year 934 as *Quies Uallaige ingene Muinechain, banfile Herend* 'Repose of Uallach daughter of Muinechán, poetess of Ireland'.¹⁶ The very fact that she is mentioned in the annals at all indicates that she must have been particularly highly regarded as a learned poet. It seems to me that the contemporary relevance (to eighth- and ninth-century Ireland) of this anecdote, which is set in the prehistoric past,¹⁷ is on the one hand to stress the difficulties facing any woman who might wish to qualify as a learned poet,¹⁸ and on the other, to acknowledge that women could indeed be up to the task, by representing a competent piece of poetry as having been composed by a woman. It is reasonable to assume that the compositions put into the mouths of fictional characters in a work such as *Bretha Nemed Dédenach*, a text which was on the curriculum of the *fili*, are also intended to serve as models of composition.

As is the case with many other texts composed in the pre-Norman period, the earliest surviving manuscript is much later than the date of composition, and although the manuscript of this text is particularly late a number of diagnostic Old Irish linguistic features leave us in no doubt that the text was composed in the Old Irish period. Some of these are: the nasalising relative clause in *do-*

¹⁴Such as the tmesis and proposed genitive in *ro fine tonn tethraig*, where in prose one would expect *ro tethraig tonn fine*.

¹⁵As in *glasaib slabradaib*, which in prose would be expressed as *i nglasai ocus i slabradaib*.

¹⁶Mac Airt (1951, 150-1). See also Clancy (1996).

¹⁷The date of composition may well be in the eighth century, but is certainly no later than the ninth.

¹⁸In this regard, the statement that Eithne went *do fogloim éicsi* 'to study poetic learning' marks her out as a high-ranking *fili*, rather than a *bard* (see above).

mber, the deuterotonic verbal form with infixed pronoun *Ara-ngabat-sidi*, the infixed pronoun in *na mberat*, the *s*-subjunctive (3sg. past) form of *as-indet* in *as-indised*, the suppletive perfective form of *ad-fét* in *ad-cuaid*, and the reduplicated preterites *cachain* (to *canaid*) and *tethraig* (to *traigid*). The text presented here is normalised to an Old Irish standard, with the MS text following the translation. The only emendations (as opposed to replacing later orthography with that of OIr) are dpl. *cineluibh si* to *apl. cenéla-sa*, *gpl. mbliadhan* to *mbliadnae*, *asperattar* to *as-bertatar*, *mionn oir* to *mind n-óir* (similarly *minn oir* in O'Dav. 1563, with omission of nasalisation after *-nn*), and (the most serious one) *eneclann credidh* to *enech ruided*.¹⁹

I am offering this small piece, set in a county which has always been close to Jim's heart, in recognition of Jim's other academic side, his interest in Old and Middle Irish, in memory of our years spent together as undergraduates studying in UCD with Conn Ó Cléirigh and Proinsias Mac Cana, and as a token of our friendship ever since.

1 TEXT AND TRANSLATION

Echaid Búadach mac Fergusa Duibdétaig do-mbert Cormac aue Cuinn forsna cenéla-sa uili .i. Laimne, Laigne, Luigne, Artraige, Daimne, Maigne ⁊ mugraige Ulad uile. Ara-ngabat-sidi ⁊ na mberat i Toraig ⁊ as-bertatar ba marb. Ocus do-gníthe feis Temrach la Cormac dia téora mbliadnae.

Eithne ingen Amalgaid maic Muiredaig, carad-side Echaid ⁊ ro-fitir a airgabáil ⁊ at-chobair as-indised i Temair ⁊ ní ticed nech cen dán i Temair. Luid Eithne do fogloim éicsi la Fercheirtne i richt gillai ⁊ ad-cuaid a scél i Temair ⁊ cachain díchetal riam:

*Fo-rruined grían, genither dorcha,
ro hór mas múchad, ro mórad mugraige,
ro fine tonn tethraig, ro linsat lathcha lóchlada.*

*Ro cléithi inse Érenn enech ruided,
do-coisig Torach mind n-óir flaitheaman fer nGoidel,
ro gennad glasaib slabradaib, suidigther forbaid fois
– Echaid Búadach mac Fergusa Duibdétaig.*

Echaid Búadach son of Fergus Dubdétach, whom Cormac grandson of Conn set over all of these peoples, i.e. the Laimne, Laigne, Luigne, Artraige, Daimne, Maigne and all servile peoples of the Ulstermen. They take him prisoner and bring him to Tory Island and said that he died. Now the feast of Tara used to be

¹⁹As it is impossible to make any sense of the MS reading, some emendation is necessary; in any case the first word is not written out in full, but as *enecl* followed by a suspension-stroke (admittedly the usual abbreviation for *eneclann*).

held by Cormac every third year.

Eithne the daughter of Amalgaid son of Muiredach, she loved Echaid, and she discovered that he had been taken captive, and she wished to make it known in Tara, yet no one without an art used to come into Tara. Eithne, disguised as a boy, went to study poetic learning with Ferchertne, and was able to tell her story in Tara, and sang a chant before [doing so]:

The sun has sunk, darkness is arising,
fine gold has been suppressed, servile peoples have been magnified,
the cresting wave²⁰ of the kin has ebbed, puddles and dark marshes²¹ have flooded up.

The face of the pre-eminent one of the island of Ireland has been reddened,²²
Tory is securing the golden diadem of the lord of the men of the Irish,²³
who has been firmly fixed in fetters and chains,²⁴ who is placed in the raiment of immobility²⁵

– Echaid Búadach son of Fergus Dubdétach.

2 TRANSCRIPT OF MANUSCRIPT TEXT

Eochaidh búadhach mac Fergusa duibhdhédoigh dombert Cormac Ua Cuinn forsna cineluibh si uile .i. Laimne, Laighne, Luighne, Artraighe, Daimhne, Maighne. ⁊ Mughraighe Uladh uile; ara ngabhadsaidhe, ⁊ nom-berad i dToraigh, ⁊ asperattar ba marbh; ⁊ do gniithe feis Temhrach la Cormac dia theora mbliadhan. Eithne inghen Amhalgaidh meic Muireadhoigh caradsaidhe Eochaidh ⁊ rofidir a urghabhail, ⁊ adchobair as innisiodh i dTemhair, ⁊ ní thigedh nech gan dan i dTemhair. Luidh Eithne do foghloim eigsi la Firchirtne i riocht giolla, ⁊ ad-cuaidh a sgel i dTemhair ⁊ cachain diche dol riamh. For-ruinedh grian. genither dorcha ro hór mas muchadh. ro mórad Mughraighe. ro fine tonn tethraigh. ro lionsad lathcha lóchlada. ro cléithe innsi Éreann. eneclann credidh do coisig Toraigh, mionn oir flaithemhan fer nGaoidhiol ro gennadh glasaibh slabhradhoibh, suidhighther forbaidh fois. Eochaidh buadhach mac Fergusa duibhdhédoigh, CIH 1126.7.

There are six citations in *O'Davoren's Glossary*, namely (following the order of the text above), 223 (CIH 1474.27), 26 (CIH 1467.4), 1230 (CIH 1515.20), 1562

²⁰A play on the two meanings of *tonn*, 'wave' and 'top'.

²¹Taking *lóchlada* as npl. of a compound of *lóch* and *loth*.

²²An offence against a person's honour is usually described in Old Irish sources in terms of reddening (or causing to blush) a person's face, or cheeks. In this case, the attack on and imprisonment of his deputy Echaid is also an attack on the honour of Cormac, king of Ireland. Our text thus adverts to an important principle of the early medieval Irish legal system, for which see Breatnach (2013, 5-9).

²³That is, Echaid is represented as the 'golden diadem' of Cormac.

²⁴A different interpretation is offered in Hull (1949, 134).

²⁵That is, he is 'clothed' in fetters and chains so that he cannot move freely. For the distinction between *glas*, a shackle for the feet, and *slabrad*, a chain round the neck, see Binchy (1962, 71-2).

(*CIH* 1529.25), 1563 (*CIH* 1529.27), and 1064 (*CIH* 1508.16).²⁶ There are only four significant variant readings; one of these, *tocoisigh Torach* in 1563 is superior to *do coisig Toraigh*, and the others are *machaidh* (*machad*, F) in 1230, against *muchadh*, *teachrac* (*tethrach*, F) in 1562, against *tethraigh*, and *gemad* in 1064, against *gennadh*.

REFERENCES

- CIH* = Binchy, D. A. (1978): *Corpus Iuris Hibernici* (Dublin).
- Ahlqvist, Anders (1983): *The Early Irish Linguist. An Edition of the Canonical Part of the Auraicept na nÉces, with Introduction, Commentary and Indices.* Societas Scientiarum Fennica, *Commentationes Humanarum Litterarum* 73 (Helsinki).
- Binchy, D. A. (1962): 'The Old-Irish Table of Penitential Commutations', *Ériu* 19, 47-72.
- Breatnach, Liam (2004): 'On Satire and the Poet's Circuit', in Cathal G. Ó Háinle and Donald Meek (eds), *Unity in Diversity. Studies in Irish and Scottish Gaelic Language, Literature and History* (Dublin) 25-35.
- Breatnach, Liam (2005): *A Companion to the Corpus Iuris Hibernici.* Early Irish Law Series 5 (Dublin).
- Breatnach, Liam (2006): 'Satire, Praise and the Early Irish Poet', *Ériu* 56, 63-84.
- Breatnach, Liam (2013), 'The Lord's Share in the Profits of Justice and a Passage in Cath Maige Tuired', *Celtica* 27, 1-17.
- Clancy, Thomas Owen (1996): 'Women Poets in Early Medieval Ireland: Stating the Case' in Christine Meek and Katherine Simms (eds) 'The Fragility of her Sex?': *Medieval Irish Women in their European Context* (Dublin) 43-72.
- Corthals, Johan (2007): 'Stimme, Atem und Dichtung: Aus einem altirischen Lehrbuch für die Dichterschüler (Uraicept na Mac Sésa)', in Helmut Birkhan (ed.) *Kelten-Einfälle an der Donau. Akten des Vierten Symposiums deutschsprachiger Keltologinnen und Keltologen* (Wien) 127-47.
- Corthals, Johan (2010): 'The Áiliu Poems in Bretha Nemed Dédenach', *Éigse* 37, 59-91.
- Gwynn, E. J. (1942): 'An Old-Irish Tract on the Privileges and Responsibilities of Poets', *Ériu* 13, 1-60; 220-36.
- Hull, Vernam (1949): 'Miscellanea Linguistica Hibernica', *Language* 25, 130-8.
- Mac Airt, Seán (1951): *The Annals of Inisfallen* (Dublin).
- Mac Airt, Seán and Mac Niocaill, Gearóid (1983): *The Annals of Ulster (to A.D. 1131)* (Dublin).
- Murphy, Gerard (1961): *Early Irish Metrics* (Dublin).
- O'Brien, M. A. (1962): *Corpus Genealogiarum Hiberniae* 1 (Dublin).
- O'Donovan, John (1856): *Annala Rioghachta Éireann. Annals of the Kingdom of Ireland by the Four Masters, from the Earliest Period to the Year 1616* (Dublin).

²⁶References are to the paragraph numbers of the edition by Whitley Stokes (1904), with the relevant page and line number of the edition in *CIH* 1466.11-1531.24 in parentheses. For an account of *O'Davoren's Glossary* see Breatnach (2005, 100-59).

- Oskamp, Hans P. A. (1970): *The Voyage of Máel Dúin. A Study in Early Irish Voyage Literature* (Groningen).
- Stokes, Whitley (1904): 'O'Davoren's Glossary', *Archiv für celtische Lexikographie* 2, 197-504.
- Thurneysen, Rudolf (1891): 'Mittelirische Verslehren', *Irische Texte* 3, 1. Heft (Leipzig) 1-182.

Maximize Presupposition and Types of Indefinites in Chamorro^{*}

Sandra Chung
University of California, Santa Cruz

1 INTRODUCTION

It is by now widely accepted that natural language allows a range of types of indefinites. For instance, some types of indefinites are scopally unrestricted; others must have wide scope with respect to semantic operators; still others must have narrowest scope, or must be within the scope of an operator in order to occur at all (see e.g. Matthewson 1999 on St'át'imcets). Within semantic theory, particular attention has been devoted to the types of indefinites that must have narrowest scope (henceforth narrow-scope indefinites). Chung and Ladusaw (2004 and 2006; henceforth C&L) account for such indefinites by enriching the inventory of semantic composition operations that combine predicates with their arguments. Specifically, they propose that a predicate can be combined with the descriptive content of an indefinite by Restrict, a composition operation that does not saturate the targeted relatum of the predicate but merely narrows its domain. C&L make no attempt to connect the limited scope potential of such indefinites to other aspects of their semantic-pragmatic profile. However, languages such as Hungarian, Spanish, and Catalan have bare singular NPs that must have narrowest scope, are semantically number-neutral, and make no contribution to discourse dynamics. This constellation of properties has led Farkas and de Swart (2003) and Espinal and McNally (2009) to propose accounts in which these deficiencies in scope, number, and discourse contribution are intertwined. The accounts are inspired by the leading idea—traceable to Van Geenhoven's (1998) seminal work on semantic incorporation—that narrow-scope indefinites are more

^{*}All love to Jim, to whom I dedicate this paper, in recognition of many years of intellectual engagement and companionship. Many thanks to the Chamorro speakers who contributed to this work, especially Manuel F. Borja, Dr. Elizabeth D. Rechebei, Tita A. Hocog, the late Dr. Rita H. Inos, the late Maria P. Mafnas, Maria T. Quinata, Francisco Tomokane, the late Anicia Q. Tomokane, and the members of the Chamorro Dictionary Revision Project. Thanks also to Michela Ippolito, who pointed out to me some years ago the relevance of sentences like (30a) for MP. I am indebted to Louise McNally, Chris Barker, and Deniz Rudin for detailed, insightful commentary, and to Pranav Anand for brief, perceptive remarks; their comments led me to significantly reconfigure an earlier draft. The research reported here was supported in part by NSF project BCS-0753240 to the University of California, Santa Cruz.

limited than other types of indefinites *along multiple dimensions*.

It is worth asking whether narrow-scope indefinites have this deficient character across languages. Here I offer some novel evidence that suggests that they do not. The evidence comes from Chamorro, an Austronesian language of the Mariana Islands.

Alongside the definite article *i*, Chamorro has two indefinite articles that differ in scope possibilities. One indefinite article, *un*, has roughly the same range of scope options as English *a*. The other indefinite article, which is unpronounced, must have narrowest scope. Although I contend that indefinites formed from the null indefinite article are DPs, they have a realization indistinguishable from bare NPs. That might lead one to wonder to what extent they fit the profile of narrow-scope indefinites in Hungarian, Spanish, or Catalan.

I first show that Chamorro indefinites formed from the null indefinite article have semantic number and set up discourse referents that can be referred to subsequently. In these respects, they appear no more limited than indefinites formed from *un*. The rest of the discussion documents a pragmatic dimension along which the null indefinite article has a *less* limited distribution than *un*. This dimension involves Maximize Presupposition (MP), the pragmatic principle that urges the speaker to ‘Make your contribution presuppose as much as possible!’ (Heim 1991: 514-515).¹ Heim originally postulated MP to account for two effects, which have been called *antipresupposition* (following Percus 2006) and *presuppositional implicature* (following Leahy 2016). The indefinite article *un* exhibits both effects. But, surprisingly, the null indefinite article exhibits the second effect, but not the first.

There is no consensus on the precise formulation of MP, whether it can be made to follow from Grice’s maxims, or even whether the effects attributed to it should be explained by the same principle (see e.g. Percus 2006, Singh 2011, Schlenker 2012, Leahy 2016, and Lauer 2016 for a range of views). However, many discussions of MP are framed partly in terms of presuppositional scales. Pairs of lexical items that “differ minimally” (Lauer 2016: 980) in carrying, or not carrying, a particular presupposition are viewed as arranged in a scale ordered by presuppositional strength. MP directs speakers to choose the alternative that employs the strong rather than the weak member of the scale—the alternative that presupposes more—if they can.

In Chamorro, the definite article carries a uniqueness presupposition that the indefinite articles lack. So we expect these articles to form a presuppositional scale in which the definite article is strong and the indefinite articles are weak; this is what happens for presuppositional implicature.² Why is the null indefinite article ignored for antipresupposition? I suggest that part of the answer lies in C&L’s notion of mode of composition. From the perspective of semantic composition, the definite article and *un* are what Horn and Abbott (2014: 334) would call “natural paradigmatic alternatives”: they are type-shifters that enable the de-

¹In the original: “Präsupponiere in deinem Beitrag so viel wie möglich!” (Heim 1991: 515).

²Cf. Hawkins (1991: 426) and Horn and Abbott (2014), who propose that the *and* and *a* form a scale for the purposes of scalar implicature.

scriptive content of DP to be composed with the predicate via Function Application. In contrast, the null indefinite article signals that the descriptive content of DP should be composed directly with the predicate via Restrict. This, I claim, is enough to explain why the null indefinite article does not compete with the definite article for antipresupposition purposes.

Like C&L, Farkas and de Swart (2003) and Espinal and McNally (2009) claim that the descriptive content of a narrow-scope indefinite is composed directly, as a property, with the predicate. This means that as far as antipresupposition is concerned, their accounts could make the same cut among Chamorro's three articles as C&L. But to the extent that these other accounts are designed to deliver narrow scope together with number neutrality and discourse inertia, they are not well-suited to handle the null indefinite article's full profile. For this reason, I maintain, C&L's approach is more appropriate here.

Section 2 introduces Chamorro and the three articles that are the focus of investigation. Section 3 sketches some ways of accounting for definites and indefinites in this language. It also presents evidence that the limited scope potential of the null indefinite article is not correlated with number neutrality or discourse inertia. Then, section 4 introduces MP and the effects attributed to it. Section 5 shows that the indefinite articles behave as expected for presuppositional implicature: in contexts in which the definite article's uniqueness presupposition is not already known to be satisfied, use of an indefinite article conveys that the speaker believes that the extra information that the definite article would have communicated is false.³ Sections 6 and 7 deal with antipresupposition. Section 6 zeroes in on the use of articles in possessives. Chamorro possessives differ from English possessives like *Meg's cat* in that the article and the possessor co-occur and co-vary freely. I first confirm that Chamorro possessives formed from the null indefinite article have the form and meaning of indefinites, even when their possessor is definite. I then show that for possessed nouns for which it is common knowledge that the possessee is unique relative to the possessor (e.g. *gui'ing* 'nose', *nâna* 'mother'), the two indefinite articles pull apart: *un* displays antipresupposition effects—its use is infelicitous—but the null indefinite article can be used felicitously. Section 7 uncovers a similar pattern in the use of articles with nouns whose intended referent is commonly understood to be unique in the real world (e.g. *âtdao* 'sun'). After suggesting an account of these patterns, section 8 concludes with some general remarks about the typology of narrow-scope indefinites and its connection to the semantics of noun incorporation.

2 CHAMORRO: THE BASICS

Chamorro is spoken by some 35,000-40,000 people in the U.S. Commonwealth of the Northern Mariana Islands (CNMI) and the unincorporated U.S. territory

³The wording here closely tracks Leahy (2016: 89). Alternatively, in wording closer to Heim's (1991: 516), the proposition expressed by the corresponding sentence with the definite article is false (or not known by the speaker to be true).

of Guam, and by numerous Chamorros in the continental U.S. The language has undergone rapid decline in the last half-century, and is now widely believed to be on the cusp of endangerment.

The language is head-initial and allows a range of null arguments. Clauses consist of a predicate, which can be a verb, noun, adjective or preposition, followed by the predicate's arguments and adjuncts. When the predicate is a verb or adjective, the relative order of arguments and adjuncts is flexible, but the unmarked, most frequent word order is: *Verb/Adjective Subject Object Other* (see Chung 1998). The inflected verbs are underlined in (1).⁴

- (1) Ha konni' si Orasima' i haggan, ya ha po'lu gi buti-ña.
AGR take UNM Orasima' the turtle and AGR put LOC boat-AGR
 'Orasima' took the turtle, and he put it in his boat.' (from a narrative)

DPs formed from common nouns consist of a determiner (D) followed by an NP constituent consisting of the noun, its complements, and modifiers. The noun (underlined in (2)) precedes its complements, but can be preceded or followed by modifiers.

- (2) i ottimu na istoria ni guaha ta'lu sustansián-ña
the last L story COMP AGR.exist again substance-AGR
 'the last story which again has substance' (EM 99)

The Ds include quantifiers, demonstratives, and three articles: the definite article *i*, the indefinite article *un*, and the null indefinite article.

At first blush, the three articles have uses broadly similar to the uses of the definite and indefinite articles in English. The definite article *i* is used when the speaker and hearer can uniquely identify the intended referent of DP. In (3a), for instance, *i* is used because there is a unique sun in the world. In (3b), from a story, the old woman is the only individual who has been previously mentioned who is both female and old. In (3c)—an instruction from a psycholinguistic experiment involving a computer tablet—there is only one star displayed on the tablet screen. Finally, in (3d), it is reasonable to infer that the engine is unique relative to the car under discussion. (The relevant DPs are underlined.)

- (3) a. Dokku' i atdao.
AGR.sprout the sun
 'The sun rose.'

⁴The Chamorro examples are cited in the official orthography now used in the CNMI. In this orthography, possessor agreement is separated from the rest of the word by a hyphen. The words otherwise have not been explicitly decomposed into morphemes. The glosses employ the following abbreviations: AGR = agreement, AP = antipassive, COMP = complementizer, EMP = emphatic, FUT = future, INFIN = infinitive, L = linker, LOC = local case, OBL = oblique case, PASS = passive, PL = plural, PROG = progressive, Q = question, UNM = unmarked case, WH = wh-agreement. Naturally-occurring examples are taken from: Borja et al. 2006 (EM; a book of stories, essays, and poetry), Cooreman 1982 and 1983 (transcriptions of tape-recorded narratives), Marciano n.d. (a children's book), the database for the *Revised Chamorro-English Dictionary* (CD; illustrative examples created by community members for dictionary entries), and the Chamorro New Testament (NT; translated into Chamorro by a group led by Bishop Tomas A. Camacho). Examples not attributed to a source are from my fieldwork.

- b. Nina'gogof maguf i biha kumu guaha bisitã-ña.
AGR.pass.make.very happy.PROG the old.Lady if AGR.exist visitor-AGR
 'The old woman was made very happy when she had visitors.' (Marciano n.d.: 1)
- c. Chonnik i puti'un guatu gi ...
push the star to.there LOC
 'Push the star over to ... [the picture that fits the description].'
- d. Ti siña masugun i kareta sa' mayulang i makina.
not can AGR.pass.drive the car because AGR.PASS.break the engine
 'The car can't be driven, because the engine is broken.'

Following Roberts (2003), I assume that *i* carries both an existence presupposition and a presupposition of *informational uniqueness*—"the requirement that sufficient information has been given to uniquely indicate the intended discourse referent antecedent among all those in the common ground of the participants" (Roberts 2003: 307).

The indefinite articles have existential force. DPs formed from *un* or the null indefinite article are used to introduce new discourse referents, as in (4).

- (4) a. Mimilalak ginin i kannat un balutan magâgu.
AGR.float.PROG from the channel a bundle.L clothes
 'A bundle of clothes came floating from the channel.' (Cooreman 1983: 107)
- b. Anai ma baba, humuyung pâtgun.
when AGR open AGR.come.out child
 'When they opened it, a child came out.' (Cooreman 1983: 107)

DPs formed from either indefinite article display quantificational variability. The most natural interpretation of (5a) is that each child received a different bunch of bananas, and of (5b), that each house should have a different exit.

- (5) a. Ha dispâtta si nãna i rasimun aga' ya ha pâtti kada
AGR separate UNM mother the stalk.L banana and AGR apportion each
patgon-ña un iting.
child-AGR a bunch
 'Mother divided the banana stalk and gave each child of hers a bunch.'
 (CD, entry for *dispâtta*)
- b. Gi kada guma' debi di u guaha sagan fanhuyungan.
LOC each house should AGR exist place.L exit
 'In every house there has to be an exit.' (CD, entry for *fanhuyungan*)

Again following Roberts (2003), I assume that the fundamental difference between *i* and the indefinite articles is that *i* carries a uniqueness presupposition, but the indefinite articles do not.

The rest of the discussion takes it for granted that Chamorro has a three-way article system that includes two indefinite articles, one of which is not pronounced. Before going further, I should perhaps reiterate the claim that the null indefinite article exists as a D in its own right, as opposed to being an unpronounced form of one of the other articles or simply not instantiating a syntactic category at all. (In the latter scenario, what I have been calling ‘DPs formed from the null indefinite article’ would be bare NPs.) Some evidence supporting this claim will emerge in section 5. A selection of other evidence is offered below:

(i) Out of context, DPs formed from *un* or the null indefinite article can serve as the pivot of an affirmative existential sentence, but DPs formed from *i* cannot (see Chung 2006). This familiar pattern reveals the null indefinite article is not a phonologically reduced form of *i*.

- (6) a. Guaha un kostat suni.
AGR.exist a bag.L taro
 ‘There’s a bag of taro.’ (heard at a conference)
- b. Disdi esti, kada sákkán guaha nobena yan lukao.
since this each year AGR.exist novena and procession
 ‘Since this, every year there is a novena and procession.’ (EM 104)
- c. *Guaha i katni.
AGR.exist the meat
 (There’s the meat.)

(ii) DPs formed from *un* typically have wide scope with respect to negation (C&L 2004: 100-102), but DPs formed from the null indefinite article always have narrowest scope. Moreover, only DPs formed from the null indefinite article can be the pivot of a negative existential sentence. This pattern, shown in (7a), reveals that the null indefinite article is not a phonologically reduced form of *un*. (In addition, (7b) shows that out of context, the pivot of a negative existential sentence cannot be a DP formed from *i*.)

- (7) a. Tãya’ (*un) prublema.
AGR.not.exist a problem
 ‘There’s no problem.’
- b. Tãya’ (*i) sumásaga Susupe na paláo’an.
AGR.not.exist the AGR.Live.PROG Susupe L woman
 ‘There isn’t any/*the woman who lives in Susupe.’

(iii) Chamorro has a syntactic topic position at the left edge of the clause (Chung 1998). DPs formed from *i* or *un* can occupy this position, but DPs formed from the null indefinite article cannot. This is another reason for distinguishing the null indefinite article from the other two articles.

- (8) a. I taotao ha oddu' i balutan magâgu gi ilu-ña.
the person AGR carry the bundle.L clothes LOC head-AGR
 'The man carried the bundle of clothes on his head.' (CD, entry for *oddu'*)
- b. Parehu yan i simiyan mustâsa ni un tâotao ha chuli' ...
AGR.similar with the seed.L mustard comp a person AGR take
 'It is like a mustard seed, which a man took....' (NT 133)
- c. * Tâotao gai patgun un lâhi.
person AGR.have child a boy
 (A man had a son.)

(iv) Finally, like other DPs, indefinites formed from the null indefinite article can have a possessor (see section 6). Possessors in Chamorro occur high in the structure of DP, outside the NP constituent consisting of the noun, its complements, and modifiers. This is why noun incorporation, which incorporates NPs in Chamorro (see (9a)), cannot incorporate an NP accompanied by a possessor (see (9b-c) and C&L 2004: 85-88).

- (9) a. Gai [kareta ni agaga] si Juan.
AGR.have car COMP AGR.red UNM Juan
 'Juan has a car that is red.'
- b. * Gai [lepblom-mu] yu'.
AGR.have book-AGR I
 (I have your book.)
- c. * Hâyi gai [karetan Dolores]?
who? AGR.have car.L Dolores
 (Who has Dolores' car?)

The fact that indefinites of the type shown in (4b), (5b), (6b), and (7) can host a possessor reveals that they are constituents larger than NP. More precisely, they are DPs formed from a D that is not pronounced—the D referred to here as the null indefinite article.

3 SOME WAYS FOR ACCOUNTING FOR DEFINITES AND INDEFINITES IN CHAMORRO

I observed earlier that DPs formed from the null indefinite article must have narrowest scope. The three accounts of narrow-scope indefinites sketched below are similar in claiming that the descriptive content of such indefinites is composed directly with the predicate.

C&L claim that the descriptive content of narrow-scope indefinites is composed with the predicate by Restrict, a non-saturating operation that uses the

descriptive content of the indefinite to narrow the domain of the predicate's relatum. For Chamorro, this amounts to saying that the null determiner is a semantically vacuous identity element that composes with the meaning of NP to yield a DP that denotes a property. Restrict then applies to compose this property directly with the predicate's relatum. The analysis subtree in (10) illustrates how Restrict combines the meaning of the property-denoting DP *pátgun* 'child' with the meaning of the predicate *humuyung* 'come out, emerge' in the semantic composition of (4b). (I assume the predicate relation supplied by the verb includes a Davidsonian event argument.)

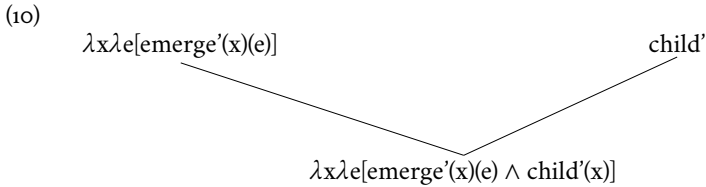

Note that the resulting expression is just as semantically incomplete as it was before Restrict applied: the value of the targeted relatum has not yet been fixed. C&L (2004: 11-12) assume that if the targeted relatum is not saturated by further predicate-argument composition, the incompleteness is remedied by existential closure, which occurs early enough in the compositional process to ensure narrowest scope.

Farkas and de Swart (2003) develop an approach to semantic incorporation that links the narrow scope of bare NPs to number neutrality and the failure to contribute a discourse referent. In their account, which is framed in Discourse Representation Theory, a predicate's thematic arguments normally combine with the meaning of argument nominals by instantiation: the predicate's thematic argument is replaced by the discourse referent that the argument nominal introduces. However, only nominals that are specified for semantic number can introduce discourse referents. When the argument nominal introduces no discourse referent, its descriptive content is unified with the predicate's thematic argument, forming a complex predicate; this is what gives rise to narrowest scope.

Finally, Espinal and McNally (2009) construct an account of bare noun objects in Spanish and Catalan that treats them semantically as verb modifiers. In their account, a lexical rule suppresses the verb's internal argument, thereby ensuring that this argument contributes no discourse referent. The lexical rule does not, however, block the entailment that two participants are involved in the event. Verbs whose internal argument has been suppressed are composed with the descriptive content of a bare noun complement by a special rule of intersective modification. The fact that the descriptive content of the bare noun combines directly with the verb meaning ensures that it has narrowest scope.

Despite certain recurring themes, there are substantial differences among these accounts. I want to focus here on the claim that certain types of indefinites—or, perhaps, bare NPs in general—are simultaneously deficient in scope,

number, and discourse dynamics. Is this the profile of narrow-scope indefinites (or bare NPs) crosslinguistically?

Chamorro's narrow-scope indefinites can be viewed as bare NPs, so the question can be raised about them. As a matter of fact, these indefinites do not appear to be deficient in number or discourse contribution. In these respects, they resemble indefinites formed from *un*.

To begin with, indefinites formed from the null indefinite article are not semantically number-neutral, although it requires a bit of effort to see this. The vast majority of Chamorro nouns show number inflection only optionally. However, the language has six nouns that must be inflected (irregularly) for number: *lâhi* 'man', *palâo'an* 'woman', *pâtgun* 'child', *saina* 'parent', *che'lu* 'sibling', and *pâli* 'priest'. Indefinites formed by combining these nouns with the null indefinite article are construed as singular if the noun is in the unmarked form, and as plural if the noun is in the plural form; they do not have a number-neutral interpretation.⁵

- (11) a. Manli'i' yu' pâtgun gi kantun tâsi.
 AGR.AP.see I child LOC edge.L ocean
 'I saw a child at the beach [= one child, not not more than one child].'
 b. Manli'i' yu' famagu'un gi kantun tâsi.
 AGR.AP.see I children LOC edge.L ocean
 'I saw children at the beach [= several children, not just one child].'

Further, indefinites formed from the null indefinite article can set up discourse referents that can be referred to subsequently, just like indefinites formed from *un*. This can be seen from the examples in (12), which are taken from narratives. In (12a), an indefinite formed from *un* serves as the antecedent of a definite DP later in the discourse (cf. (4a)); in (12b), an indefinite formed from the null indefinite article serves as the antecedent of a DP formed from a demonstrative (cf. (4b)); and in (12c), an indefinite formed from the null indefinite article serves as the antecedent of two (null) pronouns—the object of the transitive verb *gu'ut* 'grasp' and the subject of *malingu* 'disappear'.

- (12) a. Mimilalak ginin i kannat un balutan magâgu ... Pues ha
 AGR.float.PROG from the channel a bundle.L clothes then AGR take
 chuli' si Jose i balutan.
 UNM Jose the bundle
 'A bundle of clothes came floating from the channel...Then Jose grabbed the bundle.' (Cooreman 1983: 107)

⁵Some details are glossed over because they are irrelevant. E.g. *che'lu* 'sibling' is inflected for singular, dual, and plural number; the other five nouns are inflected for nonplural versus plural number. For these five nouns, the nonplural (unmarked) form can be construed as singular or dual; the dual construal arises if and only if the noun is combined with the numeral *dos* 'two'.

- b. Anai ma baba, humuyung pátgun ... Pues esti na pátgun
when AGR open AGR.come.out child then this L child secret
 sikretu mo'na sigi ha' di ha poksai.
forward keep.on EMP AGR raise
 'When they opened it, a child came out....So this child they kept on
 raising secretly from then on.' (Cooreman 1983: 107)
- c. Siempri guaha nai maná'i hao dangis hálum ya gígun
surely AGR.exist COMP AGR.PASS.give you candle inside and as.soon.as
 un gu'ut, malingu.
AGR grasp AGR.disappear
 'Surely there will be times when you are given a candle inside and as
 soon as you grasp it, it disappears.' (Cooreman 1983: 4)

These patterns suggest that Chamorro's narrow-scope indefinites are better handled by C&L's account than by Farkas and de Swart's or Espinal and McNally's. I will assume this for now, returning to the issue at the end.

A more familiar range of options is available for the compositional semantics of DPs formed from *i* or *un*. For instance, *i* could be a type-shifter from properties to individuals (e.g. Partee's (1987) *iota*) or from properties to generalized quantifiers (e.g. a version of Partee's (1987) *the* in which existence and uniqueness are presupposed; see Coppock and Beaver 2015: 383); *un* could be a type-shifter from properties to individuals (e.g. a choice function; see Reinhart 1997, Winter 1997, Kratzer 1998, C&L 2004) or from properties to generalized quantifiers (e.g. Partee's (1987) *A*). I believe it is unimportant for my purposes which of these options is adopted. What matters is that *i* and *un* are type-shifters that enable the descriptive content of DP to be composed with the predicate's relatum by Function Application. This differentiates them from the null indefinite article, which signals that the descriptive content of DP is composed with the predicate's relatum by Restrict.

With this much in place, I now move on to MP, which provides a dimension along which indefinites formed from the null indefinite article are *less* constrained than indefinites formed from *un*.

4 MAXIMIZE PRESUPPOSITION: THE BASICS

Heim (1991) observed that there seems to be a condition that urges speakers to avoid the indefinite article if they can use the definite article. (For different approaches to roughly the same material, see Hawkins 1978: 175-191 and 1991: 432-434). She identified two sorts of contexts in which the condition is at work. First, in contexts in which the uniqueness presupposition carried by the definite article is already known to be satisfied, use of the indefinite article is infelicitous. This is what Percus (2006) refers to as antipresupposition. What goes wrong in (13), for instance, is that the indefinite article is used although it is normally taken for granted that each concrete object has a unique weight.

- (13) #A weight of our tent is under 2 kilos. (Heim 1991: 51)

Second, in contexts in which the uniqueness presupposition carried by the definite article is *not* already known to be satisfied, use of the indefinite article implicates that the speaker believes that the extra information that the definite article would have communicated is false (see note 3). This is what Leahy (2016) calls *presuppositional implicature*. In (14), for instance, the use of *a pianist* rather than *the pianist* aggressively invites the inference that the pianist who Richard had a beer with is not the pianist of the Beaux Arts Trio.

- (14) Richard heard the Beaux Arts Trio last night and afterwards had a beer with a pianist. (Heim 1991: 515)

Although Heim noted that the condition at work in (13-14) is reminiscent of scalar implicature, she claimed that it could not be accounted for in the same way. Her reason was that scalar implicatures are usually derived from Grice's maxim of quantity ('Make your contribution as informative as is required'), but given that it is common knowledge that each concrete object has a unique weight, an example like (13) is not less informative than its felicitous counterpart (15).

- (15) The weight of our tent is under 2 kilos.

She suggested that the privileging of the definite over the indefinite article might instead follow from a new conversational maxim, 'Make your contribution presuppose as much as possible!'—the maxim now known as MP.

There has been an explosion of research on MP since the turn of the century. Its empirical domain has been widened to include other pairs of lexical items that differ in presuppositional strength (e.g. *both* and *all*, *know* and *believe*; see Percus 2006), as well as certain types of inflectional morphology (e.g. tense, number agreement; see Sauerland 2003 and 2008). Considerable effort has been devoted to crafting a more precise formulation of MP and integrating it in one way or another into a Gricean model of reasoning (see e.g. Schlenker 2012, Leahy 2016, Lauer 2016). Other research has probed the question of whether the alternatives compared by MP are lexical items or more complex expressions consisting of clauses or sentences plus their interpretations (see e.g. Percus 2006, Singh 2011, Schlenker 2012, Lauer 2016, Collins 2016).

The goal of this discussion is to use the interplay between Chamorro's article system and MP to provide evidence for C&L's modes of composition. Because I am interested primarily in the effects attributed to MP, I will not need to commit to any formulation of it more precise than Heim's. In section 8, however, I will briefly engage with some larger questions that emerge from the Chamorro material investigated here.

5 PRESUPPOSITIONAL IMPLICATURE

Given that Chamorro *i* carries a uniqueness presupposition that the indefinite articles lack, we expect the indefinite articles to exhibit presuppositional impli-

capture effects. In contexts in which *i*'s uniqueness presupposition is not already known to be satisfied, use of an indefinite article should implicate that, for all the speaker knows, the extra information that *i* would have communicated is false. This is in fact what happens. Consider a discourse in which the speaker utters (16), followed by one of the sentences in (17), which differ only in the article used to form the underlined DP.

- (16) Humânao yu' para i fandânggu gi egga'an.
AGR.go I to the wedding LOC morning
 'I went to the wedding celebration in the morning.'
- (17) a. Dispues, gi talu'âni, hu li'i' i nobia.
then LOC afternoon AGR see the bride
 'Then, in the afternoon, I saw the bride.'
- b. Dispues, gi talu'âni, hu li'i' un nobia.
then LOC afternoon AGR see a bride
 'Then, in the afternoon, I saw a bride.'
- c. Dispues, gi talu'âni, hu li'i' nobia.
then LOC afternoon AGR see bride
 'Then, in the afternoon, I sighted a bride.'

An utterance of (17a), with the definite article, can be felicitously used to report that the speaker saw the bride from the wedding s/he attended earlier that day. But an utterance of (17b), with *un*, implies that the speaker saw a bride from a different wedding, or perhaps the wedding that the speaker attended involved multiple brides. (As one consultant said, "We are assuming here several weddings happened or it could be a polygamous wedding!") That is, (17b) implicates that there is more than one bride in the domain of discourse. An utterance of (17c), with the null indefinite article, has the same non-uniqueness implication. (The consultant commented, "Interesting sentence. Translation: Afterwards, I sighted (a) bride (could be any bride).")

A discourse in which the speaker utters one of the sentences in (18) gives rise to similar effects. Note that *mâkina* means 'engine, machine'.

- (18) a. Hu sugun i kareta, pues mayamak i mâkina.
AGR drive the car then AGR.PASS.break the engine
 'I drove the car, then the engine broke.'
- b. Hu sugun i kareta, pues mayamak un mâkina.
AGR drive the car then AGR.PASS.break a engine
 'I drove the car, then an engine / machine broke.'
- c. ?? Hu sugun i kareta, pues mayamak mâkina.
AGR drive the car then AGR.PASS.break engine
 'I drove the car, then an engine / machine broke.'

The most natural understanding of an utterance of (18a), with the definite article, is that the speaker drove the car and then the engine of that car broke. However, an utterance of (18b), with *un*, implies that a machine broke which might or might not be the engine of the car the speaker drove. (The consultant commented, “Could mean one part of the car’s engine broke or some other machine broke, or could be [that] a machine he was transporting in the car broke.”) An utterance of (18c), with the null indefinite article, licenses this inference as well. (“Not clear which machine.”)

A comment is in order about the status of (17c) and (18c). In Chamorro, DPs formed from the null indefinite article routinely serve as arguments in naturally-occurring discourse and in sentences volunteered by speakers in fieldwork sessions. Consider the sentences below, which are parallel in the relevant respects to (17c) and the last clause of (18c).

- (19) a. *Ma lili’i paláo’an na á’paka’ magagu-ña ...*
AGR see.PROG woman COMP AGR.white clothes-AGR
 ‘[Sometimes] they saw a woman with white clothes...’ (Cooreman 1983:3)
- b. *Mayulang siya.*
AGR.PASS.break chair
 ‘A chair broke.’

However, speakers sometimes report that mini-discourses like (16-17c) or (18c) are incomplete, leave the listener hanging, or are not really grammatical. The dissonance seems more pronounced when the DP is inanimate, as in (18c). I believe these reactions reflect the fact that these discourses are not very good discourses. DPs formed from the null indefinite article typically introduce discourse referents that are not salient. However, the design of the mini-discourses and their presentation as minimal triplets serves to draw attention to the discourse referents these DPs introduce. The heightened salience could well lead to the judgment that in this particular context, a DP formed from the null indefinite article does not supply enough information for the discourse to cohere. Mini-discourses like (16-17b) and (18b), with a DP formed from *un*, do not encounter the same issue, because DPs formed from *un* can introduce discourse referents that are salient.

(In Chamorro, the antipassive voice signals explicitly that the internal argument is not salient. In a discourse in which the speaker utters (16), followed by one of the antipassive sentences in (20), both types of indefinites are readily accepted, and the pattern of presuppositional implicature is similar to what was reported for (17-18).⁶

⁶The oblique case marker *ni* merges with the definite article *i* in (20a) and is unpronounced when the DP is indefinite.

- (20) a. Ya gi talu'ãni manbisita yu' ni nobiu.
and LOC afternoon AGR.AP.visit I OBL.the groom
 'And in the afternoon I visited with the groom [= the groom from the wedding earlier that day].'
- b. Ya gi talu'ãni manbisita yu' un nobiu.
and LOC afternoon AGR.AP.visit I a groom
 'And in the afternoon I visited with a groom.' [It might or might not be the groom from the wedding earlier that day.]
- c. Ya gi talu'ãni manbisita yu' nobiu.
and LOC afternoon AGR.AP.visit I groom
 'And in the afternoon I visited with a groom.' [It might or might not be the groom from the wedding earlier that day.]

However, not all speakers are comfortable with mini-discourses like (17-20a), in which the internal argument of the antipassive verb is definite, even though such constructions are grammatical elsewhere. The loose trade-off between voice, definiteness, and salience seen above exhibits considerable individual variation; it clearly deserves further study.)

Abstracting away from the intricacies, the presuppositional implicature effects in (17-18) reveal that the use of definite and indefinite articles in Chamorro conforms to MP as expected. I provisionally take this to mean that the three articles are arranged in a presuppositional scale in which the definite article *i* is the strong member and either *un* or the null indefinite article is the weak member. It will be convenient later for me to decompose this into two simpler presuppositional scales, one consisting of *i* and *un* and the other consisting of *i* and the null indefinite article. In Horn's (2001[1989]: 231) formalism, in which the stronger member of the scale occurs to the left of the weaker member, these scales are $\langle i, un \rangle$ and $\langle i, \text{null} \rangle$.

Over and above this, we have now arrived at another argument that the null indefinite article exists in the first place (see section 2). In the literature on MP, the members of presuppositional scales are sometimes assumed to be lexical items that are members of the same syntactic category (see Percus 2006 for explicit discussion). If we adopt this assumption, then the fact that the null indefinite article forms a presuppositional scale with *i* is evidence that it is a lexical item and, further, belongs to the same category as *i*. It is a D that happens not to be pronounced, in other words.

6 ANTIPRESUPPOSITION, PART 1

The claim that Chamorro articles conform to MP leads to the expectation that the indefinite articles should exhibit antipresupposition effects. Here the empirical patterns are more complex, so the discussion is divided into two parts. I begin by exploring antipresupposition effects involving nouns whose meaning, together with common knowledge, communicates that the possessee is unique relative to

the possessor (e.g. *gui'ing* 'nose'). But for the investigation to get off the ground, some background must be installed about the form and meaning of Chamorro DPs that contain a possessor, which—following Barker 1991—I call *possessives*.

6.1 CHAMORRO POSSESSIVES: THE BASICS

Possessives in Chamorro have a possessor that occurs high within DP, following the noun and outside the NP constituent consisting of the noun, its complements, and modifiers (see Chung 1998 and 2006). The noun either shows (suffixal) agreement with the possessor or else is inflected with the linker (glossed *L*).⁷ The possessor is enclosed in brackets below.

- (21) a. *neni-ña* [*si Dolores*]
baby-AGR UNM Dolores
 'a baby of Dolores'
- b. *nenin* [*Dolores*]
baby.L Dolores
 'a baby of Dolores'

D and the possessor coexist and covary freely. Consider the examples below, which make the point that a possessive can be formed from any article—*i*, *un*, or null—and, moreover, the possessor can be any type of DP. (The overt articles in (22) are in bold-face, and pronoun possessors are represented as *pro*; see note 7.)

- (22) a. ***i*** *hugetin* [***i*** *neni*]
the toy.L the baby
 'the toy of the baby'
- b. ***i*** *gapitulun* [*patgon-ña* [*pro*]]
the hair.L child-AGR
 'the hair of a child of hers'
- c. ***un*** *kannai-ña* [*pro*]
a arm-AGR
 'an arm of his' (CD, entry for *mångku*)
- d. ***un*** *balutan* [*kandi*]
a bag.L candy
 'a bag of candy' (CD, entry for *ápatti*)
- e. *pão-ña* [***i*** *sadduk*]
smell-AGR the river
 'an(y) odor of the river'

⁷The linker is realized as *-n* when the noun ends in a vowel and unrealized otherwise. Generally, the choice between the linker and possessor is free. However, possessors that are pronouns must be null, and the possessed noun must agree with them.

- f. che'chu' [**un** tâotao]
work.L a person
 'work of a (i.e. one) person' (heard at a meeting)
- g. patgun [tâotao]
child.L person
 'a child of a person'

Just as for other DPs, the definiteness of a possessive is determined by the definiteness of the D from which it is formed. I take this to be self-evident for possessives formed from the articles *un*. and *un*. (For some evidence, read on to section 6.2.) One might wonder about the status of possessives formed from the null indefinite article, given Barker's (2011) claim that English possessives like Meg's cat, which have no overt article, inherit their familiarity and uniqueness from their possessor. (Relatedly, it has sometimes been claimed that English prenominal possessives are definite; see e.g. Jensen & Vikner 2002: 200-201 and, for discussion, Barker 2000 and 2011). However, there is abundant evidence that in Chamorro, *a possessive formed from the null indefinite article has the morphosyntax and semantics of an indefinite*, even when the possessor is definite. Chamorro possessives do not inherit their definiteness from the possessor, in other words (see Chung 2006). Here is some of the evidence:

(i) A possessive formed from the null indefinite article can serve as the pivot of an existential sentence (see (23a-b)), but a possessive formed from the definite article cannot (see (23c)).

- (23) a. Guaha difekton-ña [i adding [i taotao]].
AGR.exist defect-AGR the leg.L the person
 'The person's leg has a defect (lit. There is a defect of the leg of the person).' (EM 133)
- b. Tãya' patgon-ña [pro].
AGR.not.exist child-AGR
 'There isn't a child of hers / She doesn't have a child.'
- c. *Tãya' i patgon-ña [pro].
AGR.not.exist the child-AGR
 (There isn't the child of hers.)

(ii) A possessive formed from the null indefinite article cannot occupy the syntactic topic position at the left edge of the clause (see (24a)). However, a possessive formed from the definite article can (see (24b)).

- (24) a. *Ga'-mu [pro] ha na'dãnu i gualu'.
pet-AGR AGR cause.damage the garden
 (A dog of yours destroyed the garden.)
- b. I ga'-mu [pro] ha na'dãnu i gualu'.
the pet-AGR AGR cause.damage the garden
 'Your dog destroyed the garden.'

(iii) Possessives formed from the null indefinite article exhibit quantificational variability, but possessives formed from the definite article do not, or do so with greater difficulty. The most immediate interpretation of (25a) is that a different child of hers gets sick on different occasions, whereas the most immediate interpretation of (25b) is that the same child gets sick on multiple occasions.

- (25) a. Kada malāngu patgon-ña [*pro*], tristi gui'.
every.time AGR.sick child-AGR AGR.sad she
 'Every time a child of hers gets sick, she's sad.'
- b. Kada malāngu i patgon-ña [*pro*], tristi gui'.
every.time AGR.sick the child-AGR AGR.sad she
 'Every time her child gets sick, she's sad.'

(iv) Possessives formed from the null indefinite article are nonreferring in opaque contexts (see (26a)). However, possessives formed from the definite article are referring even in these contexts (see (26b)).

- (26) a. Malagu' si Jose mañodda' asaguã-ña [*pro*].
AGR.want UNM Jose INFIN.AP.find spouse-AGR
 'Jose wants to find a wife (of his).' [He has no wife; he's not married yet.]
- b. Malagu' si Jose mañodda' nu i asaguã-ña [*pro*].
AGR.want UNM Jose INFIN.AP.find OBL the spouse-AGR
 'Jose wants to find his wife.' [He already has a wife, but she's not in the vicinity.]

(v) Finally, question-answer pairs reveal that a possessive formed from the null indefinite article does not presuppose uniqueness (maximality). Consider a scenario in which B and C both know that Antonio has siblings, but only C knows that some of Antonio's siblings are smart and some are not smart. Suppose that B asks the question in (27a), with a possessive formed from the null indefinite article. When asked how C would respond, speakers volunteered the responses in (27b) as the first or most natural answer. (Other answers are possible.) These responses reveal that the question was understood to be about one or more of Antonio's siblings.⁸

- (27) a. B: Kao manmalāti' mañe'lu-ña [*si Antonio*]?
Q AGR.smart siblings-AGR UNM Antonio
 'Are siblings of Antonio smart?'
- b. C: Guaha ha' / Hunggan.
AGR.exist EMP yes
 'There are some. / Yes.'

⁸Possessives formed from the null indefinite article can serve as subjects of individual-level predicates, but only when their possessor is strong; see Chung 2006.

Now suppose that B instead asks the question in (28a), with a possessive formed from the definite article. When asked how C would respond, the same speakers volunteered (28b). Here, the responses reveal that the question was understood to be about all of Antonio’s siblings.

- (28) a. B: Kao manmalâti’ i mañe’lu-ña [si Antonio]?
q AGR.smart the siblings-AGR UNM Antonio
 ‘Are Antonio’s siblings smart?’
- b. C: Ti todú. / Áhi.
not all no
 ‘Not all. / No.’

The contrast between (27) and (28) is evidence that Chamorro possessives do not inherit uniqueness from their possessors. Instead, possessives formed the definite article presuppose uniqueness; possessives formed from the null indefinite article do not.

The possessor in a Chamorro possessive can bear any semantic relation at all to the (possessed) noun. Nonetheless, the discussion here focuses on relational nouns—nouns that denote a relation identical to what Barker (1991 and 2011) calls the possession relation.

6.2 ANTIPRESUPPOSITION IN POSSESSIVES

We are now ready for antipresupposition. Suppose the noun of a possessive is a relational noun such as *gui’ing* ‘nose’, *kurason* ‘heart’, or *nána* ‘mother’, for which it is common knowledge that the possessee is unique relative to the possessor. Because this is a context in which *i*’s uniqueness presupposition is already known to be satisfied, the use of either indefinite article should be infelicitous.

Here, the two indefinite articles pull apart. The use of *un* is indeed infelicitous, as (29) shows.

- (29) a. # Kumâتما i bongbung un kurason-ña [*pro*].
AGR.calm the beat.L a heart-AGR
 ‘The beating of a heart of hers calmed down.’
- b. # Hu mokmuk un pachot-tu [*pro*].
AGR rinse a mouth-AGR
 ‘I rinsed a mouth of mine.’
- c. # Mañisiha un nanâ-hu [*pro*] yan i mankiñadâ-ña siha.
AGR.together.PROG a mother-AGR and the sisters.in.law-AGR PL
 ‘A mother of mine and her sisters-in-law were together.’

But, surprisingly, the use of the null indefinite article is felicitous. In fact, the null indefinite article occurs quite often in this context, as the following naturally-occurring examples are intended to illustrate.

- (30) a. Kumâ^{AGR}ta i bongbung kurason-ña [*pro*].
AGR.calm the beat.L heart-AGR
 ‘The beating of her heart (lit. a heart of hers) calmed down.’ (EM 82)
- b. Kada ogga’an, hu mokmuk pachot-tu [*pro*].
each morning AGR rinse mouth-AGR
 ‘Every morning, I rinse my mouth (lit. a mouth of mine).’ (CD, entry for *mokmuk*)
- c. Chamoru nanâ-hu [*pro*], Chamoru tatâ-hu [*pro*].
Chamorro mother-AGR Chamorro father-AGR
 ‘My mother (lit. a mother of mine) is Chamorro, my father (lit. a father of mine) is Chamorro.’ (from a conference presentation)
- d. Manâgu’ na u ma’utut aga’gâ’-ña [*si Juan*] gi presu.
AGR.AP.order COMP AGR PASS.cut throat-AGR UNM Juan LOC prison
 ‘He ordered that John’s throat (lit. a throat of John) be cut in the prison.’ (NT 27)
- e. Singku bibenda linekkâ’-ña [*atyu na guma*].
five storeys height-AGR that L house
 ‘The (lit. a) height of that building is five storeys.’ (CD, entry for *linekka*)
- f. Anâkku’ dadalak-ña [*i hafula*].
AGR.long tail-AGR the manta.ray
 ‘The (lit. a) tail of the manta ray is long.’ (CD, entry for *hafula*)
- g. Hâfa na mampus amariyu kulot-mu [*pro*]?
what? COMP too.much AGR.yellow color-AGR
 ‘Why is your color (lit. a color of yours) so yellow?’ [addressed to a canary] (EM 82)

I should emphasize that the possessives in (30) can be shown to be indefinite by the same sorts of evidence I used in section 6.1 to make this point more generally for possessives formed from the null indefinite article. Even when the relational noun’s meaning, together with common knowledge, communicates that the possessee is unique relative to the possessor, the possessive can be the pivot of an existential sentence, cannot occupy the syntactic topic position, and is nonreferring in opaque contexts (see the Appendix for some relevant examples). Moreover, the use of the definite article is also felicitous in this context, just as MP leads us to expect. Compare (30a), (30c), and (30f) with the examples below.

- (31) a. Hâfa na ti pasifiku i kurason-ña [*pro*].
whatever comp not agr.peaceful the heart-agr
 ‘For whatever reason, his heart is not calm.’ (EM 128)
- b. U niñukut ni tilipas apuya’ i nanâ-ña [*pro*].
agr pass.strangle obl umbilical.cord the mother-agr
 ‘It will be strangled by the umbilical cord of its mother.’ (CD, entry for *chathinenggi*)

c. Hingao i dadalak-ña [i ga'lâgu].

agr.hairless the tail-agr the dog

The tail of the dog is hairless.' (CD, entry for *dádalak*₂)

What has changed the playing field? Descriptively, it looks like the scale <*i, un*> remains in force for antipresupposition, but for some reason, <*i, null*> has been suspended.

The idea that the null indefinite article does not form a scale with *i* for antipresupposition purposes is supported by the discourse patterning of possessives of types (30) and (31). When it is common knowledge that the possessee is unique relative to the possessor, a possessive that explicitly introduces the discourse referent corresponding to the possessee can be formed from the null indefinite article or from *i*.

(32) a. Ti siña masugun i kareta, sa' mayulang makinã-ña [pro].

not can AGR.PASS.drive the car bec. AGR.PASS.break engine-AGR

'The car can't be driven, because its engine (lit. an engine of it) is broken.'

b. Ti siña masugun i kareta, sa' mayulang i makinã-ña [pro].

not can AGR.PASS.drive the car bec. AGR.PASS.break the engine-AGR

'The car can't be driven, because its engine (lit. the engine of it) is broken.'

Moreover, a possessive that refers back to a previously introduced discourse referent can itself be formed from the null indefinite article or from *i*.⁹ The following examples from narratives illustrate this point.

(33) a. Kulan hu dimimoria na'ân-ña atyu na mediku. Kulan Foot

seems.like AGR memorize name-AGR that L doctor seems.like Foot

na'ân-ña [atyu na mediku].

name-AGR that L doctor

'It seems like I recall the (lit. a) name of that doctor. It seems like the (lit. a) name of that doctor was Foot.' (Cooreman 1983: 12)

b. Guiya esti i nanã-ta as Santa Maria, nanan [i Saina-ta]

she this the mother-AGR OBL Saint Mary mother.L the parent-AGR

as Jesu Kristu i Yu'us ni lãla'la'.

OBL Jesus Christ the God COMP AGR.alive.PROG

'This was our mother, the Virgin Mary, the (lit. a) mother of our father Jesus Christ the living God.' (Cooreman 1983: 22)

c. Pumoddung i santus ya kã'ka' matã-ña ... Tãya' Guam

AGR.fall the saint and AGR.crack face-AGR AGR.not.exist Guam

tumungu' fuma'mãolik i fasu-ña [pro].

WH.know INFIN.repair the face-AGR

'The [statue of the] saint fell and her face (lit. a face of her) cracked ... [She was sent to the Philippines because] no one in Guam knew how to repair her face (lit. the face of her).' (Cooreman 1982: 27)

⁹Thanks to Louise McNally for pointing out the importance of investigating this.

These patterns suggest that it would not work to try to claim that Chamorro has two homophonous definite articles, one that differs from *un* in presupposing uniqueness and another that differs from the null indefinite article in presupposing familiarity (along the lines suggested for Spanish by Alonso-Ovalle et al. 2011). Rather, in antipresupposition contexts, the null indefinite article seems not to enter into competition with the definite article at all.¹⁰

7 ANTIPRESUPPOSITION, PART 2

Another antipresupposition context is supplied by nouns whose intended referent is commonly understood to be unique in the real world, such as *âtdao* ‘sun’ or *lângit* ‘sky’. Once again, because *i*’s uniqueness presupposition is already known to be satisfied, MP leads us to expect that the use of an indefinite article should be infelicitous. This expectation is realized for *un*, as can be seen from the minimal pair below.

- (34) a. # Dodokku’ un âtdao.
AGR.sprout.PROG a sun
 ‘A sun is rising.’ [Infelicitous, according to one consultant, because “we all know that there is only one sun in our solar system”.]
- b. Dodokku’ i atdao.
AGR.sprout.PROG the sun
 ‘The sun is rising.’

What about the null indefinite article? No clear information about (in)felicity emerges from sentences like (35), because these sentences are simply rejected as ungrammatical.

- (35) * Dodokku’ âtdao.
AGR.sprout.PROG sun
 (A sun is rising.)

However, when the noun is accompanied by a modifier, as in (36), speakers report that the use of the null indefinite article is both grammatical and felicitous.

- (36) Dodokku’ / Kumahulu’ dângkulu na âtdao.
AGR.sprout.PROG / AGR.go.up big L sun
 ‘A big sun is rising / went up (higher in the sky).’ [The same consultant commented, “This is okay because it can mean that when the sun rose it was big.”]

Significantly, the use of *un* remains infelicitous.

¹⁰The possibility that Chamorro might have two null determiners is discussed in the Appendix.

(37) # Kumahulu' un dångkulu na âtdao.

AGR.go.up a big L sun

'A big sun went up (higher in the sky).' [Infelicitous, according to another consultant, because "we all know that there is only one sun (for earth, that is)."]

One way of describing the pattern in (34-37) is to say that when it is common knowledge that the noun's intended referent is unique in the real world, the scale <*i, un*> remains in force, but <*i, null*> is suspended *as long as the null indefinite article is grammatical to begin with*.¹¹ Once the issue of grammaticality is factored in, the pattern replicates what was seen in section 6.2. This suggests that <*i, null*> is suspended for antipresupposition in general.

I do not know why (35) is ungrammatical. However, I should point out that there are naturally-occurring examples in which the null indefinite article is used with an unmodified noun of this type. A few sentences of this type are cited below.

(38) a. Bula na amonestasion put tâsi.

AGR.much L warning about ocean

'There is a lot of warning about the sea.' (CD, entry for amonestasion)

b. Ha chuda' i mina'kuâttru na ânghit i tason-ña gi hilu' âtdao.

AGR pour the fourth L angel the bowl-AGR LOC top.L sun

'The fourth angel poured out his bowl on the sun.' (NT 476)

Compare the naturally-occurring examples in (39), which are similar but use the definite article instead.

(39) a. Astaimânu chinago'-ña i lugât-mu ginin i tasi?

how.far? distance-AGR the place-AGR from the ocean

'How far is your place from the ocean?' (CD, entry for *astaimânu*)

b. Hu li'i' un ânghit tumotohgi gi hilu' i âtdao.

AGR see a angel AGR.stand.PROG LOC top.L the sun

'I saw an angel standing on the sun.' (NT 481)

Although sentences like (38) are not particularly common, the fact that they are attested at all supports the claim that <*i, null*> is suspended for antipresupposition. (Note that there are no sentences in the CD database or NT in which *un* forms a DP with the nouns *âtdao* 'sun', *pulan* 'moon', *tâsi* 'ocean', or *lângit* 'sky'.)

8 THE LARGER PICTURE

To sum up, Chamorro's two indefinite articles respond differently to MP. Both indefinite articles exhibit presuppositional implicature effects, but only *un* exhibits

¹¹Cf. Collins' (2016) Well-formedness principle: "If F and F' are pragmatic alternatives, then F and F' are grammatically well-formed" (Collins 2016: 98).

antipresupposition effects; the null indefinite article does not. In this concluding section, I first tentatively suggest an account of this pattern, and then step back and survey the larger consequences of the investigation for the typology of narrow-scope indefinites.

Perhaps the most straightforward story one could tell about the antipresupposition effects in sections 6 and 7 would claim that *i* and *un* form a presuppositional scale for the purposes of MP, but—contrary to what I suggested earlier in section 5—*i* and the null indefinite article do not. This would not be particularly surprising, given that scales—e.g. the scales relevant for scalar implicature—are known to be lexically arbitrary (see, e.g., Horn 1972 and Hirschberg 1985). The claim that *i* fails to form a presuppositional scale with the null indefinite article could be motivated by appealing to the different composition operations they signal. Recall that for C&L, the null indefinite article signals that the descriptive content of DP is composed with the predicate by Restrict, an operation that narrows the domain of the predicate's relatum but does not saturate it. On the other hand, *i* and *un* are type-shifters that enable the descriptive content of DP to be composed with the predicate's relatum by Function Application. This suggests that *i* and *un* are similar enough to count as paradigmatic alternatives—the sorts of lexical entries that can be members of a scale (see Horn and Abbott 2014)—but *i* and the null indefinite article do not satisfy this criterion.

How would this story handle the fact that both *un* and the null indefinite article exhibit presuppositional implicature effects? Most likely, it would have to say that these patterns do not result from MP, but rather from a generalized scalar inference that recognizes both $\langle i, un \rangle$ and $\langle i, null \rangle$ as scales.¹² This position, though stipulative, is credible, since it has never been entirely clear whether antipresupposition and presuppositional implicature should be given a unified account. Leahy makes this point explicitly:

Theories of presuppositional implicature have different explanatory goals from theories of antipresupposition. Theories of antipresupposition aim to explain why utterances of presuppositionally weak alternatives are infelicitous in contexts that satisfy the presupposition of a presuppositionally stronger alternative. Theories of presuppositional implicature aim to explain why felicitous utterances of presuppositional weak alternatives...generate cancellable information that is not part of the asserted or presupposed content. (Leahy 2016: 86; emphasis in the original)

Leahy goes on to propose an account of scalar implicature that is broad enough to

¹²Chris Barker asks whether the relevant Horn scale is $\langle i, un, null \rangle$. This is a good question that I am not yet prepared to answer. On a different note, Deniz Rudin suggests that speakers' responses to (16-17) and (18) could be taken to indicate that the null indefinite article does not exhibit presuppositional implicature effects, contrary to what I claimed in section 5. Were that the case, the null indefinite article would be well-behaved with respect to a unified MP—it would not exhibit either of the effects attributed to that principle—but it would not enter into competition with the other articles at all. Serious discussion of this idea must await a more detailed study of the sorts of contrasts presented in section 5.

incorporate presuppositional implicature—but not necessarily antipresupposition—as a special case.

Notice now that the story I have just told about Chamorro indefinites and antipresupposition could be reconstructed in *any* approach that posits that the descriptive content of a narrow-scope indefinite is composed directly with the predicate.

In this respect, C&L's account of Chamorro's narrow-scope indefinites is not unique. The reasons for preferring it lie elsewhere—in the patterns of semantic number and discourse dynamics discussed in section 3.

From the standpoint of the typology of indefinites, the pattern of antipresupposition documented above is noteworthy, because it reveals a dimension along which narrow-scope indefinites can have a less limited distribution than scopally unrestricted indefinites in the same language. The observation raises some questions. How do narrow-scope indefinites in other languages—bare NPs in particular—fare with respect to antipresupposition? Is the absence of antipresupposition effects characteristic of narrow-scope indefinites more generally? How, if at all, does the absence of these effects connect with semantic number and the ability to contribute a discourse referent?

The broader point to emerge is that there are types of narrow-scope indefinites that are not severely restricted along multiple dimensions. In a way, this is not surprising, if one takes seriously the semantic-pragmatic parallels between narrow-scope indefinites and incorporees in morphosyntactic noun incorporation. Following Van Geenhoven (1998), research has focused on narrow-scope indefinites whose semantic-pragmatic deficiencies closely parallel the semantic-pragmatic limitations on incorporees in Mithun's (1984) Type I and Type II incorporation. But Mithun also recognized a type of incorporation (Type III) in which the incorporee can be construed as familiar or unique. Perhaps the profile of Chamorro indefinites formed from the null indefinite article can be understood in this light. I hope to have helped to open up the exploration of this territory; a more thoroughgoing investigation must be left to another time.

APPENDIX: A ROAD NOT TAKEN

Given the empirical patterns in section 6, one might be tempted to try to float the alternative proposal that Chamorro has not one, but two null determiners: a null indefinite article that is compatible with a possessor (see sections 2 and 6.1), and a null definite article that obligatorily selects a possessor.¹³ Under such a proposal, a possessive formed from a null determiner, such *kurason-hu* 'my heart', would be systematically ambiguous between an analysis as an indefinite DP and an analysis as a definite DP. This sort of systematic ambiguity could handle certain facts presented earlier. For instance, possessives formed from a null determiner would be indefinite when they occur as pivots of existential sentences.

¹³Thanks to Chris Barker for raising this sort of possibility. One can imagine several versions of the two-null-determiners proposal, but I believe all are subject to the objections raised in the text.

(Their definite counterparts would be excluded just like possessives formed from *i*.) Similarly, possessives formed from a null determiner would be definite, and felicitous, when their possessee is commonly understood to be unique, as in (30). (In accordance with MP, their indefinite counterparts would be infelicitous, just like possessives formed from *un*.)

The problem with the two-null-determiner proposal is that it makes other predictions that are incorrect. For instance:

- A possessive formed from a null determiner cannot occupy the left-edge topic position in Chamorro. In this respect, it differs from definite DPs; see (24). Note that such a possessive cannot serve as the topic even when it is common knowledge that the possessee is unique, as (40) shows. (In an attempt to be even-handed, I translate the possessives below as Saxon genitives.)

(40) * Tatâ-ña [si Miguel] ha hâtsa atyu na guma'.
father-AGR UNM Miguel AGR build that L house
 (Miguel's father built that house.)

- A possessive formed from a null determiner cannot be construed as referring in opaque contexts. In this respect too, it differs from definite DPs; see (26). The example below shows that such a possessive cannot be construed as referring even when it is common knowledge that the possessee is unique.

(41) Malagu' si Jose na u fañodda' tatâ-ña [pro].
AGR.want UNM Jose COMP AGR AP.find father-AGR
 'Jose wants to find his father.' [He's looking for a foster parent; or he's illegitimate and wants to have a father.]

- In Chamorro, subjects of transitive clauses and other external arguments must be specific (see Chung 1998: 102-111). A possessive formed from a null determiner cannot serve as the subject of a transitive clause, even when it is common knowledge that the possessee is unique. This is another respect in which these possessives differ from definite DPs.

(42) a. * Kao ha na'la'lu nanan [atyu na pâtgun] i sapâtus?
Q AGR return mother.L that L child the shoes
 (Did that child's mother return those shoes?)
 b. Kao ha na'la'lu i nanan [atyu na pâtgun] i sapâtus?
Q AGR return the mother.L that L child the shoes
 'Did that child's mother return those shoes?'

- Question-answer pairs involving a possessive formed from a null determiner reveal that these possessives are construed as nonmaximal. This is a further difference between these DPs and definite DPs; see (27-28).

The bottom line is that possessives formed from a null determiner do not behave as if they were systematically ambiguous between definites and indefinites. In short, the idea that Chamorro might have two null determiners is not viable.

REFERENCES

- Alonso-Ovalle, Luis, Paula Menéndez-Benito, and Florian Schwarz. 2011. Maximize Presupposition and two types of definite competitors. *Proceedings of NELS 39*, vol. 1, ed. Suzi Lima, Kevin Mullin, and Brian Smith, 29-40. Amherst, MA: Graduate Linguistics Student Association.
- Barker, Chris. 1991. Possessive descriptions. Ph.D. dissertation, University of California, Santa Cruz.
- Barker, Chris. 2000. Definite possessives and discourse novelty. *Theoretical Linguistics* 26: 211-227.
- Barker, Chris. 2011. Possessives and relational nouns. In: *Semantics: An international handbook of natural language meaning*, vol. 2, ed. C. Maienborn, K. von Stechow, and P. Portner, 1109-1130. Berlin: Mouton de Gruyter.
- Borja, Joaquin F., Manuel F. Borja, and Sandra Chung. 2006. *Estreyas Marianas: Chamorro*. Saipan, CNMI: Estreyas Marianas Publications. [EM]
- Chung, Sandra. 1998. *The design of agreement: Evidence from Chamorro*. University of Chicago Press.
- Chung, Sandra. 2006. Possessors and definiteness effects in two Austronesian languages. In: *Quantification: A cross-linguistic perspective*, ed. Lisa Matthewson, 179-224. Bingley, UK: Emerald.
- Chung, Sandra and William A. Ladusaw. 2004. *Restriction and saturation*. Cambridge, MA: MIT Press.
- Chung, Sandra and William A. Ladusaw. 2006. Chamorro evidence for compositional asymmetry. *Natural Language Semantics* 14: 325-357.
- Collins, James N. 2016. Reasoning about definiteness in a language without articles. In: *Proceedings of SALT 26*, ed. M. Moroney, C.-R. Little, J. Collard, and D. Burgdorf, 82-102. Linguistic Society of America.
- Cooreman, Ann. 1982. *Chamorro texts*. Ms., University of Oregon.
- Cooreman, Ann. 1983. *Chamorro texts*. Ms., University of Oregon and Saipan, CNMI.
- Coppock, Elizabeth and David Beaver. 2015. Definiteness and determinacy. *Linguistics and Philosophy* 38: 377-435.
- Espinal, M. Teresa and Louise McNally. 2011. Bare nominals and incorporating verbs in Spanish and Catalan. *Journal of Linguistics* 47: 87-128.
- Farkas, Donka F. and Henriëtte de Swart. 2003. *The semantics of incorporation*. Stanford, CA: CSLI.
- Hawkins, John A. 1978. *Definiteness and indefiniteness: A study in reference and grammaticality prediction*. London: Croon Helm.
- Hawkins, John A. 1991. On (in)definite articles: Implicatures and (un)grammaticality prediction. *Journal of Linguistics* 27: 405-442.

- Heim, Irene. 1991. Artikel und Definitheit. In: *Semantik: Ein internationales Handbuch der zeitgenössischen Forschung*, ed. Arnim von Stechow and Dieter Wunderlich, 487-535. Berlin: Walter de Gruyter.
- Hirschberg, Julia Bell. 1985. *A theory of scalar implicature*. Ph.D. dissertation, University of Pennsylvania.
- Horn, Laurence R. 1972. *On the semantic properties of logical operators in English*. Ph.D. dissertation, UCLA.
- Horn, Laurence R. 2001[1989]. *A natural history of negation*. Stanford, CA: CSLI Publications.
- Horn, Laurence R. and Barbara Abbott. 2014. <the,a>: (In)definiteness and implicature. In: *Reference and referring*, ed. William P. Kabasenche and Mmichael O'Rourke, 325-355. Cambridge, MA: MIT Press.
- Kratzer, Angelika. 1998. Scope or pseudoscope: Are there wide-scope indefinites? In: *Events and grammar*, ed. S. Rothstein, 163-196. Kluwer.
- Lauer, Sven. 2016. On the status of 'Maximize Presupposition'. In: *Proceedings of SALT 26*, ed. M. Moroney, C.-R. Little, J. Collard, and D. Burgdorf, 980-1001. Linguistic Society of America.
- Leahy, Brian. 2016. On presuppositional implicatures. *Topoi* 35: 83-91.
- Marciano, Dolores. n.d. *Mannge' na alaguan kalamasa*. National Dissemination and Assessment Center, CSULA.
- Matthewson, Lisa. 1999. On the interpretation of wide-scope indefinites. *Natural Language Semantics* 7: 79-134.
- Mithun, Marianne. 1984. The evolution of noun incorporation. *Language* 60: 847-894.
- Partee, Barbara H. 1987. Noun phrase interpretation and type-shifting principles. In: *Studies in Discourse Representation Theory and the theory of generalized quantifiers*, ed. J. Groenendijk, D. de Jongh, and M. Stokhof, 115-143. Dordrecht: Foris.
- Percus, Orin. 2006. Antipresuppositions. In: *Theoretical and empirical studies of reference and anaphora: Toward the establishment of generative grammar as an empirical science*. Report of the Grant-in-Aid for Scientific Research (B), Project No. 15320052, Japan Society for the Promotion of Science, 52-73.
- Reinhart, Tanya. 1997. Quantifier scope: How labor is divided between QR and choice functions. *Linguistics and Philosophy* 20: 335-397.
- Roberts, Craige. 2003. Uniqueness in definite noun phrases. *Linguistics and Philosophy* 26: 287-350.
- Sauerland, Uli. 2003. A new semantics for number. In: *Proceedings of SALT 13*, ed. R.P. Young and Y. Zhou, 258-275. Linguistic Society of America.
- Sauerland, Uli. 2008. Implicated presuppositions. In: *The discourse potential of underspecified structures*, ed. Anita Steube, 581-600. Berlin: Mouton de Gruyter.
- Schlenker, Philippe. 2012. Maximize Presupposition and Gricean reasoning. *Natural Language Semantics* 20: 391-429.
- Singh, Raj. 2011. "Maximize Presupposition!" and local contexts. *Natural Language Semantics* 19: 149-168.

- Van Geenhoven, Veerle. 1998. Semantic incorporation and indefinite descriptions. Stanford, CA: CSLI.
- Vikner, Carl and Per Anker Jensen. 2002. A semantic analysis of the English genitive. Interaction of lexical and formal semantics. *Studia Linguistica* 56: 191-226.
- Winter, Yoad. 1997. Choice functions and the scopal semantics of indefinites. *Linguistics and Philosophy* 20: 399-467.
- _____. Database (unedited) for the Revised Chamorro-English Dictionary. [CD]
- _____. Nuevo Testamento [the Chamorro New Testament]. Saipan, CNMI: Diocese of Chalan Kanoa. [NT]

Irish Questions are Relative*

Cathal Doherty S.J.
University of San Francisco

This paper is an exercise in the descriptive syntax of Irish. Of course, there is no such thing as pure description in linguistics, and every attempt to talk about the syntax of a language in a coherent way necessitates analytical choices using available conceptual apparatus. Having made a transition from theoretical linguistics to theology, I am sometimes asked if I see any continuity between what on the surface appear to be two radically different fields. In fact, I do see continuity in both the methodology and the object of study—Western theology distinguishes between ‘apophatic’ and ‘kataphatic’ statements about the divine—the former by means of negative statements about what the divine is not, the latter by means of positive statements. Theoretical syntax in the Chomskyan paradigm also makes its apophatic and kataphatic statements and moreover, about something that also transcends immanent human apprehension—linguistic competence, in describing what it is not, by means of negative statements about what lies outside it, as well as in positive descriptions of what lies within grammatical competence.

While this paper does not use the Irish facts to advance any particular theoretical analysis, it is not ‘agnostic’ with regard to theory. Rather, it aims to complement Jim’s standard approach to Irish unbounded dependencies (McCloskey 1977; 1990; 2001; 2008), exploring a line of inquiry that he briefly indicates in his early work (McCloskey, 1979). Our starting point is a set of syntactic constructions which are recalcitrant from this standard perspective. In the alternative description laid out here, however, these patterns, rather than proving exceptional, arguably reveal evidence for a real relative pronoun in the language.

Pushed to its logical conclusion, this line of inquiry favors a symbiotic relation between relative and interrogative syntax in the language, according to which interrogatives are formed by the same syntactic apparatus as relative clauses. This program of research, problematic in earlier versions of theoretical syntax as it seems to entail a mismatch of syntactic category and root clause, is perhaps less troublesome for current approaches (e.g. Adger and Ramchand, 2005).

*I would like to thank the staff of the Jesuit library, Milltown Park, Dublin for their help in accessing materials from the Irish collection.

1 IRISH RELATIVIZATION

The traditional description of Irish relative constructions, as for example in O’Nolan (1919) who admits that “the whole matter is somewhat complicated”, envisages two basic strategies: one used when the relativization site is subject or direct object, the other for oblique positions. These are the so-called ‘direct’ and ‘indirect’ strategies, the former involving a gap, the latter a resumptive pronoun:¹

- | | | |
|-----|--|--|
| (1) | ‘Direct relative’ | [NP [<i>a^L</i> . . . gap]] |
| | a. an fear a bhí _ anseo inné
<i>the man a^L was here yesterday</i>
‘the man who/that was here yesterday’ | |
| | b. an fear a chonaic tú _
<i>the man a^L saw you</i>
‘the man you saw’ | |
| (2) | ‘Indirect relative’ | [NP [<i>a^N</i> . . . <i>pro</i>]] |
| | a. an fear a raibh tú ag caint leis inné
<i>the man a^N were you talking to.him yesterday</i>
‘the man who/that you were talking to yesterday’ | |
| | b. an fear ar bhuail tú leis _ inné
<i>the man a^{N.PAST} struck you with.him yesterday</i>
‘the man you met yesterday’ | |

In Jim’s standard analysis of the facts, these unbounded dependencies are distinguished by syntactic movement: the direct strategy involves cyclic movement (of a null operator) while the indirect strategy with the resumptive pronoun is not movement-derived. Moreover, the particles *a^L* (followed by the morphosyntactic phenomenon of ‘lenition’) and *a^N* (followed by ‘eclipsis’) are taken to be purely functional elements with no lexical content, i.e. complementizer heads, rather than relative pronouns of any kind (McCloskey 2001, Sells 1984).² Nonetheless, three commonplace constructions are not consistent with this opposition between direct and indirect strategies. These are not peripheral constructions either, but arguably part of the core grammar of Irish. They include the ‘headless’ or ‘amount’ relative, as well as prepositional and adverbial relatives. In all of these, *a^N* appears with a gap rather than a resumptive pronoun:

- | | | |
|-----|---|--------------------------|
| (3) | D’ith mé [a raibh _ ann.]
<i>ate I a^N was there</i>
‘I ate all that was there.’ | <i>Headless Relative</i> |
|-----|---|--------------------------|

¹See O’Nolan (1919, 88-89).

²There is dialectal variation in the realization of the direct and indirect particles. For example, the direct particle may also take the form of *do^L* or a *dh^L* (before vowels). It may also be phonetically null, encoded only by lenition on the following verb, and/or by a special relative verbal form. The indirect particle may also have the form of the regular subordinating complementizer *go^N* (that). See O’Nolan (1919, 88-89).

- (4) an fear [lena raibh tú ag caint _] *Prepositional Relative*
the man with.a^N was you talking.PROG
 ‘the man with whom you were talking’
- (5) an áit [a raibh mé _] *Adverbial Relative*
the place a^N was I
 ‘the place where I was’

It is not easy to see how these constructions can be understood in a model of Irish syntax that upholds an absolute opposition between the direct and indirect relativization strategies, (1) and (2) above. One way out of the impasse, however, is if the particle *a^N* is not in fact a purely functional element here, but has pronominal content, as the native traditional grammatical tradition suggests in various places (e.g. Ó Cadhlaigh 1940, 359; 383). Let us now examine these constructions in turn.

2 ‘HEADLESS’ OR ‘AMOUNT’ RELATIVES

Notably, in the ‘headless’ or ‘amount’ relative, only a gap may appear in the relativization site.³

The resumptive strategy is absolutely unavailable, either in subject, direct object or oblique positions:

- (6) a. * a bhfaca **siad** ann é
a^N saw they there him
 ‘all who saw him there’
- b. * ar ith mé **é**
a^N.PAST ate I it
 ‘all I ate’
- c. * ar bhuail mé **leofa**
a^N.PAST struck me with.them
 ‘everyone that I met’

This construction is puzzling given that it appears to have purely clausal syntax and yet has the properties, both semantic and syntactic, of a nominal. Note how headless relatives appear in all canonical nominal positions: subject (both finite and nonfinite clauses), direct object, prepositional object and genitive:

Subject:

- (7) Níor tháinig [_{NP} a raibh le teacht.] (RG 126)
NEG.PAST came a^N was to.come
 ‘All those who were to come didn’t come.’

³This construction is also referred to as the ‘compound relative’ in some traditional grammars, e.g. (Christian Brothers 1919, 91; 1977, 145; Ó Catháin 1922, 171; O’Nolan 1919, 89).

- (8) Is leat [NP a bhfuil agam.] (NG 145)
 COP.PRES with.you a^N is at.me
 ‘Whatever’s mine is yours.’
- (9) Níor mhaith liom [[NP a dtáinig arais] imeacht arís.]
 NEG.COND good with.me a^N came back leave.INF again
 ‘I wouldn’t like those who came back to leave again.’

Object:

- (10) Cruinnigh [NP ar thuit d’ubhlaí] ar an chasán. (OS 134)
 gather a^N fell of.apples on the footpath
 ‘Gather all the apples that fell on the footpath.’
- (11) Ní dhéanfainn sin ar [NP a bhfaca mé ariamh.] (MM 20)
 NEG I.would.do that for a^N saw me ever
 ‘I would not do that for all I ever saw.’
- (12) D’ólamar [NP a bhfuairamar.] (GB 270)
 drank.IPL a^N got.IPL
 ‘We drank whatever we got.’

Prepositional object:

- (13) Tabhair sin chuig [NP a bhfuil beo de mo bhunadh.] (OS 134)
 give that to a^N are alive of my people
 ‘Give that to all of my people who are living.’
- (14) Agus d’éirigh sé i ndiaidh [NP a ndúirt an dochtúir.] (OS 134)
 and rose he after a^N said the doctor
 ‘And he rose after all the doctor said.’
- (15) Tháinig smúid ar [NP a rabh sa teach.] (OS 134)
 came gloom on a^N was in.the house
 ‘Gloom descended on all who were in the house.’

Genitive:

- (16) Níl [NP leath [ar imthigh i mbliana]] ag obair. (OS 134)
 NEG.be half a^N.PAST went this year working.PROG
 ‘Half of all who went this year aren’t working.’
- (17) Is leat [NP iomlán [a bhfeiceann tú.]] (OS 134)
 COP.PRES with.you entirety a^N see you
 ‘All that you see is yours.’
- (18) Bhí súile [NP a raibh de dhaoine sa tsinagóg] dlúite air (OC 384)
 Were eyes a^N were of people in.the synagogue fixed on.him
 ‘The eyes of all in the synagogue were fixed on him.’

This is all the more curious given that the headless relative particle a^N is syntactically and morphologically non-distinct from the a^N particle which appears in the indirect relative construction, (2) above. No morphological or syntactic property obviously distinguishes them. Note that as part of the verbal complex, a^N can never separate from the verb, even in co-ordinate structures:

- (19) a. an fear **ar ith agus ar ól** tú a chuid bia agus dí
the man a^N .PAST ate and a^N .PAST ate you his portion food and drink
 ‘the man whose food and drink you ate and drank’
 b. * an fear **ar ith agus ól** tú a chuid

In headless relative constructions, we see exactly the same behavior:

- (20) a. Sin [_{NP} **ar ith agus ar ól** sé.]
that's a^N .PAST ate and a^N .PAST drank he
 ‘That’s all he ate and drank.’
 b. * Sin [_{NP} **ar ith agus ól** sé.]

Moreover, both constructions display identical morphosyntactic alternations in the preverbal complex in the distinction between past and nonpast:

- (21) a. an fear a bhfuil a mhac tinn
the man a^N .NONPAST is his son sick
 ‘the man whose son is sick’
 b. Sin [_{NP} a bhfuil aige.]
that's a^N .NONPAST is.DEP at.him
 ‘That’s all he has.’
- (22) a. an rud a raibh tú ag caint faoi
the thing a^N .PAST was.DEP you talking about.it
 ‘the thing that you were talking about’
 b. Sin [_{NP} a raibh aige.]
that's a^N .PAST was.DEP at.him
 ‘That’s all he had.’
- (23) a. [_{NP} an rud [a mbéidh tú ag caint faoi amárach]]
the thing a^N .NONPAST be.FUT you talking about.it tomorrow
 ‘the thing that you will be talking about tomorrow’
 b. Sin [_{NP} a mbéidh fágtha den airgead.]
that's a^N .NONPAST be.FUT left of.the money
 ‘That’s what will be left of the money.’

What is more, a^N fuses with the copula in an identical fashion in both constructions:

- (24) a. an fear [_{CP} *ar* cuimhin leis sin]
the man a^N.COP memory with.him that
 ‘the man who remembers that’
- b. Sin [_{NP} *ar* cuimhin leis]
that’s a^N.COP memory with.him
 ‘That’s all he remembers.’
- (25) a. an fear [_{CP} *arbh* eol dó a luach féin]
the man a^N.COP.PAST knowledge to.him his worth own
 ‘the man who knew his own worth’
- b. Sin [_{NP} *arbh* eol dó.] (GB 270)
that’s a^N.COP.PAST knowledge to.him
 ‘That’s all he knew.’

Moreover, note that the particle *a^N* is obligatorily absent from relative clauses in which negation is encoded by the preverbal negative particle *nach*:

- (26) an bhean_x nach raibh tú ag caint léi_x
the woman NEG was you talking to.her
 ‘the woman who you weren’t talking to’

Strikingly, the particle *a^N* of headless relatives is also incompatible with the independent expression of negation. Instead, the clause must be given an overt nominal head:

- (27) a. * [_{NP} nach raibh _ agam]
NEG was at.me
 ‘All/What I didn’t have.’
- b. an méid nach raibh _ agam
the amount NEG was at.me
 ‘the amount/what I didn’t have’

In sum, the morphosyntactic parallels between the *a^N* particle of headless or amount relatives and that of other relatives are overwhelming, which strongly suggests the conclusion that headless relatives contain nothing more than purely clausal syntax.

That said, there is a problem that finds no resolution under the assumption that *a^N* is a purely functional particle in these constructions. How is it that these constructions mean what they mean? What is the source of the universal quantification they express? As an illustration, note the contrast between the two following sentences. The first example is a direct relative, the second is the headless or amount relative construction:

- (28) a. Sin [_{CP} a chonaic mé _]. *Direct relative*
that’s a^t saw I
 ‘That’s what I saw.’

- b. Sin [_{NP} a bhfaca mé _]. Headless relative
that's a^N saw I
 ‘That’s all I saw.’

To further illustrate the problem, note that these clauses often contain modifiers typical of universal quantification, such as partitive expressions beginning with *de* (of) and the postnominal modifier *eile* (other):

- (29) i ndiaidh [a raibh sé a dhéanamh _ de ghuíodóireacht] (GB 310)
after a^N was he doing of praying
 ‘after all the praying he was doing’
- (30) I measc [a raibh _ eile ann] bhí Seán ann. (GB 310)
among a^N was other there was Seán there
 ‘Amongst all the others who were, there was Seán’

To these, we can add examples with the prenominal determiners *gach* (all / every), *gach de* (all of), *iomlán* (entirety) and *leath* (half) in initial position:

- (31) Díol [gach [a bhfuil agat]]. (GB 310)
sell all a^N is at.you
 ‘Sell all you have.’
- (32) Thuigfinn [gach [a mbeadh sé ag cur síos air]]. (GB 310)
I.would.understand all a^N would.be he putting down on.it
 ‘I would understand all that he would be describing.’
- (33) D’éist siad le [gach [dá ndúirt sé]].
listened they to all of.a^N said he
 ‘They listened to all that he said.’
- (34) Níl [leath [ar imthigh i mbliana ag obair]]. (OS 134)
NEG.is half a^N.PAST went this year working
 ‘Half of those who went this year are not working.’
- (35) Is leat [iomlán [a bhfeiceann tú]]. (OS 134)
COP with.you entirety a^N see you
 ‘All you see is yours.’

If *a^N* is a purely functional element here, then how is the universal quantification encoded? Several analyses of headless relatives in earlier versions of syntactic theory entertained the hypothesis of a null pronominal *pro* as the head of the headless relative clause (e.g. Hirschbühler and Rivero 1983). Following the native grammatical tradition, however, the most obvious and least costly candidate is the *a^N* particle itself—if we understand it as a nasalizing proclitic relative pronoun, forming a morphosyntactic complex with the other elements of the Irish preverbal complex. According to some scholars, this nasalizing pronominal has its origin in the neuter article of Old Irish (Ó Searcaigh 1939, 133) as attested in the Old Irish glosses (eighth century):

- (36) a n-asbiur Wb. 17d12
a^N I.say
 ‘what I say’
- (37) Dénid anasberat frib Wb. 25c17
Do a^N say.they to.you
 ‘Do whatever they say to you.’
- (38) Arbeir biuth a mbís for altóir ind ídil Wb. 10c6
eats food a^N is on altar the idol
 ‘He eats what food is on the altar of the idol.’

Whatever its diachronic origins, the description of *a^N* in Modern Irish headless relatives as being or containing a pronominal is entirely compatible with all the morphosyntactic facts outlined above. As a proclitic, it simply fuses with the other elements of the preverbal complex, including tense particles and copula in the same way as other preverbal particles.

Moreover, there is nothing *a priori* alien to the syntax of Irish about a nasalizing pronominal, albeit functioning as a relative pronoun. Note that nasalization is lexically-specified in the Irish pronominal system: e.g., the distinction between third singular masculine possessive and third plural possessive is carried by the presence of nasalization in the latter (*a^L* ‘his’ vs. *a^N* ‘their’).

Other morphosyntactic variations also corroborate this general approach. Note how, in Irish, an intrusive nasal appears with certain prepositions in the third person before the possessive proclitic pronoun *a*:

- (39) a. ó Mháire ‘from Máire’
 b. ó Albain ‘from Scotland’
 c. **óna** mac ‘from her son’
- (40) a. le Máire ‘with Máire’
 b. le ord mór ‘with a sledgehammer’
 c. **lena** mac ‘with her son’

In the headless or amount relative construction, we find exactly the same morphosyntactic variation:

- (41) Sílim **óna** gcuala mé indiu go mbéidh cogadh ann. (OS 134)
I.think from.a^N heard I today that will.be war in.it
 ‘I think from what/all I heard today that there will be a war.’
- (42) Labhair sé **lena** raibh ann. (CG 78)
poke I with.a^N was in.it
 ‘He spoke with whoever was there.’

Again, these facts are unexceptional if we take the particle *a^N* in the headless relative construction to be a morphosyntactic amalgam of a nasalizing proclitic relative pronoun with the functional elements of the preverbal complex.

3 PREPOSITIONAL RELATIVES

Now consider the second recalcitrant construction, in which a preposition and the particle *a^N* fuse in the preverbal complex, corresponding to a gap in the relativization site:

- (43) an siopa **inar** cheannaigh mé milseáin _ . (RG 123)
the shop in.a^N bought I sweets
 ‘the shop in which I bought sweets’
- (44) an té **dá n-**oireann an caipín _ . (RG 123)
the one to.a^N suits the cap
 ‘the one who the cap fits’
- (45) Seo an capall **ar a** dtug mé fiche punta _ . (OS 117)
this’s the horse on a^N gave I twenty pounds
 ‘This is the horse for which I paid twenty pounds.’
- (46) cibé tír **as a** dtáinig sé _ (OS 118)
whatever country from a^N came he
 ‘whatever country he came from’

This construction bears some obvious similarities to pied-piping. In any case, the particle *a^N* here seems to be pronominal, inasmuch as it appears to be a prepositional complement. Morphosyntactic evidence also corroborates this description since an intrusive nasal appears with certain prepositions as expected:

- (47) an buachaill **óna** bhfuair mé an t-airgead _ . (RG 123)
the boy from.a^N got I the money
 ‘the boy from whom I got the money’
- (48) an peann **lena** scríobhfaidh mé an litir _ . (RG 123)
the pen with.a^N will.write I the letter
 ‘the pen with which I will write the letter’

Finally, note that as with headless relatives, a resumptive pronoun is excluded from this construction, and a gap is obligatory:⁴

- (49) * an peann **lena** scríobhfaidh mé an litir **leis**.
the pen with.a^N will.write I the letter
 ‘the pen with which I will write the letter’

⁴Ó Cadhlaigh (1940, 390) notes examples from the works of the literary figure Séathrún Céitinn (17th century) in which the structure in (49) is attested. These are not found anywhere in the contemporary language, however, to my knowledge.

4 ADVERBIAL RELATIVES

Relative clauses formed on bare-NP adverbs of time, reason, manner and place also display the anomalous pattern in which *a^N* appears with a gap rather than a resumptive pronoun:

Time:

- (50) Is cuimhin liom an t-am (lá, oíche, etc.) ar gabhadh é. (GB 307)
COP memory with.me the time (day, night, etc.) a^N.PAST arrested him
 ‘I remember the time (day, night etc.) he was arrested.’
- (51) Tiocfaidh an lá a mbéimid uilig aosta ... (OS 127)
will.come the day a^N will.be.PL all old
 ‘The day will come when we will all be old.’

Manner / Reason:

- (52) Cad é an dóigh arb orthusan an locht? (GB 307)
what 3SG the way COP.a^N.PAST on.3PL.EMPH the blame
 ‘How is the blame on them?’
- (53) Sin an fáth ar chuir mé Tomás chugat ... (OS 127)
that's the reason a^N.PAST put I Tomás to.you
 ‘That’s the reason I sent Tomás to you.’

Place:

- (54) Sin an áit a bhfuil an cheist. (GB 307)
that.COP the place a^N is the question
 ‘That’s where the question is.’
- (55) Rachamuid ar a lorg an bealach a dteachaidh sí ... (OS 127)
will.go.1SG on her search the road a^N went she
 ‘We will go looking for her in the direction she went’

Are we dealing with a relative pronoun in this construction also? Note the contrast between the following examples (O’Nolan 1919, 90), which is suggestive of some lexical content in the *a^N* particle:

- (56) a. Fan mar atá tú.
stay as a^L.are you
 ‘Stay as you are.’
- b. Fan mar a bhfuil tú. (RG 316)
stay as a^N are you
 ‘Stay where you are.’

Such examples are at least consistent with the description of a^N as being or containing a nasalizing relative pronoun. Otherwise, we have to lexically specify in some way that these nominal adverbs demand a^N rather than the regular direct relative construction with a^L .

Finally, note as with the other two constructions discussed above, the use of a gap is obligatory in these adverbial relatives and a bare pronominal cannot resume the bare-NP head:

- (57) * an áit a raibh tú **é/i**
the place a^N were you it
 ‘the place where you were’

Occasionally, however, it seems that a resumptive may be used if the relativization site is in an oblique position, such as the object of a preposition, as with many bare-NP adverbs of place:

- (58) an áit a raibh tú ann
the place a^N were you in.it
 ‘the place where you were’

These examples, I believe, yield to description as regular restrictive relatives formed on the nominal adverb, however. Note that the prepositional relative construction can also be formed on such nominals:

- (59) an áit ina raibh sé _
the place in. a^N was he
 ‘the place he was’

5 A^N AS RELATIVE PRONOUN

It seems plausible, therefore, to draw the conclusion that a^N is, in at least in some cases, a relative pronoun, such as in these constructions in which it appears with a gap rather than a resumptive pronoun. Yet this particle, as we have seen, is indistinguishable in every way from the a^N particle of indirect relatives. Let us entertain the strongest possible hypothesis, therefore— a^N is in all cases a relative pronoun in Irish, even in the indirect relative construction. The major analytical task then becomes the accurate distribution of resumptive pronouns and gaps in the relative system. Recall from (2) above that resumptives are excluded from the subject position, a fact often attributed to the ‘Highest Subject Restriction’ (e.g. McCloskey 1990, 210):

- (60) * an fear a raibh **sé** tinn
the man a^N was he sick
 ‘the man who was sick’

Resumptives are, however, acceptable in direct object positions, as well as in oblique positions such as prepositional complement.⁵

In setting loose a relative pronoun a^N in the grammatical system, we would also need to exclude all structures in which it cannot appear with a gap, whether in subject, direct object as well as prepositional object positions:

- (61) * an fear a raibh _ tinn
the man a^N was sick
 ‘the man who was ill’
- (62) * an fear ar bhuail tú _
the man a^N .PAST struck you
 ‘the man you struck’
- (63) * an fear ar bhuail tú le _
the man a^N .PAST struck you with
 ‘the man you met’

In addition, we need to explain why this same relative pronoun a^N requires a gap rather than a resumptive in the three ‘exceptional’ constructions we just described. All this is no mean task, but let us see how far we can go.

5.1 RECASTING THE DIRECT AND INDIRECT RELATIVE STRATEGIES

A curious asymmetry is present in the traditional opposition between direct and indirect relative strategies, outlined in (1) and (2) above, in that the direct object position accepts resumptives. Otherwise, it would be possible to maintain that resumptives are restricted to oblique positions in Irish. For this reason, the phenomenon of ‘pronoun postposing’, the obligatory displacement of accusative pronouns in Irish to a right-peripheral position (Chung and McCloskey 1987, 194; Bennett, Elfner and McCloskey 2016) may provide a key to understand the possibility of resumptives in apparent direct object position:

- (64) Chonaic mé _ ansin inné í.
saw I there yesterday her
 ‘I saw her there yesterday.’

Pronoun postposing cannot occur with nominative pronouns, however, which are enclitic to the verb and can never be separated from the verbal complex.

Let us assume, therefore, that accusative pronouns in Irish are not in fact in direct object position at all, but are postposed and so appear in an oblique position:

- (65) All direct object pronouns in Irish are ‘postposed’ to an oblique position

⁵Given the VSO order of Irish, potential syntactic ambiguity arises in subject and direct object relativization. Traditional grammars point to the possibility of a resumptive pronoun in direct object position as a strategy to avoid such ambiguities. See Ó Cadhlaigh (1940, 376) also McCloskey (1977).

This allows us maintain the generalization (66) below:

- (66) Resumptives appear only in oblique positions in Irish.

Under this description of the facts, the acceptability of accusative resumptives in putative direct object position and the exclusion of nominative resumptives from subject position follows directly, without appeal to any independent considerations such as a Highest Subject Constraint. Moreover, the traditional distinction between direct and indirect relatives, (1) and (2) above, can now be restated in simpler and cleaner terms: the direct relative is for argument positions, the indirect relative for oblique positions only (including postposed direct object pronouns).

Finally, the question arises as to why it is a^N that must appear with resumptives, rather than a^L , and not the other way round? Under the standard analysis, in which both are complementizers, there is no obvious explanation. The strong hypothesis considered here may provide the foundation for an answer, however—if a^N itself is pronominal or has pronominal content, the fact that the resumptive strategy requires a^N rather than a^L is perhaps less surprising, if a^N functions as a pronominal syntactic operator and local antecedent for the resumptive.

5.2 DISTRIBUTION OF A^N AND RESUMPTIVE PRONOUNS

The key to predicting the distribution of the remaining patterns, I believe, under this strong hypothesis, lies in the semantics of pronominal a^N itself, in what it can and cannot refer to, as well as in the semantics of resumptive pronouns in the language in general. Nothing *a priori* excludes the pattern in which a^N appears with a gap in the relativization site, under the strong hypothesis that a^N is a relative pronoun. The constraints on this pattern must result from independent considerations and these plausibly include the conditions on pronominal reference in the language.

In particular, if we assume that relative pronoun a^N is underspecified in reference for person and number and cannot therefore bind a referential argument in itself, then the impossibility of a^N binding a gap in argument positions, (61)-(63) above, follows:

- (67) * NP_x [a^N _x [V _{-x}]]

On the other hand, the absolute impossibility of resumptives in headless relatives, (6) above, also requires explanation. Could it be for some reason that resumptives cannot function as variables bound by a universal quantifier in the language? This seems untenable—resumptives bound by universal quantifiers are attested when the relativization site is an oblique position (indirect strategy):

- (68) Bhídís i ngach uile theach dá dtéimis go dtí é. (GB 310)
they.were in every entire house to.a^N we.would.go to it
 ‘They were in every house that we would go to.’

It would seem more likely that a bound pronominal requires an overt antecedent in order to be interpretable and in the case of headless relatives, the proclitic pronominal a^N cannot in itself provide such an antecedent. This is far from an explicit analysis, but it is clear that syntax alone cannot bear the explanatory burden for the absence of pronominal resumptives from this construction, under the strong hypothesis. Rather, conditions on pronominal reference may be a source of explanation for this phenomenon. A corroborating observation is that the nominal *méid* (amount) cannot be resumed by a pronominal:

- (69) * an méid ar ól sé é
the amount a^N.PAST drank he it
 ‘the amount he drank’ / ‘all he drank’ / ‘what he drank’

Again, this is consistent with conditions on pronominal reference as the root explanation for the exclusion of resumptives from headless relatives. Similar considerations extend to the adverbial relatives: if bare-NP adverbs cannot function as adequate antecedents to resumptives in an argument position, (57) above.

Finally, in the case of prepositional relatives which, as we saw, arguably reduce to a form of ‘Pied-Piping’ or *wh*-movement of a prepositional element, again we expect a gap rather than a resumptive pronoun, since the relativization site is prepositional and not nominal.

- (70) * an fear lena raibh tú ag caint é
the man with.a^N were you talking him
 ‘the man you were talking to’

That is to say, in this construction a^N does not directly enter into an unbounded dependency with a referential nominal, which we have previously claimed to be impossible. Rather, an inflected preposition (*lena*, ‘with-*wh*’) is in an unbounded dependency with a prepositional phrase gap in the relativization site. In other words, in this construction, we are dealing with an inflected prepositional head (*lena^N*) creating an unsaturated verbal complex, rather than a pronominal (a^N) functioning as relative operator.

6 CONCLUSIONS

As stated at the outset, the goal of this short paper is enlightened description, rather than the promotion of a particular analysis supported by the Irish facts. We have seen that there is some evidence that a^N is a relative pronoun in Irish, following the suggestions of the native grammatical tradition. We then considered the analytical task entailed by the strong hypothesis that the particle a^N is a generally a relative operator in Irish, concluding that constraints on pronominal reference may partly explain the alternations between gaps and resumptives, in tandem with the observation that all pronominal objects are in an oblique (post-posed) position in the language.

Ineluctably, the question of interrogative syntax arises, however, since here we witness the same opposition between direct and indirect strategies in questions as relative clauses:

- (71) a. Cé_x a bhí _{-x} anseo inné Direct
who a^L was here yesterday
 ‘Who was here yesterday?’
- b. Cén fear_x a raibh tú ag caint leis_x inné Indirect
which man a^N were you talking to.him yesterday
 ‘Which man were you talking to yesterday?’

The standard analysis is that these facts are incompatible with the status of the preverbal particles *a^L* and *a^N* as pronominals. Instead, the conclusion is that they must be purely functional, complementizers. The native grammatical tradition, which of course does not distinguish between relative pronouns and complementizers, by contrast, often presents interrogatives and relatives as having parallel syntax and even refers to the preverbal particles as relative pronouns.⁶ Could it be the case that interrogative syntax in Irish in fact reduces to relative syntax?

If we widen our perspective to the extraction of prepositional elements, we again observe the anomalous pattern, under the standard analysis at least, in which *a^N* binds a gap instead of a resumptive:

- (72) a. [Cé leis] a raibh tú ag caint _? (OS 104)
who with.him a^N were you talking
 ‘Who were you talking to?’
- b. [Cé dó] a dtug tú an litir _? (OS 104)
who to.him a^N gave you the letter
 ‘Who did you give the letter to?’
- c. [Ca hair] a raibh sibh ag caint _? (OS 104)
what on.it a^N were you.pl talking
 ‘What were you talking about?’

In addition, in some dialects and registers at least, even if not usual in everyday speech, the following pattern is attested, which closely parallels the ‘prepositional relative’ examined above:

- d. [Cén fear] lena raibh tú ag caint _? (OC 389)
which man with.a^N were you talking
 ‘Which man were you talking with?’

Furthermore, note that with *wh*-extraction of adverbs, we find the same pattern as adverbial relatives and *a^N* binds a gap:

- (73) a. Cad chuige ar labhair tú _? (OS 103)
why a^N.PAST spoke you
 ‘Why did you speak?’

⁶Ó Searcaigh (1939, 108 par. 213).

- b. Cá gceannóchaidh tú na caoirigh _ ? (OS 105)
where.a^N will.buy you the sheep
 'Where will you buy the sheep?'⁷
- c. Goidé an t-am a dtáinig sé _ ? (OS 127)
what the time a^N came he
 'What time did he come?'

Now if Irish relatives and interrogatives reduce to the same fundamental syntactic structure, then the parallel alternation between direct and indirect patterns found in both constructions is entirely expected. Moreover, if *a^N* is a pronominal operator, as under the strongest hypothesis pursued here, then those interrogatives in which *a^N* appears with a gap rather than a resumptive also become regular, or at least less surprising, in parallel with their relative counterparts.

Finally, it is important to point to another pattern in the language in which relative syntax putatively functions as a clause, a cleft-like focus construction known as the 'independent' relative clause (*an clásal coibhmeasta leithleach*) in traditional grammars "for want of a better term."⁸ In this construction, an embedding copula is often missing, as below.

- (74) Ø Pádraig a bhí ann.
Patrick a^t was there
 'Patrick was there / It was Patrick who was there.'

The same traditional grammar categorizes regular interrogative sentences such as we have been considering in this essay as examples of the same 'independent relative' (focus) construction. Regardless of one's theoretical commitments, therefore, this construction is perhaps a key for better understanding Irish unbounded dependencies.

ABBREVIATIONS

- CG *Ceart na Gaeghilge*, Ó Cadhlaigh 1916.
 GB *Graiméar Gaeilge na mBráithre Críostaí*, Christian Brothers 1960.
 MM *Cora Cainte as Tír Chonaill*, Mac Maoláin 1943.
 NG *New Irish Grammar*, Christian Brothers 1977.
 OC *Gnás na Gaeilge*, Ó Cadhlaigh 1940.
 OS *Coimhréir Ghaedhilge an Tuaiscirt*, Ó Searcaigh 1939.
 RG *Réchúrsa Gramadaí*, Mac Giolla Phádraig 1963.

REFERENCES

- Adger, David and Gillian Ramchand. 2005. Merge and Move: *Wh*-Dependencies Revisited. *Linguistic Inquiry* 36. 161-193.

⁷The *wh*-word *cá* (where) here is plausibly fused with *a^N*. See Ó Searcaigh (1939, 105 n).

⁸See Christian Brothers (1999, 216ff) for a brief description of this construction.

- Bennett, Ryan, Emily Elfner and James McCloskey. 2016. Lightest to the Right: An Apparently Anomalous Displacement in Irish. *Linguistic Inquiry* 47. 169-234.
- Bresnan, Joan and Jane Grimshaw. 1978. The Syntax of Free Relatives in English. *Linguistic Inquiry* 9. 331-391.
- Christian Brothers. 1919. *Graiméar na Gaedhilge leis na Bráithreachaibh Críostamhla*. 6th edition. Dublin: M.H. Gill & Son.
- Christian Brothers. 1960. *Graiméar Gaeilge na mBráithre Críostaí*. Dublin: M.H. Mac an Ghoill agus a Mhac, Tta.
- Christian Brothers. 1962. *Nuachúrsa Gaeilge na mBráithre Críostaí*. Dublin: M.H. Mac an Ghoill agus a Mhac, Tta.
- Christian Brothers. 1977. *New Irish Grammar*. Dublin: Fallons.
- Christian Brothers. 1999. *Graiméar Gaeilge na mBráithre Críostaí*. Dublin: An Gúm.
- Chung, Sandra and James McCloskey. 1987. Government, Barriers, and Small Clauses in Modern Irish. *Linguistic Inquiry* 18. 173-237.
- Hirschbühler, Paul and María-Luisa Rivero. 1983. Remarks on Free Relatives and Matching Phenomena. *Linguistic Inquiry* 14. 505-520
- McCloskey, James. 1977. An Acceptable Ambiguity in Modern Irish. *Linguistic Inquiry* 8. 604-609
- McCloskey, James. 1979. *Transformational Syntax and Model Theoretic Semantics: a case-study in Modern Irish*. Dordrecht: Foris.
- McCloskey, James. 1990. Resumptive Pronouns, A-binding and Levels of Representation in Irish. In Randall Hendrick (ed.), *Syntax and Semantics 23: The Syntax of the Celtic Languages*, 199-248. London: Academic Press.
- McCloskey, James. 2001. On the morphosyntax of *wh*-movement in Irish. *Journal of Linguistics* 37. 67-100.
- McCloskey, James. 2008. Resumption, Successive Cyclicity, and the Locality of Operations. In Samuel Epstein & T.D. Seely (eds.), *Derivation and Explanation in the Minimalist Program*, 184-219. Hoboken, NJ: Wiley, 2008.
- Mac Giolla Phádraig, Brian. 1963. *Réchúrsa Gramadaí*. 3rd edition. Dublin: Longman Brún agus Ó Nualláin Teo.
- Mac Maoláin, Séán. 1943. *Cora Cainte as Tír Chonaill*. 3rd edition. Dublin: Oifig an tSoláthair.
- Ó Cadhlaigh, Cormac. 1916. *Ceart na Gaedhilge: Irish syntax*. Dublin: Mellifont.
- Ó Cadhlaigh, Cormac. 1940. *Gnás na Gaedhilge*. Dublin: Oifig an tSoláthair
- Ó Catháin, Seaghán. 1922. *Ceachta Cainte Gramadaigh: the practical Irish grammar*. Dublin: McGill.
- Ó Nolan, Gerald. 1919. *Studies in Modern Irish: Part 1*. Dublin: The Educational Company of Ireland Ltd.
- Ó Searcaigh, Séamus. 1939. *Coimhréir Ghaedhilg an Tuaiscirt*. Dublin: Oifig an tSoláthair.

On the interaction of head movement and ellipsis in Danish^{*}

Vera Gribanova
Stanford University

Line Mikkelsen
University of California, Berkeley

1 INTRODUCTION

A key question in investigations of elliptical processes concerns the nature of the ellipsis site, and its interaction with other syntactic processes. A priori, one can imagine two logical extremes. One extreme is the hypothesis of *COMPLETE OPACITY*, in which ellipsis blocks any and all syntactic processes from applying to material inside the ellipsis site. On the other end of the spectrum is the hypothesis of *TOTAL TRANSPARENCY*, in which ellipsis has no effect on syntactic processes whatsoever.

Existing work makes clear that the *COMPLETE OPACITY* hypothesis cannot be correct, since various kinds of movement operations may apply to an element inside the site of the ellipsis site (Merchant 2001: among others). In and of itself, this kind of evidence has been used to argue that constituent ellipsis involves syntactic structure that remains unpronounced (Ross 1969, Merchant 2001), rather than being a proform (Hardt 1993) and/or subject to semantic or pragmatic reconstruction (Ginzburg & Sag 2000, Culicover & Jackendoff 2005). Fairly straightforward examples involve *WH*-movement out of the ellipsis site (1) and *A*-movement — in this case, for passive — out of the ellipsis site (2).

^{*}For generous comments and feedback on the ideas presented here, we thank Emily Clem, Boris Harizanov, Peter Jenks, Jim McCloskey, Jason Merchant, and the audience of UC Berkeley's Syntax Circle. We would like to thank the editors of this volume for putting it together, for providing us with the opportunity to collaborate, and share our appreciation of Jim McCloskey's mentorship over the course of many years.

- (1) I know which puppy you SHOULD adopt, but I don't know which one you SHOULD'N'T. (Schuyler 2001: 1)

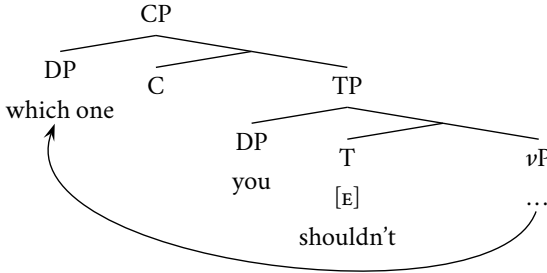

- (2) Mark wasn't invited, but I was.

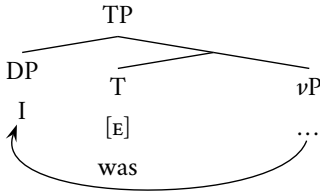

In this paper, we investigate a pattern that violates the expectation of transparency: in Danish, head movement is prohibited out of the ellipsis site, despite being permitted otherwise. Like other Mainland Scandinavian languages, Danish is a verb second language in non-embedded environments. Traditional accounts of this pattern (den Besten 1983, Vikner 1995) involve the movement of a phrasal element to [spec, C] and verb movement to C. Danish also permits VP ellipsis, stranding an auxiliary outside the VP ellipsis site. Despite the independent availability of both main verb movement to C and VP ellipsis, Danish prohibits the combined application of these operations: there is no main verb movement out of Danish VP ellipsis sites. Against the backdrop of the previous discussion, this prohibition represents a puzzle: there must be something special about one of these operations — or their interaction, as proposed by Sailor (To appear) — such that the main verb cannot be stranded outside of the ellipsis site in Danish.

Two obvious explanations for this pattern can be excluded at once. First, the pattern is not due to Danish VP ellipsis being generally opaque: Danish VP ellipsis is transparent to A-movement (3) and A-bar movement (4) in the same way English VP ellipsis is.

- (3) Jeg blev ikke inviteret. Blev du?
I became not invited became you
 'I was not invited. Were you?'
- (4) Jeg ved ikke hvad for en hund SUSAN har valgt, men jeg ved hvad
I know not what for a dog Susan has chosen but I know what
 for en MARIE har.
for one Marie has.
 'I don't know what kind of dog SUSAN has chosen, but I know what kind
 of dog MARIE has.'

Second, the pattern is also not due to VP ellipsis being crosslinguistically opaque for head movement: verb movement out of the site of VP ellipsis results in perfectly grammatical verb-stranding VP ellipsis configurations in a diverse set of languages, including Irish (McCloskey 1996, 2012, 2016), Russian (Gribanova 2013b,a, 2017, *To appear*), Hebrew (Goldberg 2005b,a), Greek (Merchant 2017), Hindi-Urdu (Manetta *To appear*, 2017), Hungarian (Lipták 2013), Swahili (Ngonyani 1996), Finnish (Holmberg 2001), European Portuguese (Santos 2009), and others.

Recent work by Aelbrecht (2010) and Sailor (*To appear*) has brought us closer to an explanation for the behavior of Danish verb movement under ellipsis. One part of the explanation is the idea, developed independently in Aelbrecht 2010, that an ellipsis site is closed off for syntactic processes when the licenser of the ellipsis is merged. The second part of the explanation is that verb movement in Danish verb second clauses is triggered by C, whereas the licenser of VP ellipsis is T (Sailor *To appear*: 11–12). Taken together with the idea that syntactic derivations proceed bottom-up, these commitments should result in a derivational blocking effect, whereby the trigger for verb movement (C) is merged only after the VP ellipsis licenser (T) is merged. Since the ellipsis licensing head makes the ellipsis site opaque to further operations, verb movement out of the ellipsis site is blocked.

What we demonstrate in this paper is that the aforementioned set of commitments yields only a partial explanation for the lack of verb-standing VP ellipsis in Danish. Citing evidence from Vikner 1995, Sailor (*To appear*) takes there to be no movement of V to T independent of V to C. But T and V nevertheless must be morphologically unified, in both main and embedded clauses. Although main verb stranding ellipsis is still prohibited in Danish embedded clauses, nothing about Aelbrecht's or Sailor's proposals prevents this from taking place. Under the standard view of head movement — *qua* syntactic movement and head adjunction — movement of V to T in the embedded clause, in combination with VP ellipsis, would yield exactly the prohibited effect. If, as Sailor (*To appear*) claims, there is no movement of V to T independent of V to C, then the question of how the main verb comes to bear tense inflection arises but receives no immediate answer.

The claim we put forth here is that Sailor's account is missing a crucial and independently argued for observation about the nature of head movement that comes from recent work by Harizanov & Gribanova (2018) (henceforth H&G). Their proposal is that the effects usually modeled by head movement actually fall into two distinct classes, with principally distinct properties: there is genuinely syntactic movement of heads on the one hand, and postsyntactic amalgamation of heads (for purely morphological purposes) on the other. Danish verb movement to C is, they claim, of the syntactic type, while amalgamation of V and T in embedded clauses is postsyntactic *Lowering* (Embick & Noyer 2001) and involves no syntactic operations. Once this observation is in place, both main clause and embedded clause behavior in Danish fall into place. A Danish verb never undergoes syntactic head movement below C, hence it can never escape VP ellipsis. Genuinely syntactic head movement of the verb to C in V₂ clauses is blocked by

the interaction of the Aelbrecht (2010) licensing schema and Sailor’s derivational timing proposal, as described above.

The resulting proposal wields a great deal of explanatory power. Beyond explaining the Danish-specific interaction between VP ellipsis and head movement, it can also explain crosslinguistic interactions between ellipsis and head movement: why does Danish lack verb-stranding ellipsis, but e.g. Irish, Russian, and Hebrew have it? This latter question, we claim, can be answered by considering the range of possibilities in postsyntactic amalgamation. While Danish verb unification involves *Lowering* of T to V, in languages that permit verb-stranding ellipsis, the amalgamation goes in the other direction — a postsyntactic operation H&G call *Raising*.

2 DANISH CLAUSE STRUCTURE AND VERB MOVEMENT

2.1 VERB MOVEMENT IN MAIN AND EMBEDDED CLAUSES

The signature feature of Danish main clauses is that the finite verb surfaces in second position, whether it is an auxiliary verb (5) or a main verb (6):

- (5) a. Mona **har** ikke vasket bilen.
Mona has not washed car.DEF
 ‘Mona has not washed the car.’
- b. Bilen **har** Mona ikke vasket.
car.DEF has Mona not washed
 ‘Mona hasn’t washed the car.’
- c. Hvorfor **har** Mona ikke vasket bilen?
why has Mona not washed car.DEF
 ‘Why hasn’t Mona washed the car?’
- (6) a. Mona **vasker** ikke bilen.
Mona washes not car.DEF
 ‘Mona doesn’t wash the car.’
- b. Bilen **vasker** Mona ikke.
car.DEF washes Mona not
 ‘Mona doesn’t wash the car.’
- c. Hvorfor **vasker** Mona ikke bilen?
why washes Mona not car.DEF
 ‘Why doesn’t Mona wash the car?’

This follows from the standard analysis of Germanic V2 (den Besten 1983, Vikner 1995): the finite verb moves to C via T and a phrasal constituent moves to [spec, CP]. In the (a) examples, that phrasal constituent is the subject, in the (b) examples it is the direct object, and in the (c) examples an adjunct WH-phrase. As seen in (5), non-finite verbs surface below negation, which indicates that they remain *in situ* inside the verb phrase.

In embedded clauses, there is no V2. Instead the finite verb surfaces below negation, as seen in the (a) examples. The (b) examples show the impossibility of V2 in this embedded environment and the (c) examples show that the finite verb cannot undergo short head movement across negation to T.

- (7) a. Jeg undrede mig over hvorfor Mona ikke **havde** vasket bilen.
I wondered REFL over why Mona not had washed car.DEF
 'I wondered why Mona had not washed the car.'
- b. *Jeg undrede mig over hvorfor **havde** Mona ikke vasket bilen.
I wondered REFL over why had Mona not washed car.DEF
- c. *Jeg undrede mig over hvorfor Mona **havde** ikke vasket bilen.
I wondered REFL over why Mona had not washed car.DEF
- (8) a. Jeg underede mig over hvorfor Mona ikke **vaskede** bilen.
I wondered REFL over why Mona not washed car.DEF
 'I wondered why Mona didn't wash the car.'
- b. *Jeg undrede mig over hvorfor **vaskede** Mona ikke bilen.
I wondered REFL over why washed Mona not car.DEF
- c. *Jeg undrede mig over hvorfor Mona **vaskede** ikke bilen.
I wondered REFL over why Mona washed not car.DEF

Thus the generalization is that there no head movement of V unless it moves all the way to C (as argued by Vikner (1995), among others).

2.2 DANISH VP ELLIPSIS

Possible VP ellipsis configurations in Danish include a stranded auxiliary (9), a stranded dummy auxiliary (10), but *not* a stranded main verb (11) or an unrealized tense head (12). The (a) examples show the relevant pattern in main clauses, while the (b) examples show the same pattern in embedded clauses.

- (9) a. Mona og Jasper har vasket bilen, eller rettere Mona har _____.
Mona and Jasper have washed car.DEF or rather Mona has
 'Mona and Jasper have washed the car, or rather Mona has.'
- b. Jeg har vasket bil, selvom Mona ikke har _____.
I have washed car even.though Mona not has
 'I have washed my car even though Mona hasn't (washed her car).'
- (10) a. Mona og Jasper vaskede bilen, eller rettere Mona gjorde _____.
Mona and Jasper washed car.DEF or rather Mona did
 'Mona and Jasper have washed the car, or rather Mona did.'
- b. Jeg vasker bil, selv hvis Mona ikke gør _____.
I wash car even if Mona not does
 'I wash my car even if Mona doesn't (wash her car).'

- (11) a. *Mona og Jasper vaskede bilen eller rettere Mona vaskede ____.
Mona and Jasper washed car or rather Mona washed
intended: 'Mona and Jasper washed the car, or rather Mona did.'
- b. *Jeg vasker bil, selv hvis Mona ikke vasker ____.
I wash car even if Mona not washes
- (12) a. *Mona og Jasper vaskede bilen eller rettere Mona ____.
Mona and Jasper washed car or rather Mona
intended: 'Mona and Jasper washed the car, or rather Mona did.'
- b. *Jeg vasker bil, selv hvis Mona ikke ____.
I wash car even if Mona not

The ungrammaticality of (12) is familiar from English. Tense must be expressed and if no regular verb is available to host tense, a dummy verb must be employed, as in (10). A Danish-specific puzzle is the lack of verb-stranding VP ellipsis in (11a). The VP targeted by ellipsis is in a main clause and thus the finite main verb *vaskede* is expected to move to C and thereby escape the ellipsis of VP. For some reason the combination of verb movement to C and VP ellipsis does not result in verb-stranding ellipsis. This is especially puzzling in light of the fact that analogous configurations, in which the main verb is stranded outside of an ellipsis site, are crosslinguistically common, e.g. in Irish:

- (13) a. Ar chuir tú isteach ar an phost?
INTERR-[PAST] put-[PAST] you in on the job
 'Did you apply for the job?'
- b. Chuir. / Níor chuir.
put-[PAST] / NEG-[PAST] put-[PAST]
 'Yes.' / 'No.'
- (McCloskey 2012)

In the next section we examine the solution to this puzzle put forth by Sailor (To appear). Sailor's key idea is that in V2 clauses, verb movement is triggered after VP ellipsis has been effectuated, and that this derivational timing is responsible for the lack of verb-standing VP ellipsis in Danish. We argue that this provides a partial explanation, but that more needs to be said to explain why there is no verb-stranding VP ellipsis in the absence of verb movement to C, as in (11b).

3 INTERACTIONS: ELLIPSIS LICENSING AND HEAD MOVEMENT

Sailor's starting point is the theory of ellipsis licensing developed by Aelbrecht 2010, which in turn relies heavily on Merchant 2001. According to Merchant, there is full syntactic structure in the ellipsis site, which is what allows syntactic processes like movement to interact with material in the ellipsis site. Ellipsis is effectuated by a feature [E] that resides on the licensor of the ellipsis. [E] manages

both the semantic side of ellipsis (the givenness requirement) and the phonological side: the sister of the head bearing [E] goes unpronounced. If nothing else constrains ellipsis, we expect the ellipsis site to be completely transparent for syntactic movement. Aelbrecht's main claim is that transparency is constrained by the derivational timing of ellipsis with movement processes that target elements inside the ellipsis site. At a certain point in the derivation, namely when the licenser of ellipsis has been Merged, material inside the ellipsis site becomes accessible for movement. Only movement that is triggered prior to or at this point may proceed out of the site of ellipsis.

Aelbrecht implements this derivational timing by separating the [E] feature from the licenser. In the case of English VP ellipsis, the licenser is T but the [E] feature resides on a lower head, namely Voice. For ease of reference we'll refer to the head carrying the [E] feature as the *HOST*. The target of ellipsis is the sister of the host, which is *vP* in the articulated clause structure assumed by Aelbrecht (2010: 175–176). Auxiliaries reside between T and Voice, and negation is left adjoined to the complement of T. External arguments are introduced in SpecVoice. The sister of the host remains transparent until the licenser is Merged. This defines the window of opportunity for syntactic extraction out of the ellipsis site. Applying these assumptions to Danish VP ellipsis, we have the structure in (14) for the auxiliary stranding case in (9).

(14) Danish VPE with aux-stranding à la Aelbrecht 2010:

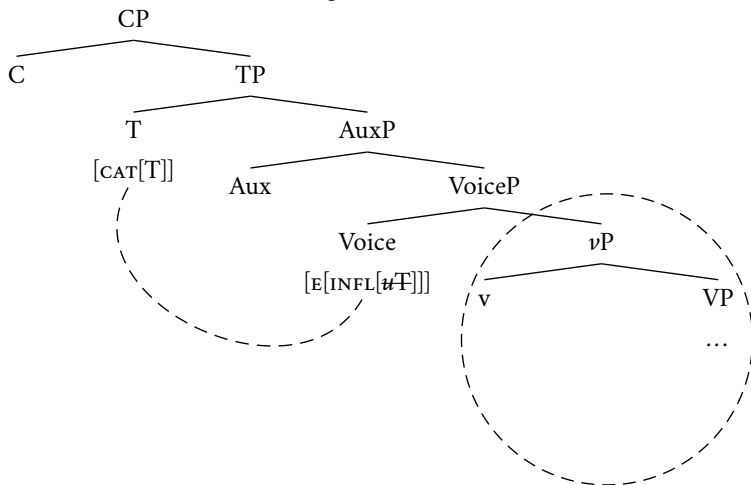

On this view, auxiliaries survive ellipsis because they are never inside the ellipsis site (*vP*). External arguments survive ellipsis because they are never inside the ellipsis site either; they are base-generated in [spec, Voice]. Internal arguments may escape VP ellipsis by A-movement to [spec, T] (passive/unaccusative) or by A-bar movement to the edge of the VoiceP phase.

Consider now an ellipsis derivation of a V2 clause without an auxiliary. If Danish verb movement to C proceeds through T and that first movement step is triggered when T is Merged, this set of assumptions predicts verb stranding VP

ellipsis, because T is the ellipsis licenser and any syntactic processes triggered by the licenser or a lower head are unaffected by ellipsis. The core insight of Sailor (To appear) is to connect the lack of verb-stranding VP ellipsis to the lack of independent verb movement to T. Recall from the discussion of embedded clauses in the previous section that in non-V₂ clauses, the finite verb doesn't move to T — it remains below negation. This suggests that the only trigger for verb movement in Danish is C, and that the verb moves directly from its base position to C. C is Merged after the ellipsis licenser (T) and thus unable to interact with material inside the ellipsis site, including the verb. This is Sailor's explanation for the lack of verb-stranding VP ellipsis in Danish V₂ clauses.

We don't question the logic of this explanation, but we believe it is incomplete in the following sense: if the verb moves directly to C in V₂ clauses, something else must be responsible for combining V and T and producing a finite verb. Ideally that would be the same mechanism that produces a finite verb in a low position in a non-V₂ clause. Moreover, under the articulated clause structure that comes with Aelbrecht's derivational timing analysis, there is a second derivational path to verb-stranding VP ellipsis that must be ruled out: namely, V moving to *v* and then to Voice, which is outside of the ellipsis site. These problems are obscured in Sailor's presentation, because he operates only with a tripartite C-T-V structure, abstracting away from *v* and Voice. Once the details of Aelbrecht's system are included, Sailor's solution is no longer complete.

In the next section we propose that both problems are solved by the understanding of head movement developed by H&G.

4 TWO TYPES OF HEAD MOVEMENT

The now-standard view of head movement as movement and adjunction (Baker 1988) is traditionally invoked as the mechanism behind both certain word order patterns (verb-initiality, verb second) and word formation patterns (e.g. affixation).

- (15) Syntactic head movement (where Y is the head of X's complement)

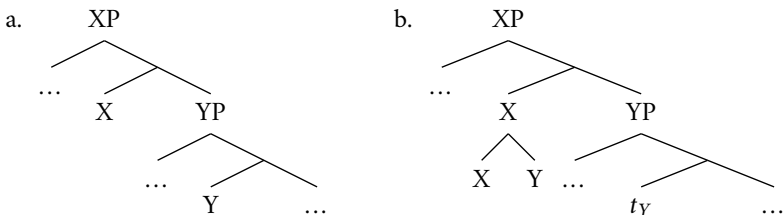

This formulation raises non-trivial theoretical problems that have been the focus of much attention in recent years.¹ One result of these discussions is a proliferation of accounts that attempt to reduce head movement to other mechanism(s) —

¹For thorough elaborations, see Matushansky 2006, Roberts 2010, Harizanov & Gribanova 2018.

e.g. remnant movement (Koopman & Szabolcsi 2000), PF movement (Chomsky 2001, Schoorlemmer & Temmerman 2012, Platzack 2013), re-projection (Georgi & Müller 2010), and others. H&G’s contention is that word formation and word order permutation phenomena are empirically distinct along several important dimensions, and that this difference indicates a need for two distinct and independently needed theoretical mechanisms: Internal Merge in the syntax, and a postsyntactic operation called *amalgamation*.

The main point is that certain properties associated with head movement cluster together in revealing ways, with only one cluster pointing to syntax-like behavior. This type of head movement can yield interpretive effects (indicating a syntactic movement, which feeds semantic interpretation); it has locality conditions akin to phrasal movement, violating the head movement constraint (Travis 1984); and it results in word order permutations, but not affixation or other morphological growth. The other cluster has properties which are not typical of syntax and therefore should be separated out: it never yields semantic effects, obeys the head movement constraint, and results in morphological growth (but not necessarily a higher point of pronunciation). This bifurcation, summarized in (16), has the beneficial result of resolving some of the theoretical issues usually associated with the traditional formulation in (15).

(16) Properties of syntactic head movement and postsyntactic amalgamation

	postsyntactic	syntactic
head-adjunction structures (\rightarrow words)	yes	no
driven by morphological properties of heads	yes	no
obeys the HMC	yes	no
potential for interpretive effects	no	yes

In H&G’s system, the syntactic type of head movement involves internal merge, either into the specifier (Matushansky 2006, Harizanov 2014) or as a form of re-projection (see Harizanov 2017 for details). Postsyntactic head movement consists of two operations, *Lowering* (Embick & Noyer 2001) and *Raising*, its opposite.

(17) Postsyntactic head *Lowering*:

$[_{XP} \dots X [_{YP} \dots Y [_{ZP} \dots]]] \rightarrow [_{XP} \dots [_{YP} \dots [_{Y} Y X] [_{ZP} \dots]]]$ (where Y and X are heads, X c-commands Y, and there is no head Z that c-commands Y and is c-commanded by X)

(18) Postsyntactic head *Raising*:

$[_{XP} \dots X [_{YP} \dots Y [_{ZP} \dots]]] \rightarrow [_{XP} \dots [_{X} Y X] [_{YP} \dots [_{ZP} \dots]]]$ (where Y and X are heads, X c-commands Y, and there is no head Z that c-commands Y and is c-commanded by X)

Lowering and *Raising* can apply independently or interact, depending on the specifications of particular heads in the clausal spine of a given language. Heads must be considered for amalgamation cyclically, bottom-up. Each head is associated

with a morphological feature $[M]$,² which may have either a positive or a negative (or no) specification. An $[M:+]$ feature results in *Raising* of a head; an $[M:-]$ specification results in *Lowering* of a head; and no specification will yield no application of either operation.

These syntactic and postsyntactic operations will of course interact; we consider this interaction in more detail when we examine how this proposal can be applied to Danish in the next section.

5 DANISH HEAD MOVEMENT AND ELLIPSIS, IN SYNTAX AND POSTSYNTAX

Adopting the H&G view of head movement, we argue, yields a natural explanation of finite tense inflection in non-V₂ clauses in Danish. This same explanation can be quite naturally leveraged to further explain the Danish-specific absence of verb-stranding VPE, while still providing independently motivated accounts of verb-stranding ellipsis in languages where it is attested.

In brief, adopting H&G's proposal allows us to model the morphological unification of Danish T and V in non-V₂ clauses by using the postsyntactic type of head movement — namely, *Lowering*. V₂ clauses will involve both the aforementioned postsyntactic amalgamation and syntactic movement of V directly to C. On this view, a main verb never survives VP ellipsis because:

- it is postsyntactically amalgamated to a position inside the ellipsis site (in ν), and
- the syntactic movement that could bring it outside the ellipsis ($\nu \rightarrow C$) is triggered after the ellipsis site is rendered inaccessible for syntactic processes.

5.1 POSTSYNTACTIC AMALGAMATION & ELLIPSIS IN DANISH EMBEDDED CLAUSES

In this section we consider first how this proposal will apply in embedded clauses, with and without ellipsis. There are two cases to be examined: in the presence of an auxiliary, that auxiliary will be inflected with T's features. In the absence of an auxiliary, the main verb is inflected. In both cases, the type of head movement involved patterns with H&G's postsyntactic amalgamation: it has no semantic effects, it obeys the HMC, and it results in growth of the morphological complex. Further, the inflected verb remains low relative to negation and adverbs despite bearing the exponent of T — a sign that postsyntactic *Lowering* is involved.³

²This is essentially a morphological selection feature; see Roberts 2010, Rizzi & Roberts 1989 for analogous ideas.

³We take this lower realization point to be ν , not V, for reasons having to do with the realization of the verb relative to indirect objects in double object constructions. None of our conclusions hinge on this particular view, however.

- (19) Postsyntactic (dashed) amalgamation in a Danish embedded clause, aux present

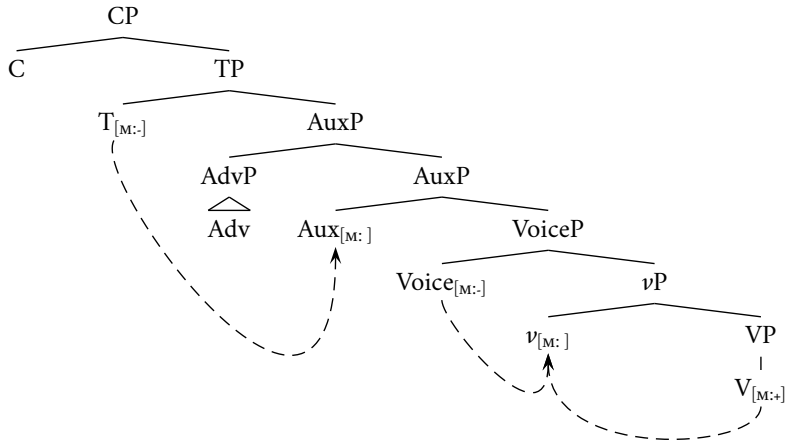

- (20) Postsyntactic (dashed) amalgamation in a Danish embedded clause, no aux present

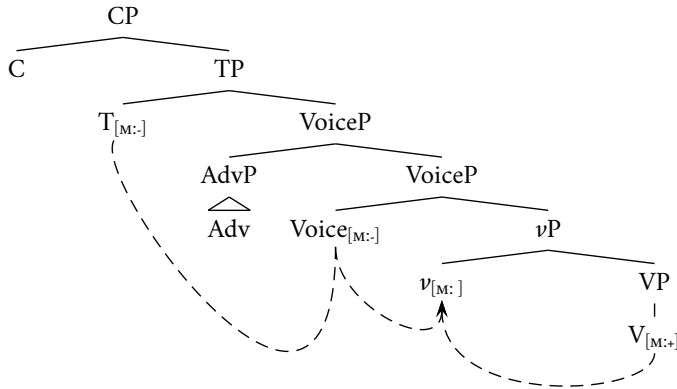

In (19) and (20), *Lowering* and *Raising* result from the featural specifications of each head ([M:·/·]). Each head in the syntactic structure is either *Lowered* or *Raised*, proceeding from bottom up. These being postsyntactic operations, once a head has amalgamated, it does not leave a trace or copy. The combination of these two assumptions results in the availability of configurations in which amalgamation of a head is not to the head of its complement, but the relation remains that of structural adjacency.⁴ In (20), going from bottom up, V has an [M:·+] feature and will therefore amalgamate into v. v's [M:] feature is not specified, so nothing hap-

⁴While the Embick & Noyer's (2001) definition of *Lowering* stipulates that a head *Lowers* to the head of its complement, this definition is too restrictive in the present theoretical context. Instead, the locality relation that needs to be established between the two heads participating in amalgamation is structural adjacency, as pointed out in (17) and (18). We take it that *Lowering* and *Raising* into structurally complex specifiers and adjuncts is prohibited by the island status of specifiers and adjuncts and refer the reader to n&g for further discussion of this point.

pens. The next head up, Voice, is specified to *Lower* and so amalgamates into ν . Once Voice has amalgamated, it exists only as part of the complex head that has resulted from amalgamation. This means that T, the next head going bottom-up, will lower directly into ν : the elimination of Voice from the postsyntactic clausal spine means that ν is the next head down in an immediate c-command relation with T.

With this much in place, we can return to ellipsis. The goal is to understand why the main verb never raises out of a VP ellipsis site in Danish. Given the structures above, the answer is now straightforward: in the presence of an auxiliary, the auxiliary will be merged outside the ellipsis site and stranded if ellipsis takes place; the main verb will be elided with the rest of ν P. Both instances of postsyntactic *Lowering* in (19) take place independently of the application of ellipsis.⁵

- (21) Postsyntactic amalgamation & ellipsis in a Danish embedded clause, aux present

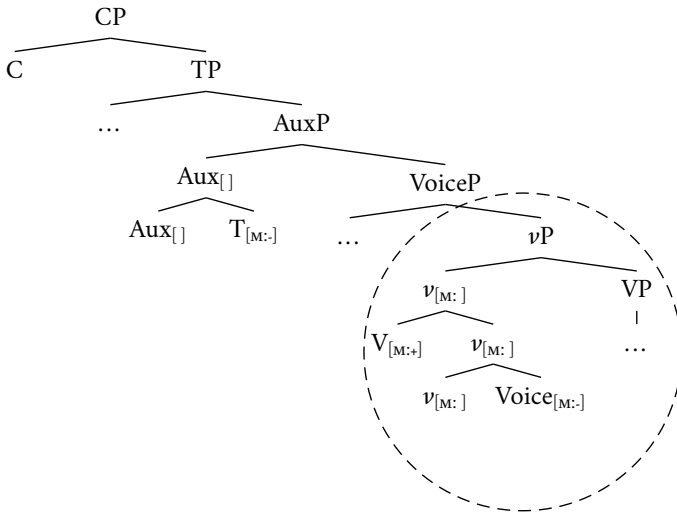

By contrast, when no auxiliary is present, everything amalgamates via *Lowering* and *Raising* to ν ; as a consequence, no verbal element will survive ν P ellipsis.

⁵Recall from (14) that Voice bears the *E*-feature in the syntax and will, as a result of an *AGREE* relation with the licensing head T, trigger ellipsis of its complement. The complement of Voice (ν P) is therefore marked for non-pronunciation long before the Voice head *Lowers* postsyntactically into the ellipsis site.

- (22) Postsyntactic amalgamation & ellipsis in a Danish embedded clause, no aux present

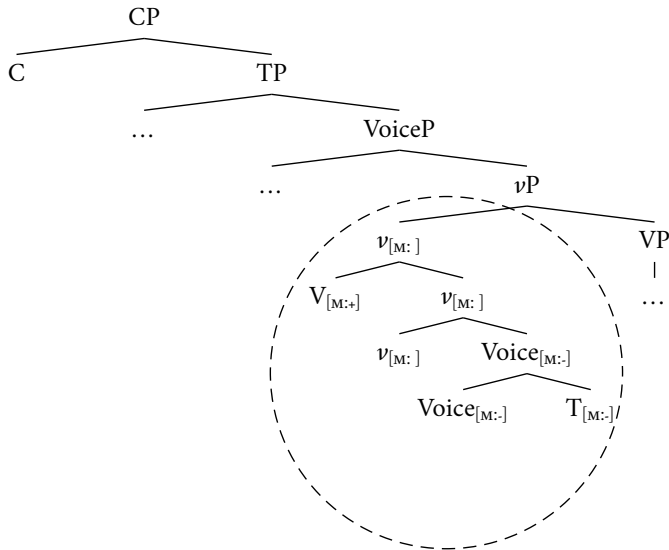

Taken at face value, the configuration above will yield an unattested result; namely, it will result in a stranded subject outside the ellipsis site (with T unpronounced).

- (23) *Jeg vasker bil, selv hvis Mona ikke ____.
I wash car even if Mona not ____.

There are two ways to explain what goes wrong in (22), thereby yielding the observation that (23) is ungrammatical. The first possibility is that, as in English, T has a requirement that its features be expounded. If T is stuck inside the ellipsis site, the conflict between the requirements of T and the requirements of ellipsis yields a crash at PF. The second possibility is that (22) fails for selectional reasons: the Voice head that bears the ϵ -feature may only be selected by an auxiliary, and not directly by T.⁶

5.2 POSTSYNTACTIC AMALGAMATION, SYNTACTIC HEAD MOVEMENT, & ELLIPSIS IN DANISH V2

Verb second clauses in Danish will involve both syntactic head movement to C and the amalgamation from the previous section. In H&G's approach, these interact in accordance with the Minimalist Y-model, wherein syntax feeds postsyntax. H&G's assumptions are that a) syntactic copies are instances of the same object in different loci;⁷ b) a change to the postsyntactic structure of one instance will

⁶For this explanation to hold, it is crucial that vP , not VoiceP, be the domain of ellipsis. Independent evidence in favor of this view comes from Merchant (2013).

⁷We represent distinct occurrences of a single syntactic object in the structure using multidominance. This is an expository choice, emphasizing the fact that we are dealing with a single syntactic object occupying distinct structural positions; other implementations are possible as well.

be reflected in all other instances of that object; and c) Chain Reduction marks some instance(s) for non-pronunciation. This set of assumptions will have the consequence that the pronounced instance will bear the reflexes of postsyntactic changes to any of the other instances. This will have the desired effect, namely the pronunciation of the entire verbal complex in the higher position (C) in verb second clauses. How does C know what to attract? An assumption we make, specific to Danish, is that the attracting feature on C will probe for a verbal element — an Aux or ν (a verbalizer). Locality conditions on probes and goals dictate that Aux will be attracted, if it is in the structure (see (24)). Otherwise, it will be ν , as in (25).

- (24) Postsyntactic amalgamation and syntactic head movement in a Danish V2 clause, aux present

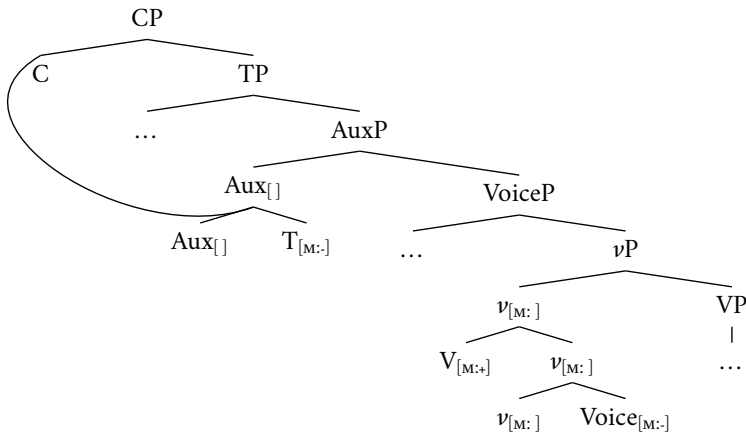

- (25) Postsyntactic amalgamation and syntactic head movement in a Danish V2 clause, no aux

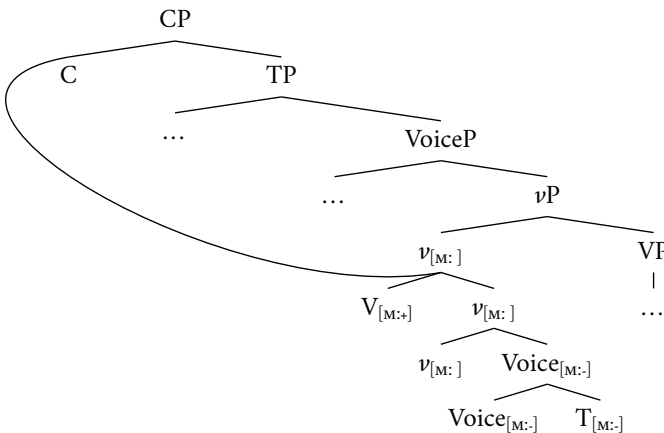

Now consider the interaction of verb movement and ellipsis in each of these structures. In (24) it is the auxiliary that is attracted to C and the main verb amal-

gamates in ν . Thus the auxiliary survives ellipsis of ν P, the main verb doesn't. What prevents main verb stranding if ellipsis applies in a structure with no auxiliary, as in (25)? Here, Sailor's original explanation can be put to use. In a bottom-up derivation, the derivation will introduce T, the ellipsis licensing head. At this stage, in accordance with Aelbrecht's system, everything inside the ellipsis site (ν P) will be rendered inaccessible. C will be introduced next into the derivation, and at this stage will not be able to attract the ν inside the ellipsis site. Syntactic movement of the main verb out of the ellipsis site is therefore blocked by the logic of the derivational timing involved in the triggering of ellipsis and the triggering of verb movement.

6 CONCLUSION

In this paper we have grappled with the question of how transparent ellipsis domains are for various kinds of movement, and in particular with understanding the lack of verb movement out of VP ellipsis in Danish. The absence of such movement, and thus of verb-stranding VP ellipsis in the language, is significant given two other observations. First, Danish VP ellipsis is transparent for A and A-bar movement, which indicates that there is regular syntactic structure in the ellipsis site, and thus a structural basis for verb movement — confirming some version of the TRANSPARENCY hypothesis with which this paper began its discussion. Second, since Jim McCloskey's seminal work on verb-stranding VP ellipsis in Irish, the construction has been widely documented in a range of typologically diverse languages. So the absence of verb movement out of VP ellipsis in Danish is a real puzzle for an otherwise very successful theory of ellipsis and its interaction with syntactic movement.

In a very important analytic move, Sailor (To appear) connects the lack of verb stranding VP ellipsis in Danish to the lack of movement of V to T independently of movement to C in the language. This is what sets Danish apart from Irish, Russian, Hebrew⁸ and other languages that do have verb-stranding VP ellipsis. The identity of the trigger for verb movement — C vs. T — matters if the ellipsis site is closed off for syntactic processes once the licensor of the ellipsis is Merged. This is exactly the analysis of ellipsis developed in Aelbrecht (2010), where she also identifies T as the licensor of VP ellipsis. Adopting Aelbrecht's theory of ellipsis, Sailor proposes that there is no verb movement out of VP ellipsis in Danish, because the trigger for this verb movement is C, which is Merged after T has rendered the ellipsis site inaccessible. This is an elegant and attractive solution to the puzzle. It is however, incomplete. One question left open by Sailor is what happens in embedded clauses where there is not movement to C, in particular what mechanism ensures tense inflection the verb in the absence of verb movement through T to C. The other question arises from a mismatch in the clause structures assumed by Sailor and Aelbrecht. Sailor operates with a

⁸However, see Landau 2017 for a critical reassessment of the claim that verb-stranding ellipsis is involved in the relevant Hebrew constructions.

simple V-T-C structure and thus the only movement that needs to be excluded to account for the lack of verb-stranding VP ellipsis is V moving to T or V moving to C. However, Aelbrecht's analysis of ellipsis requires a more articulated clausal spine containing V- ν -Voice-T-C, such that the host of [E] (Voice) can be separated from the licenser (T) so that elements inside the ellipsis site (ν P) can undergo movement to [Spec, Voice] (A-bar movement) or [Spec, T] (A-movement) before the ellipsis site is closed off.

The additional functional structure between V and T is relevant to Sailor's account because it raises the possibility of head movement between these various projections below T. If V could move to Voice via ν , that would be enough to get the main verb out of the ellipsis site and yield verb-standing VP ellipsis. Since this is movement below the ellipsis licenser T, the derivational timing pursued by Sailor account cannot be extended to rule out movement of V to Voice.

In this paper we have argued that these two gaps in Sailor's account are both addressed by the general theory of head movement developed by H&G and a straightforward extension of their analysis to accommodate the articulated clause structure required for Aelbrecht's analysis of VP ellipsis. On this view, there are two kinds of verb movement in Danish: postsyntactic amalgamation of T, Voice and V in ν which takes place in every clause, and syntactic head movement of ν to C which takes place only in V2 clauses. The complete explanation for the lack of verb-stranding VP ellipsis in Danish is thus two-fold: the verb cannot escape the ellipsis site by syntactic head movement because that movement is triggered after the ellipsis site is closed off by the Merger of T (Sailor To appear). Second, post-syntactic movement amalgamates T, Voice, ν , and V in ν , which is inside the ellipsis site.

Turning to languages that exhibit verb-stranding VP ellipsis, we observe that these are exactly the languages that H&G argue amalgamate high (above ν — i.e. *Raising* instead of *Lowering*), and thus the inflected verb survives ellipsis.

We'll end by returning to the full profile of which verbal elements can and must be stranded by Danish VP ellipsis. The profile is the same in main and embedded clauses and can be schematized as below:

- (26) Profile of Danish VPE (abstracted from (9)–(12))
- a. AUX _____
 - b. *gøre* _____
 - c. * MAIN V _____
 - d. * NO VERB _____

The focus of Sailor's paper is the contrast between (26a) and (26c) in main clauses. In this paper we have added to his analysis so that this contrast is accounted for in embedded clauses as well. Sailor notes the contrast between (26b) and (26d) in passing (Sailor To appear: 5) but does not attempt to account for it. With the explanation of Sailor's analysis provided here, we believe we are a step closer to being able to explain this contrast as well. While a full account must await another occasion, we'd like to make the following observations. Houser et al. (2011) argue

that *gøre* is an auxiliary, though it is limited in its distribution to environments where the verb phrase has a non-canonical realization (ellipsis, topicalization and pronominalization). This suggests that we should treat (26b) as a special case of (26a): *gøre* is an auxiliary that takes VoiceP as its complement. What makes *gøre* special is that it requires ellipsis. This, we propose, is because [E] is an inherent part of *gøre*'s featural specification. With regular auxiliaries ellipsis is optional: if [E] is present on Voice, vP is elided; if [E] is not present on Voice, there is no ellipsis. If *gøre* is present, so is [E], and VoiceP will be elided once T is Merged.

As for the ungrammaticality of (26d), we considered two possible explanations in connection with the derivation in (22). The first is that (26d) violates a hard requirement that T be exponed. This raises obvious questions of implementation and explanation: how would one implement such a requirement in a realizational theory of morphology and is it any more than a restatement of the observation? The second solution is that the structural configuration that would lead to (26d), namely the one in (22), never arises because T cannot combine with an [E]-laden Voice head. This is a very different type of account. It is not explanatory in any way, but it can be straightforwardly implemented within the assumptions of the rest of the analysis. Moreover, if such a selectional restriction is imposed, it would rule out verb-standing VP ellipsis (26c) without any appeal to derivational timing.

REFERENCES

- Aelbrecht, Lobke. 2010. *The syntactic licensing of ellipsis*. John Benjamins.
- Baker, Mark C. 1988. *Incorporation: A theory of grammatical function changing*. Chicago: University of Chicago Press.
- Chomsky, Noam. 2001. Derivation by phase. In Michael Kenstowicz (ed.), *Ken Hale: A life in language*, 1–52. Cambridge, MA: MIT Press.
- Culicover, Peter W. & Ray Jackendoff. 2005. *Simpler syntax*. Oxford: Oxford University Press.
- den Besten, Hans. 1983. On the interaction of root transformations and lexical deletive rules. In Werner Abraham (ed.), *On the formal syntax of the westgermania*, 47–131. Amsterdam: John Benjamins.
- Embick, David & Rolf Noyer. 2001. Movement operations after syntax. *Linguistic Inquiry* 32. 555–595.
- Georgi, Doreen & Gereon Müller. 2010. Noun-phrase structure by Re-Projection. *Syntax* 13(1). 1–36.
- Ginzburg, Jonathan & Ivan Sag. 2000. *Interrogative investigations*. Stanford, CA: CSLI Publications.
- Goldberg, Lotus. 2005a. On the verbal identity requirement in VP ellipsis. Presented at the *Identity in Ellipsis* workshop at UC Berkeley.
- Goldberg, Lotus. 2005b. *Verb-stranding vp ellipsis: A cross-linguistic study*. McGill University dissertation.

- Gribanova, Vera. 2013a. A new argument for verb-stranding verb phrase ellipsis. *Linguistic Inquiry* 44(1). 145–157.
- Gribanova, Vera. 2013b. Verb-stranding verb phrase ellipsis and the structure of the Russian verbal complex. *Natural Language and Linguistic Theory* 31(1). 91–136.
- Gribanova, Vera. 2017. Head movement, ellipsis, and identity. Stanford University.
- Gribanova, Vera. To appear. Head movement and ellipsis in the expression of Russian polarity focus. *Natural Language and Linguistic Theory*.
- Hardt, Daniel. 1993. *Verb phrase ellipsis: Form, meaning, and processing*: University of Pennsylvania, Philadelphia dissertation. Distributed as IRCS report 93-23.
- Harizanov, Boris. 2014. Clitic doubling at the syntax-morphophonology interface: A-movement and morphological merger in Bulgarian. *Natural Language and Linguistic Theory* 4(32). 1033–1088.
- Harizanov, Boris. 2017. On the nature of syntactic head movement. Colloquium, Department of Linguistics. McGill University, Montréal, Québec.
- Harizanov, Boris & Vera Gribanova. 2018. Whither head movement? Stanford University.
- Holmberg, Anders. 2001. The syntax of yes and no in Finnish. *Studia Linguistica* 55(2). 140–174.
- Houser, Michael, Line Mikkelsen & Maziar Toosarvandani. 2011. A defective auxiliary in Danish. *Journal of Germanic Linguistics* 23(3). 245–298.
- Koopman, Hilda & Anna Szabolcsi. 2000. *Verbal complexes*. Cambridge, MA: MIT Press.
- Landau, Idan. 2017. Missing objects in Hebrew: Argument ellipsis, not VP ellipsis.
- Lipták, Anikó. 2013. The syntax of emphatic positive polarity in Hungarian: evidence from ellipsis. *Lingua* 128. 72–92.
- Manetta, Emily. 2017. We say “how high?”: Adverbs, negation, and verb movement in a verb-final language. This volume.
- Manetta, Emily. To appear. Verb phrase ellipsis and complex predicates in Hindi-Urdu. *Natural Language and Linguistic Theory*.
- Matushansky, Ora. 2006. Head movement in linguistic theory. *Linguistic Inquiry* 37(1). 69–109.
- McCloskey, James. 1996. On the scope of verb raising in Irish. *Natural Language and Linguistic Theory* 14. 47–104.
- McCloskey, James. 2012. Polarity, ellipsis and the limits of identity in Irish. Workshop on Ellipsis, Nanzan University. <http://ohlone.ucsc.edu/~jim/PDF/nanzan-handout.pdf>.
- McCloskey, James. 2016. Ellipsis, polarity and the cartography of verb-initial orders in Irish. UC Santa Cruz.
- Merchant, Jason. 2001. *The syntax of silence: Sluicing, islands and the theory of ellipsis*. Oxford: Oxford University Press.
- Merchant, Jason. 2013. Voice and ellipsis. *Linguistic Inquiry* 44(1). 77–108.
- Merchant, Jason. 2017. Verb-stranding predicate ellipsis in Greek. This volume.
- Ngonyani, Deo. 1996. VP ellipsis in Ndendeule and Swahili applicatives. In Edward Garrett & Felicia Lee (eds.), *Syntax at Sunset, UCLA working papers in syn-*

- tax and semantics*, Number 1, 109–128. Department of Linguistics, UCLA.
- Platzack, Christer. 2013. Head movement as a phonological operation. In Lisa Lai-Shen Cheng & Norbert Corver (eds.), *Diagnosing syntax*, 21–43. Oxford: Oxford University Press.
- Rizzi, Luigi & Ian Roberts. 1989. Complex inversion in French. *Probus* 1(1). 1–30.
- Roberts, Ian. 2010. *Agreement and head movement: Clitics, incorporation, and defective goals*. Cambridge, MA: MIT Press.
- Ross, John Robert. 1969. GUESS WHO? In Robert Binnick, Alice Davidson, Georgia M. Green & Jerry L. Morgan (eds.), *Papers from the 5th regional meeting of the chicago linguistic society*, 252–286. Chicago, IL: Chicago Linguistic Society.
- Sailor, Craig. To appear. The typology of head movement and ellipsis: A reply to Lipták and Saab (2014). *Natural Language and Linguistic Theory*.
- Santos, Ana Lúcia. 2009. *Minimal answers. ellipsis, syntax and discourse in the acquisition of European Portuguese*. Amsterdam/Philadelphia: John Benjamins.
- Schoorlemmer, Erik & Tanja Temmerman. 2012. Head movement as a PF-phenomenon: evidence from identity under ellipsis. In Jaehoon Choi, E. Alan Hogue, Jeffrey Punske, Deniz Tat, Jessamyn Schertz & Alex Trueman (eds.), *Proceedings of the 29th West Coast Conference on Formal Linguistics*, 232–240. Somerville, MA: Cascadilla Press.
- Schuyler, Tamara. 2001. Wh-movement out of the site of VP ellipsis.
- Travis, Lisa. 1984. *Parameters and effects of word order variation*: MIT dissertation.
- Vikner, Sten. 1995. *Verb movement and expletive subjects in the Germanic languages*. Oxford: Oxford University Press.

A definiteness effect with THEME passives in West Flemish?^{*}

Liliane Haegeman
DiaLing Ghent University

1 VARIATION IN PASSIVISATION IN GERMANIC

1.1 OVERVIEW

It has been pointed out in the literature that the Germanic languages that have a double object pattern in ditransitives vary in their passivisation strategies. Table 1 provides a survey of some languages, discussed in Haddican and Holmberg (2014). English, for instance, productively deploys the passivisation of the GOAL (1a), while the THEME argument passivisation is more restricted (1b) (see Haddican and Holmberg 2012, 2014 for discussion).¹ On the other hand, in German the passivisation of the GOAL argument is not available (2a) and the THEME argument becomes the subject in a passive sentence (2b) argument (Alexiadou *et al* 2014:10).

Table 1: Germanic double object patterns and passivisation (Haddican and Holmberg 2014)

	English (1)	Danish	Swedish	Norwegian	German (2)	Dutch (3)
GOAL passive	√	√	√	√	*	* (%)
THEME passive	(√)	*	(√)	√	√	√

- (1) a. The girl was given the ball.
b. % The ball was given the girl. (Haddican and Holmberg 2012, 2014)

^{*}Jim McCloskey's work has been the inspiration for my own research: the combination of respect for the empirical data and analytical rigour is admirable and his work sets an example for the field. Moreover, Jim's sense of humour has to me consistently been a counterweight to what at times feels like overbearing seriousness in the field. This research is funded by FWO 3GoA4912 and by FWO project 2009-Odyseus-Haegeman-G091409. This paper was presented at the 2016 SDL 9 at the University of Geneva and at the 2017 LAGB meeting at the University of Kent. I thank the audiences for their comments. Special thanks to Lieven Danckaert, Marcel den Dikken, Line Mikkelsen, Terje Lohndal and Nomi Erteschik-Shir for very helpful comments on earlier versions of this work. Obviously, none of these can be held responsible for the way I have used these comments.

¹In English and in Swedish there is inter speaker variation, as documented in Haddican and Holmberg (2012, 2014). The standard view on Dutch is that the goal passive is unacceptable, hence *, but I will show presently that this does not represent all speakers, which the % sign is intended to show.

- (2) a. * Er wurde die Blumen geschenkt.
he.NOM was the flowers.ACC given
 ‘He was given the flowers.’
- b. Die Blumen wurden dem Mann geschenkt.
the flowers.NOM were the.DAT Mann given
 ‘The flowers were given to the man.’

The claim that, like German, Dutch only has the THEME passive and lacks a canonical GOAL passive is the core of Broekhuis and Cornips (2004, 2012), it is replicated in Broekhuis, Corver and Vos (2015), and is also adopted elsewhere in the generative literature (Alexiadou et al 2014:10).

- (3) a. * Hij werd het eten bezorgd (door mij).
he was the food delivered (by me)
 ‘He was delivered the food by me.’
- b. Het eten werd hem bezorgd (door mij).
the food was him delivered (by me)
 ‘The food was delivered to him by me.’

However, this claim is clearly a simplification and a subset of speakers of Dutch accept and produce GOAL passives (see Declercq 2016). Since the early 20th century, attestations of GOAL passive have been reported for Dutch (Wellander 1920, de Vooy 1949: 332-3, Van Haeringen 1956, 2006 :70, Kooiman 1963, Langendonck 1968, Den Besten 1981, Declercq 2016 on the recent literature). In the ANS, the comprehensive grammar of Dutch (Haeseryn et al 1997), as well as in the more formal literature (Broekhuis, Corver and Vos 2015), these data are often either ignored or set aside as performance errors. However, recent elicitation of Flemish and Dutch speakers reveals that throughout the Dutch speaking area, a subset of speakers accept GOAL passives. Google attestations of GOAL passives are also widely found (Haegeman 2016).

I will not address the status of standard Dutch here, but I concentrate on one of its dialects, West Flemish (WF), in which the passivisation strategy seems to be markedly different from that in standard Dutch. It is uncontroversial that that WF has GOAL passives (cf. section 1.2), and hence the question arises where while the passivization of the THEME argument at first sight leads to unacceptability, further scrutiny of the data reveals that the what might be interpreted as an ungrammatical pattern is in fact unacceptable because of information structural properties.

1.2 PASSIVIZATION IN WEST FLEMISH DISTRANSITIVES

WF undeniably has GOAL passives (Haegeman 1986a,b): (4) and (5) illustrate the pattern. In active (4a), the indirect object *Valère* is definite. In passive (4b), this nominal becomes the subject of the passive (see Haegeman 1896a,b, 2016 for arguments). The pattern is not idiosyncratic, as shown in Dhaenens (2014): a questionnaire distributed in 41 West Flemish locations showed a markedly higher accep-

tance rate for GOAL passives than the same questionnaire distributed in 50 East Flemish locations.

- (4) a. dan ze Valère die pillen vuorengeschreven een
that-PL they Valère those pills prescribed have
 ‘that they have prescribed Valère those pills’
- b. da Valère die pillen vuorengeschreven wierd / is
that Valère those pills prescribed ‘became’ / is
 ‘that Valère was prescribed those pills’

Observe that when the indirect object is an indefinite DP, as with the nominal *nen student* ‘a student’ in (5a), the GOAL passive remains available, but *der* insertion becomes obligatory (5b). The expletive varies in form depending on the preceding consonant and shows up as *der* or *ter* depending on the preceding consonant. I will refer to it as *der* insertion.

- (5) a. dan ze nen student die pillen vuorengeschreven een
that-PL they a student those pills prescribed have
 ‘that they prescribed a student those pills’
- b. dat *(ter) nen student die pillen vuorengeschreven wier
that there a student those pills prescribed was
 ‘that a student was prescribed those pills’

The insertion of expletive *der* is fully in line with the grammatical properties of WF: in this language, *der* insertion is systematically obligatory with WF indefinite subjects, as also shown in the active transitive expletive patterns in (6): regardless of the position of the indefinite subject *drie studenten* ‘three students’ to the right (6a) or to the left (6b) of the adjunct *gisteren* ‘yesterday’, *der* insertion is obligatory. The insertion of *der* is correlated directly with the indefiniteness of the subject; it does not arise with indefinite direct objects in active sentences as shown in (7):

- (6) a. dan *(der) gisteren drie studenten dienen boek gekocht een
*that-PL *(there) yesterday three students that book bought have*
- b. dan *(der) drie studenten gisteren dienen boek gekocht een
*that-PL *(there) three students yesterday that book bought have*
 ‘that three students bought that book yesterday’
- (7) dan *(der) de studenten gisteren drie boeken gekocht een
*that-PL *(there) the students yesterday three books bought have*
 ‘that the students bought three books yesterday’

Given that WF has a productive GOAL passive, the question arises how it fits into the typology schematized in table 1, i.e. is the THEME passive available in WF? At first sight, the judgments in (8) are puzzling. When the THEME is a definite DP,

THEME passivisation is judged to be highly degraded (8a,b)² and the alternative pattern with a GOAL PP (8c) is highly preferred. On the other hand, when the THEME is indefinite, passivisation is perfectly acceptable, as is the pattern with the PP GOAL (8d).

- (8) a. *?? dan die nieuwe pillen Valère voorgeschreven wieren
that-PL those new pills Valère prescribed were
- b. * dan Valère die nieuwe pillen voorgeschreven wieren
that-PL Valère those new pills prescribed were
- c. dan die nieuwe pillen an Valère voorgeschreven wieren
that-PL those new pills to Valère prescribed were
 ‘that those new pills were prescribed to Valère’
- d. dan der (an) Valère andere pillen voorgeschreven wieren
that-PL there (to) Valère other pills prescribed were
 ‘that other pills were prescribed to Valère’

This contrast is unexpected. One way of handling it might indeed be to conclude that WF in fact lacks a THEME passive and to analyze (8d) as some form of impersonal pseudo passive construction. In this paper, I argue against such a conclusion. I will show first that the indefinite THEME passive with the nominal GOAL in (8d) is a genuine passive, and I will then show that though the definite THEME passive in (8a) is indeed degraded, this is an epiphenomenon: a range of repair strategies can salvage the definite THEME passive. The data will reveal that the unacceptability of (8a) is in fact a function of information structural properties. Based on the discussion, I will thus conclude that WF has both a GOAL passive and a THEME passive, and thus patterns most closely with Norwegian in Haddican and Holmberg’s (2014) survey.

²Observe that in this respect, WF and standard Dutch are clearly different. In relation to the definite THEME passive, I provide just some citations from the literature. Ackema and Neeleman (2016:160, their (25)) illustrate the standard Dutch definite THEME passive in (1): in (1a) the THEME, *de boeken* ‘the books’, precedes the GOAL, *Jan*; in (1b) the THEME follows the GOAL. Observe that in both cases the finite passive auxiliary *werden* ‘became’ agrees with the plural THEME. As seen in (8), both orders are degraded in WF with the WF equivalent of (1b) being worse than the WF analogue of (1a).

- (1) a. Ik geloof dat de boeken Jan gegeven werden.
I believe that the books John given were
 ‘I believe that the books were given to John.’
- b. Ik geloof dat Jan de boeken gegeven werden.
I believe that John the books given were

Similarly, Broekhuis, Corver and Vos (2016: 1601) give (2) as grammatical in standard Dutch. Again the analogue of this example would be ungrammatical in WF because the definite subject must be adjacent to the finite verb in second position, thus neither the AGENT phrase nor the GOAL *Marie* can intervene.

- (2) Gisteren werden (door Jan) Marieio de boekensubject aangeboden.
yesterday were by Jan Marie the books prt.-offered.
 ‘Yesterday the books were offered to Marie (by Jan).’

The paper is organized as follows: Section 2 discusses the indefinite theme passive, section 3 shows that though at first sight the definite THEME passive is unavailable this conclusion is incorrect in view of a wider range of data in which such passives are fully productive. Section 4 explores the rescuing strategies for definite THEME passives and shows that the unacceptability of the definite THEME passive in (8a) is the outcome of the interplay of information structure and syntax. An additional illustration of the relevance for information structure for acceptability will be provided. Section 5 is a brief summary of the paper.

2 THE INDEFINITE THEME PASSIVE IN WEST FLEMISH

2.1 PASSIVE DIAGNOSTICS (BROEKHUIS AND CORNIPS 2012:1250 FF)

Broekhuis and Cornips (2013:1250 ff) offer a number of diagnostics for passivisation. These diagnostics identify the WF indefinite THEME passive as a regular passive.

2.1.1 THE AVAILABILITY OF THE AGENT

The AGENT can be explicit in the indefinite THEME passive, as illustrated in (9a) by the PP *van den specialist* ‘by the specialist’; as is the case in regular passives, an implied AGENT may control the interpretation of adjuncts, as shown in (9b), where *per ongeluk* ‘accidentally’ or *expres* ‘intentionally’ are AGENT-related.

- (9) a. dan der Valère andere pillen voorgescreven wieren
that-PL there Valère other pills prescribed were
van den specialist
 of the specialist
 ‘that other pills were prescribed to Valère by the specialist’
- b. dan der Valère per ongeluk / expres te vele pillen
that-PL there Valère by accident / intentionally too many pills
 voorgescreven wieren
 prescribed were
 ‘that Valère was prescribed too many pills by mistake/intentionally’

2.1.2 EVENTIVE PASSIVE

While in general, the preferred auxiliary for WF passives seems to be *zijn* ‘be’, the specialized passive auxiliary *worden* ‘become’ can also be used, as shown in (10), showing that the indefinite THEME passive is an eventive passive and hence that it cannot always be analyzed as some form of adjectival passive. Further evidence for the eventive interpretation of the passive comes from the fact that the indefinite THEME passive is compatible with temporal specifications (Broekhuis and Cornips 2012: 1252), as shown in (10).

- (10) dan der Valère almettekeer andere pillen voorengeschreven wieren
that-PL there Valère suddenly other pills prescribed were
 ‘that all of a sudden Valère was prescribed other pills’

2.1.3 SUBJECT PROPERTIES OF THE INDEFINITE THEME

In the indefinite THEME passive, the THEME nominal acquires the properties of the subject. (i) It agrees with the finite verb and with the complementizer: in (11a), the THEME *en andere flasse* is singular, in (11b) the THEME *andere pillen* ‘other pills’ is plural, triggering the appropriate agreement.

- (11) a. dat-SG ter Valère en Marie en andere flasse voorgeschreven wier
that there Valère and Marie another bottle prescribed was
 ‘that Valère and Marie were prescribed another bottle’
 b. dan-PL der Valère andere pillen voorgeschreven wieren
that there Valère other pills prescribed were
 ‘that Valère was prescribed other pills’

Because the THEME subject is indefinite, insertion of expletive (*der*) in the subject position is obligatory. This is a property that characterises all indefinite subjects in WF, as already discussed in relation to (6). As shown in (12), the absence of *der* leads to ungrammaticality:

- (12) a. * dat-PL Valère en Marie een andere flasse voorgeschreven wier
that Valère and Marie another bottle prescribed was
 b. * dan-PL Valère andere pillen voorgeschreven wieren
that Valère other pills prescribed were

In the passive examples, the indefinite THEME remains in a low position: it follows the GOAL argument and it precedes the lexical verb. While more research is needed, I tentatively assume that the indefinite THEME remains in a VP-internal position. Evidence for this hypothesis is the fact that in a configuration of Verb Projection raising the indefinite THEME remains within the ‘raised’ VP. As shown in (13) the GOAL may remain within the VP (13a) or it may be outside it (13b).

- (13) kweten niet waarom dan-der
I know not why that-PL there
 a. zoun moeten [Valère andere pillen voorengeschreven worden].
should must Valère other pills prescribed be
 b. Valère zoun moeten [andere pillen voorengeschreven worden].
Valère should must other pills prescribed be
 ‘I don’t know why Valère should be prescribed other pills’

A full analysis of the indefinite THEME passive is not the goal of this paper. I provisionally assume the partial representation in (14). I follow Haddican and Holmberg (2012) and assume that in THEME passives, the GOAL merges as the specifier

of ApplP and receives case from the head Lk. Expletive *der* merges as SpecvP, it agrees with VP internal THEME, and it moves to specTP. See also Deal (2009). Crucial is that the case of the GOAL is unaffected by passivisation; it may remain VP internally (14a) or it may undergo Object Shift (14b). Observe also that the GOAL must be taken not to block agreement between T/*der* and the vP-internal THEME.

- (14) a. [TP *der* T [VP ~~*der*~~ v . . . [LkP [AppIP GOAL [VP THEME V]]]]]
 b. [TP *der* T GOAL [VP ~~*der*~~ v . . . [LkP [AppIP ~~GOAL~~ [VP THEME V]]]]]

3 THE DEFINITE THEME PASSIVE IN WEST FLEMISH

As already discussed, while the WF THEME passive is productive, the judgements for (15) and (16) might lead one to the conclusion that the definite THEME passive is not available in WF. In (15) the THEME *die pillen* ‘those pills’ is plural, in (16) the THEME *die andere flasse* ‘that other bottle’ is singular. In the a-examples, the THEME precedes the GOAL, the examples are degraded. The degradation is worse, though, with the reversal of the order, i.e. when the definite THEME is separated from the complementizer by the GOAL. As shown by the c-examples, the alternative pattern in which, like in the a-examples, the THEME is adjacent to the complementizer and in which the GOAL is expressed by a PP headed by the preposition *an* (‘to’) are fully acceptable.

- (15) a. *??dan die pillen Valère vuorengeschreven wieren
that-PL those pills Valère prescribed were
 b. * dan Valère die pillen vuorengeschreven wieren
that-PL Valère those pills prescribed were
 c. dan die pillen an Valère vuorengeschreven wieren
that-PL those pills to Valère prescribed were
 that those pills were prescribed to Valère’
- (16) a. *?? dat die andere flasse Valère en Marie vuorengeschreven wier
that-SG that other bottle Valère and Marie prescribed was
 b. * dat Valère en Marie die andere flasse vuorengeschreven wier
that-SG Valère and Marie that other bottle prescribed was
 c. dat die andere flasse an Valère en Marie vuorengeschreven wier
that-SG that other bottle to Valère and Marie prescribed was
 ‘that that other bottle was prescribed to Valère and Marie’

One may try to account for the unacceptability of the definite THEME passive by, for instance, appealing crucially to the role of *der* as a mediator in T-agreement and in the satisfaction of the EPP on T. As a specific implementation, one might, for instance follow Mikkelsen (2002) and propose that the THEME is case-marked by the passive participle and is hence inactive. The expletive *der* satisfies the EPP

on T. Because of the definiteness effect associated with *der* insertion, with a definite THEME there would be no way of satisfying the EPP on T. However, taking into account a wider range of data will reveal that in fact, WF definite THEME passives are not always unacceptable. Thus, while the patterns in (15a) and (16a) remain unacceptable, it will turn out that they are not to be used in support of a claim that WF lacks a definite THEME passive. On the other hand, to the best of my knowledge, the (b)-variants of (15) and (16) are solidly ungrammatical in all contexts and, this is in line with the grammar of WF in that there is a strict adjacency requirement on the definite subject in relation to the complementizer or the finite verb in C.

3.1 MIDDLEFIELD INSERTION STRATEGIES

While (15a) and (16a) are felt to be unacceptable by informants, it turns out that this is a relative judgement. Indeed, the examples can be ‘salvaged’ by adding ‘weight’. Typically, for instance, inserting middle field material rescues the definite THEME passive: the additional material can come in different forms and be associated with different functions, some of which are illustrated in (17): in (17a-c), a temporal (17a), aspectual (17a,17b) or modal (17c) adjunct is added ³, in (17d) an AGENT phrase is inserted, in (17e) a subject-related floating quantifier is added, in (17f) the pattern is salvaged by the presence of a polarity marker and in (17g), the presence of the discourse particle *toch* ‘nevertheless’ rescues the pattern.⁴

- (17) a. dan die posten Karen gisteren / twee keers beloofd zyn
that-PL those jobs Karen yesterday / two times promised was
 ‘that Karen was promised those jobs yesterday/twice’
- b. dan die posten Karen al beloofd woare
that-PL those jobs Karen already promised were
 ‘that Karen has already been promised those jobs’
- c. dan die posten Karen verzekerst/alleszins beloofd woaren
that-PL those jobs Karen probably/definitely promised were
 ‘that Karen was probably/definitely promised those jobs’
- d. dan die pillen Karen van den dokter voorgeschreven wieren
that those pills Karen of the doctor prescribed were
 ‘that Karen was prescribed those pills by the doctor’

³The category/length of the adjunct does not seem to matter, the adjunct can be an adverb (*verzekerst* ‘probably’, *al* ‘already’), a nominal *verleden joare* (‘last year’), a PP (*in Leuven* ‘in Louvain’).

⁴The degradation of the definite theme passive and the repair strategies which consist of supplying adjuncts are reminiscent of the observations on English passives in Grimshaw and Vikner (1993). These authors show that English passives of monotransitives sometimes necessitate what seems to be an obligatory adjunct, a phenomenon which I return to briefly in sections 4.3.1 and 4.4.2, and which they account for in terms of Event structure. I will not pursue their account here because, as shown in Section 4.4.1, the effect discussed for WF also arises with a subset of active sentences, for which Grimshaw and Vikner’s (1993) account would not be relevant. In addition, with respect to the passive patterns discussed here, the specific restrictions on the type of adverbial adjuncts noted in Grimshaw and Vikner (1993) for English do not obtain in WF: to the best of my knowledge, any middle field constituent can salvage the offending definite THEME passive.

- e. dan die posten Karen alle twee beloofd zyn
that-PL those jobs Karen both promised are
 ‘that Karen was promised both those jobs’
- f. dan die pillen Karen niet/wel vuorengeschreven wieren
that those pills Karen not/wel prescribed were
 ‘that Karen was not/indeed prescribed those pills’
- g. dan die pillen Karen toch vuorengeschreven wieren
that-PL those pills Karen PART prescribed were
 ‘that Karen was nevertheless prescribed those pills’

These rescuing strategies do not salvage (15b) or (16b) in which the definite THEME in the passivized pattern is separated from the complementizer by the GOAL. This is shown in (17') below: these minimally differ from the corresponding examples in (17) by the position of the additional material. I return to this contrast in section 3.2.

- (17') a. * dan Karen die posten gisteren / twee keers beloofd zyn
that-PL Karen those jobs yesterday / two times promised was
- b. * dan Karen die posten al beloofd woaren
that-PL Karen those jobs already promised were
- c. * dan Karen die posten verzekerst/alleszins beloofd woaren
that-PL Karen those jobs probably/definitely promised were
- d. * dan Karen die pillen van den dokter voorgeschreven wieren
that Karen those pills of the doctor prescribed were
- e. * dan Karen die posten alle twee beloofd zyn
that-PL Karen those jobs both promised are
- f. * dan Karen die pillen niet/wel vuorengeschreven wieren
that Karen those pills not/wel prescribed were
- g. * dan Karen die pillen toch vuorengeschreven wieren
that-PL Karen those pills PART prescribed were

3.2 PASSIVE PROPERTIES OF DEFINITE THEME PASSIVES

Based on the diagnostics in Broekhuis and Cornips (2012:1250), the non-primed examples of definite THEME passives in (17) are to be taken as regular passives. In particular, (17d) shows that an AGENT phrase is available, (17d,f,g) show that the specialized passive auxiliary *worden* ‘become’ can be used. As would be expected under a passivisation analysis, the definite THEME also acquires subject properties. I go over these briefly here.

Like other definite subjects, the THEME in definite THEME passives must be adjacent to the complementizer in embedded clauses (18a) and to the finite verb in root clauses with subject inversion (18b). This adjacency condition also captures the severe ungrammaticality of the reordering of GOAL and THEME in (8c),

(15b), (16b) and the primed examples in (17). Like the subject nominal, the definite THEME argument is adjacent to the complementizer: in (18a) the intervention of the adverbial *verzekest* ('probably') renders the example ungrammatical. Like the subject nominal, the definite THEME argument agrees with finite verb and with the complementizer: this is illustrated for the plural nominal *die pillen* 'those pills' in (18b) and for the plural nominal *die posten* ('those jobs) in (18a) and (18c). When pronominal, the definite THEME is realised as a nominative pronoun, and like other nominative DPs, it (marginally⁵) allows for pronoun doubling (18d). When relativized, the definite THEME is associated with relative *die* and the pattern gives rise to *dat/die* alternations (18e,f) (cf. Haegeman 1984). I take these data to be sufficient to conclude that the indefinite THEME in the non-primed examples in (17) is indeed the subject of the passive verb, and hence that contrary to first impressions, in addition to the GOAL passive, documented in (4) and (5), WF also has a THEME passive.

- (18) a. dan (*verzekest) die posten Karen doarom beloofd wieren
*that-PL (*probably) those jobs Karen for that reason promised were*
- b. Wieren (*doarom) die pillen Karen niet voorengeschreven?
*were (*for that reason) those pills Karen not prescribed*
 'Is that why Karen was not prescribed those pills?'
- c. dan/*dat die posten Karen doarom beloofd wieren/*wier
that-PL/that-SG those jobs Karen for that reason promised were/was
 'that that is the reason why Karen was promised those jobs'
- d. dan ze (?zunder) Karen doarom voorengeschreven wieren
that-PL they (they) Valère for that reason prescribed were
 'that she was promised them for that reason'
- e. die pillen dien Karen vroeger voorengeschreven wieren
those pills die-PL Karen before prescribed were
 'those pills that used to be prescribed to Karen'
- f. die pillen dan-k peinzen dien Karen vroeger voorengeschreven wieren
those pills that-1SG-I think die-PL Karen before prescribed were
 'those pills that I think used to be prescribed to Karen'

3.3 ADJUNCTS AND DEFINITE THEME PASSIVES

As shown in (17), adding weight to an 'unadorned' definite THEME passive such as (15a) or (16a) by adding some middle field material salvages the definite THEME passive. However, the position of the middle field material is not free. In particular, comparing (17) and (19) reveals that the definite THEME passive can only be salvaged when the rescuing material is inserted to the right of the GOAL-DP. In terms of standard assumptions about Germanic syntax, this can be interpreted to mean that the definite THEME passive requires object shift (OS) of the GOAL-DP across the 'rescuing' middle field constituent, whether this be an adjunct, a

⁵In general, pronoun doubling is less favoured, though not completely *, with non-human subjects, which is why *zunder* is less favoured.

by phrase, a floating quantifier or some discourse particle. (19) shows that the non-primed licit patterns in (17) systematically become ungrammatical when the GOAL *Karen* fails to undergo OS:

- (19) a. * dan die posten gisteren/twee keers Karen beloofd zyn
 that-PL those jobs yesterday/two times Karen promised zyn
- b. * dan die posten al Karen beloofd woaren
 that-PL those jobs already Karen promised were
- c. * dan die posten verzekerst/alleszins Karen beloofd woaren
 that-PL those jobs probably/definitely Karen promised were
- d. * dan die pillen van den dokter Karen voorgeschreven zyn
 that-PL those pills of the doctor Karen prescribed are
- e. * dan die posten alle twee Karen beloofd zyn
 that-PL those jobs both Karen promised are
- f. * dan die pillen niet/wel Karen vuorengeschreven wieren
 that-PL those pills not/wel Karen prescribed were
- g. * dan die pillen toch Karen vuorengeschreven wieren
 that-PL those pills PART Karen prescribed were

Given that the definite THEME DP is adjacent to the complementizer or to the inverted finite verb and that it has subject properties, I conclude that it has moved to the canonical subject position. Apparently, such THEME movement is only possible provided the GOAL DP undergoes OS, or, using Broekhuis's (2009) terminology, THEME movement to the subject position has a "push up" effect.⁶ There is no push up effect when a definite THEME becomes the subject of a ditransitive passive in which the GOAL is realized as a PP: as shown by the examples in (20), a PP GOAL argument may follow all middle field material:

- (20) a. dan die posten gisteren/al an Karen beloofd zyn
 that-PL those jobs yesterday/already to Karen promised zyn
 'that those jobs were promised to Karen yesterday/already'
- b. dan die pillen van den dokter an Karen voorgeschreven zyn
 that-PL those pills of the doctor to Karen prescribed are
 'that those pills were prescribed to Karen by the doctor'

3.4 MIDDLEFIELD ADJUNCTS AND PUSH UP

The push up effect observed with respect to word order patterns in the definite THEME passive reflects a general condition governing the movement of the di-

⁶In the indefinite THEME passive, the indefinite THEME itself does not move, so there is no push up effect: the GOAL argument *Karen* may follow the adjunct or it may precede it. Recall also that the adjunct itself is not obligatory.

- (i) dan der (verleden joare) Karen (verleden joare) twee posten beloofd wieren
 that-PL there (last year) Karen (last year) two jobs promised were

rect object in WF (and Dutch) ditransitives. As I have demonstrated at length in my earlier work on order preservation (Haegeman 1993a,b,c, 1994), leftward movement of a direct object is only possible provided the indirect object undergoes OS. The pattern is discussed, among others, in den Dikken (1995: 207-208) Anagnostopoulou 2003: 215-20, Fox and Pesetsky 2005, Broekhuis 2009 etc. For instance, Broekhuis (2009: 243) states that ‘OS is blocked when it has to cross the main verb or some co-argument, the moved object forces movement of these elements as well’. I first briefly sum up the relevant WF data.

In ditransitive sentences with a middle field adjunct and without movement of the direct object, the indirect object may follow or precede the middle field adjunct: in (21a) the adjunct *verzekerst* ‘probably’ precedes both indirect object and direct object, in (21b) the indirect object has undergone OS and precedes the adjunct, in (21c) both indirect object and direct object have undergone OS and precede the adjunct:

- (21) a. dat Valère verzekerst zen broers dienen boek angeroaden eet
that Valère probably his brothers that book recommended has
 b. dat Valère zen broers verzekerst dienen boek angeroaden eet
that Valère his brothers probably that book recommended has
 c. dat Valère zen broers dienen boek verzekerst angeroaden eet
that Valère his brothers that book probably recommended has
 ‘that Valère has probably recommended this book to his brothers’

When the direct object is relativized, OS of the indirect object is obligatory: (22a), in which the indirect object DP *zen broers* ‘his brothers’ follows the adjunct *verzekerst* ‘probably’ is ungrammatical: in the licit (22b), the indirect object precedes the adjunct. The push up effect is only observed with DP indirect objects. When the indirect object is realised as PP, it is immune to the push up effect. In (22c), relativization of the direct object is compatible with the indirect object PP remaining to the right of the adverbial adjunct *verzekerst* ‘probably’.

- (22) a. * dienen boek da Valère verzekerst zen broers angeroaden eet
that book that Valère probably his brothers recommended has
 b. dienen boek da Valère zen broers verzekerst angeroaden eet
that book that Valère his brothers probably recommended has
 ‘that book that Valère probably recommended to his brothers’
 c. dienen boek da Valère verzekerst an zen broers angeroaden eet
that book that Valère probably to his brothers recommended has
 ‘the book that Valère probably recommended to his brothers’

The push up effect is also observed with clitic objects such as *t* (‘it’) or *ze* (‘her’, ‘them’) (Haegeman 1993a,b,c). In (23a) the object clitic *het* (‘it’) precedes the indirect object *Marie*. OS of the indirect object is crucial here: in (23b), the clitic precedes an indirect object which has not undergone OS and the result is ungrammatical. (23d) shows that the PP indirect object is not subject to the push up effect.

- (23) a. dat Valère verzekerst Marie dat geld beloofd heeft
that Valère probably Marie that money promised has
 ‘that Valère probably promised the money to Mary’
- b. dat Valère het Marie waarschijnlijk beloofd heeft
that Valère it Marie probably promised has
 ‘that Valère probably promised it to Mary’
- c. * dat Valère het waarschijnlijk Marie beloofd heeft
that Valère it probably Marie promised has
- d. dat Valère het verzekerst an Marie beloofd heeft
that Valère it probably to Marie promised has
 ‘that Valère probably promised it to Marie’

The push up effect also regulates the distribution of indirect and direct objects in verb projection raising patterns, the indirect object and the direct object may remain with the ‘raised’ VP, as shown in (24a). However, when the object is moved, by relativization (24b) or because it is a weak pronoun (24e), the indirect object must also be extracted, failure to do so leads to severe ungrammaticality (24c,f). As before, PP indirect objects are not sensitive to the constraint (24d,g).

- (24) a. da Valère zou willen [Marie dienen tekst tuogen]
that Valère would want Marie that text show
 ‘that Valère would want to show Marie the text’
- b. dienen tekst da Valère Marie zou willen [tuogen]
that text that Valère Marie would want show
- c. * dienen tekst da Valère zou willen [Marie tuogen]
that tekst that Valère would want Marie show
- d. dienen tekst da Valère zou willen [an Marie tuogen]
that tekst that Valère would want to Marie show
 ‘that text that Valère would want to show to Marie’
- e. da Valère t Marie zou willen [tuogen]
that Valère it Marie would want show
 ‘that Valère would want to show it to Marie’
- f. * da Valère t zou willen [Marie tuogen]
that Valère it would want Marie show
- g. da Valère t zou willen [an Marie tuogen]
that Valère it would want to Marie show
 ‘that Valère would want to show it to Marie’

Returning to the definite THEME passive the addition of middle field material salvages what otherwise would be unacceptable patterns. The obligatory OS of the GOAL argument is not specific to the definite THEME passive and follows from whatever accounts for the push up effect observed in other contexts.

3.5 ADDITIONAL RESCUING STRATEGIES

While adding weight via the insertion of middle field material is one productive strategy for rescuing the ‘unadorned’ indefinite THEME passive, other strategies are available which, at least at first sight, do not affect the middle field. I discuss two of these here, both of which consist in adding focused material.

3.5.1 ADDING AN EXTRAPOSED CONSTITUENT

(25) shows that while the unadorned definite THEME passive is ungrammatical (25a), the pattern can be salvaged by the addition of sentence-final post-verbal material: in (25b) a PP of purpose is added, in (25c) there is an additional temporal clause, in (25d) the AGENT is post-verbal. Observe that the sentence final constituents in (25b,c,d) are not destressed; indeed, introducing a prosodic break after the finite verb and destressing the post-verbal constituents leads to ungrammaticality, as shown (25e-g):

- (25) a. *?? dan die pillen Karen voorgeschreven zyn
that-PL those pills Karen prescribed are
- b. dan die pillen Karen voorgeschreven zyn voor euren sciaticiek
that-PL those pills Karen prescribed are for her sciatica
‘that Karen was prescribed these pills for her sciatica problem’
- c. dan die pillen Karen voorgeschreven zijn oa ze nog ziek was.
that-PL those pills Karen prescribed are when she still ill was
‘that Karen was prescribed these pills when she was ill’
- d. dan die pillen Karen voorgeschreven zyn van den dokter
that-PL those pills Karen prescribed are of the doctor
‘that Karen was prescribed these pills by the doctor’
- e. *?? dan die pillen Karen voorgeschreven zyn, voor euren sciaticiek.
that-PL those pills Karen prescribed are for her sciatica
- f. *?? dan die pillen Karen voorgeschreven zijn, oa ze nog ziek was.
that-PL those pills Karen prescribed are when she still ill was
- g. *?? dan die pillen Karen voorgeschreven zyn, van den dokter
that-PL those pills Karen prescribed are of the doctor

The sentence-final additions in (25a-d) are not presupposed, but like extraposed constituents they constitute part of the focus (new information) (Broekhuis *et al* 2016:1549). Indeed, as shown in the next section, the addition of focused material also salvages the ‘unadorned’ definite THEME passive.

3.5.2 FOCUSING STRATEGIES

Though speakers judged unadorned definite THEME passives unacceptable, they sometimes pointed out that the sentences improved markedly with the addition of focal stress. For instance, in relation to (26a) below, one informant assigned the example ‘?’ with the following comment:

moet je beetje voor werken: er moet iemand anders zijn waarvan iemand denkt/beweert dat hem/haar die slaapmiddelen waren voorgeschreven.

Tr: 'you must do some work here: there must be someone else about whom it is thought that those sleeping pills had been ascribed to that person.'

Clearly then, this informant adds contrastive stress to *Ciro* in order to salvage the unadorned definite THEME passive. (26b) is also much improved: in this example, the GOAL is a negative quantifier *niemand*, which also receives focal stress.

- (26) a. ?K peinzigten dan die pillen CIRO voorgeschreven wieren.
I thought that-PL those pills CIRO prescribed were
 'I thought that CIRO had been prescribed those pills.'
- b. ?K peinzigten dan die pillen NIEMAND voorgeschreven wieren.
I thought that- PLthose pills no one prescribed were
 'I thought that no one was prescribed those pills.'⁷

Similarly, stressing the lexical verb itself may increase acceptability: in (27) stressing the particle *of* 'off' creates an effect of contrastive or corrective focus on the verb: (27) is understood to introduce a contrast with other events in which a course was recommended or alternatively it corrects a previous proposition according to which a course was recommended:

- (27) dat dienen cursus al de studenten OF geroaden wier
that that course all the students 'dis recommended' was
 'that all students were advised against this course'

So, in addition to the strategy of adding weight to an unadorned definite THEME passive by inserting middle field material, the other strategy for rescuing such patterns is the addition of new information focus or contrastive or corrective focus. The focused constituent may be in the middle field (i.e. a negative GOAL argument, or stress on the verb) or it may be an extraposed constituent. At first

⁷The GOAL passive would be acceptable for (19). For (19a) the GOAL passive requires the reordering of GOAL and THEME (1); for (19b) with the indefinite subject *niemand* both orders in (2) are acceptable. *Der* insertion is obligatory (cf. section 1.2 for discussion).

- (1) a. *K peinzigten da die pillen CIRO voorgeschreven wier.
I thought that-SG those pills CIRO prescribed was
- b. K peinzigten da CIRO die pillen voorgeschreven wier.
I thought that-SG CIRO those pills prescribed was
 'I thought that CIRO had been prescribed those pills.'
- (2) a. K peinzigten dat ter die pillen niemand voorgeschreven wier.
I thought that-SG there those pills no one prescribed was
- b. K peinzigten dat ter niemand die pillen voorgeschreven wier.
I thought that-SG there no one those pills prescribed was
 'I thought that no one was prescribed these pills.'

sight, a purely syntactic account that brings together these strategies is not obviously available. In the next section I will propose that in fact the data suggest that what excludes the unadorned definite THEME passive is a deficit in terms of information structure: the unadorned definite THEME passive is informationally incomplete in the sense of Erteschik-Shir (2007:187-9).

4 THE INTERPLAY OF SYNTAX AND INFORMATION STRUCTURE: A SKETCH

Recall the core contrasts in WF: while an indefinite THEME passive is productive (28a), an unadorned definite THEME passive is felt to be highly degraded and requires the addition of some ‘weight’ in the form, for instance, of a middle field adjunct (28b). A definite THEME passive in which the GOAL argument is expressed as a PP is acceptable without requiring any additional material (28c).

- (28) a. dan der Valère andere pillen vuorengeschreven wieren
 that-PL there Valère other pills prescribed were
- b. dan die pillen Valere *??(vroeger) vuorengeschreven wieren
 that-PL those pills Valere (before) prescribed were
- c. dan die pillen an Valère voorgescreven wieren
 that-PL those pills to Valère prescribed were

These data raise the following, related, questions:

- (i) Why does definite THEME passive (28b) contrast with the fully natural ‘plain’ indefinite THEME passive (28a)?
- (ii) Why is the ‘plain’ unadorned definite THEME passive (28b) felt to be degraded?
- (iii) What is the precise role of the ‘salvaging’ strategies, i.e. inserting middle field material (such as an adverbial adjunct, an AGENT by phrase, a floating quantifier, a polarity marker, a discourse particle), inserting extraposed material, or adding stress on the GOAL argument or on the lexical V. Is any one property shared by all of these?

In what follows I will show that the patterns in (28) follow from the interaction of information structure with specific syntactic properties of WF, in particular with the push up effect triggered by movement of the definite THEME argument to subject position.

4.1 INGREDIENT 1: PUSH UP

As I have discussed at length in previous work (Haegeman 1993a,b,c, 1994) WF ditransitive sentences display a rigid ordering restriction in the middle field, and in particular

- (i) the definite subject cannot be separated from the complementizer or from the finite verb in C;
- (ii) the indirect object always precedes the direct object.

When the direct object moves across the indirect object, for instance in the case of relativization (22) or when it is a clitic, as shown in (23), repeated here in (29a,b), this ‘pushes’ up the indirect object, which has to undergo OS (Broekhuis 2009). (29d-e) schematically represents the effect of Push up on clitic movement: basically, the data amount to saying that the direct object can only reorder with the indirect object provided the latter undergoes OS. The pattern as such is of importance and had led to wide ranging discussions in the literature (cf. den Dikken 1995: 207-208, Anagnostopoulou 2003: 215-20, Fox and Pesetsky 2005, Broekhuis 2009 and many others). I will not attempt here to provide an account for the push up effect and refer to the literature cited, but I will focus on its interaction with and relevance for passivisation in WF.

- (29) a. dat Valère het Marie waarschijnlijk beloofd heeft
that Valère it Marie probably promised has
 ‘that Valère probably has promised it to Marie’
- b. * dat Valère het waarschijnlijk Marie beloofd heeft
that Valère it probably Marie promised has
- c. dat DOCL IO adjunct IO-DO Vlex aux
- d. * dat DOCL adjunct IO DO Vlex aux

In the definite THEME passives, the THEME moves to the canonical subject position. By assumption, this is to satisfy the EPP on T. The movement of the object entails that the GOAL-DP has to undergo OS (hence it appears to the left of the middle field adjunct/particle).⁸

4.2 INGREDIENT 2: THE INTERPRETATION OF OS

In WF neutral transitive sentences, the VP internal direct object constitutes the new information focus. OS affects constituents that are ‘given’ or ‘presupposed’ and which evacuate the VP focus domain. For instance, Holmberg 1999: 23 writes: ‘[OS] arguments moved out of the VP are interpreted as presupposed’ (Holmberg 1999:23). The relevant shifted DP is destressed (cf. ‘Destress Given’, Féry and Samek-Lodovici 2006, Kratzer and Selkirk 2007: 97). When an argument DP undergoes OS, it becomes disqualified as a focus. Let us look at the effect of OS on the interpretation of passive configurations in WF.

⁸A negative IO/GOAL may follow a middlefield adjunct (i). (i) is not to be construed as evidence against the ‘push up’ effect (Broekhuis 2009): in (i) the negative IO/GOAL enters into a concord relation with a negative adverb to its right, suggesting that it has vacated the vP internal position and undergone NEG-movement to a middlefield position (Haegeman 1995, Haegeman & Zanuttini 1993):

- (i) dat diene cursus NIEMAND niet (meer) aangeroaden is
that that course no one no (more) recommended is

4.3 THEME PASSIVISATION IN WEST FLEMISH

4.3.1 THEME PASSIVES OF DITRANSITIVES

My starting point in this paper was the observed degradation in acceptability of the unadorned definite THEME passive in WF ditransitive sentences. (30a) has the schematized representation in (30b). Because the theme argument *die pillen* ‘those pills’ moves to the canonical subject position, the goal argument *Valère* must also evacuate the VP.

- (30) a. *?? dan die pillen Valère vuorengeschreven wieren
that those pills Valère prescribed were
b. *?? dan die pillen Valère [_{VP} ~~Valère die pillen~~ vuorengeschreven] wieren

The net outcome of the derivation is thus that with respect to ditransitive patterns, the ‘unadorned’ definite THEME passive lacks a VP-internal constituent which can carry the focus. Lacking focus, the ‘unadorned’ definite DO/THEME passive is ‘informationally incomplete’ (in the sense of Erteschik-Shir 2007:187-9). Salvaging the pattern is achieved by supplying a constituent that can constitute a focus, be this in a middle field position or in an extraposed position.

The degradation of the unadorned definite THEME passive in WF (30a) is like that of the English passive in (31a), which was originally discussed by Grimshaw and Vikner (1993) in terms of a deficiency in Event Structure and was subsequently reanalyzed in terms of an information structural deficiency by Erteschik-Shir (2007: 189, her (87a)):

- (31) a. * The book was written. (2007:189: (87a))

Erteschik-Shir attributes the ungrammaticality of this example to a deficiency of information structure, which can be remedied by adding material which will supply a focus:

What is “wrong” with [31a] must . . . be that it is incomplete in that it lacks a focus. Once an element is added to supply such a focus, the sentence becomes good [31b]. The verbs in [31c] and [31d] do not need additional elements in order to be complete. They provide a focus in and of themselves.

- (31) b. The book was written last year/in 2005/by Chomsky. (2007:189, (88))
c. The book was revised. (2007:189: (87b))
d. The book was destroyed. (2007:189: (87c))

The acceptability of WF (28c), repeated as (32a), in which a GOAL indirect object is realized as a PP is expected: the push up effect in the Dutch middle field is restricted to DP arguments, PP arguments, including GOAL indirect objects are immune to this effect, as shown in (22c), (23d) and (24d,g) (Haegeman 1993a,b,c, 1994). Thus in (32a) the indirect object PP may remain VP internally (32b) and, crucially, may be associated with focus:

- (32) a. dan die pillen an Valère voorgeschreven wieren
that-PL those pills to Valère prescribed were
 ‘that those pills were prescribed to Valère’
- b. dan die pillen [_{VP} an Valère ~~die pillen~~ vuorengeschreven] wieren

The degradation observed for the unadorned definite THEME passive does not arise with an unadorned indefinite THEME passive. Because the indefinite THEME remains VP internally (13), the VP contains material eligible for carrying focus. As a result, the need to supply an alternative focus does not arise.

- (33) a. dan der Valere andere pillen vuorengeschreven wieren
that-PL there Valere other pills prescribed were
- b. dan der verleden joare Valere andere pillen vuorengeschreven wieren
that-PL there last year Valere other pills prescribed were

On the basis of the passivisation data discussed in this paper, I hope to have shown that WF does have both a productive GOAL passive and a productive THEME passive. Restrictions such as that revealed by the judgements produced on the definite THEME passive in section 1.2 do not challenge this conclusion.

4.3.2 THEME PASSIVES OF MONOTRANSITIVES

I add for completeness’ sake that, as was the case for the English data in (31) above which were first discussed in Grimshaw and Vikner (1993) and reanalyzed by Erteschik-Shir (2007), passivisation of a (mono)transitive with a definite THEME is also unnatural in WF. Again, adding some additional material such as an adjunct or an extraposed constituent would render such examples fully natural.

- (34) dan die andere medicamenten *??(nie meer) gemaakt worden
that-PL those other medications (no more) made are
 ‘that those other pills are (no longer) prescribed’

4.4 ANOTHER CASE OF INFORMATION INCOMPLETENESS: OBJECT PRO- NOUNS

The role played by information structure in determining acceptability is clear in the case of the definite THEME passive. There are other environments where the same interplay of information structure and syntax can be observed. I illustrate one such case here.

In WF (35a) the direct object is a definite nominal *dat werk* ‘that job’. It has to follow the indirect object *Marie*; the alternative order (35b) is ungrammatical. (35c), in which the object is a pronominal element *t* ‘it’ which follows the indirect object is degraded: the pronoun has to precede the indirect object (35d). This might be interpreted to mean that the pronominal object is a syntactic clitic which targets a specialized position higher than that of the indirect object.

- (35) a. da Valère Marie dat werk beloofd eet
that Valère Marie that job promised has
 ‘that Valère has promised Marie that job’
- b. * da Valère dat werk Marie beloofd eet
that Valère that job Marie promised has
- c. ?? da Valère Marie t beloofd eet
that Valère Marie it promised has
- d. da Valère t Marie beloofd eet
that Valère it Marie promised has
 ‘that Valère has promised it to Marie’

However, to my ear, the degradation in (35c) is not as sharp as that in (35b), which violates order preservation. Indeed, the order in (35c), where the object pronoun follows the indirect object DP, actually becomes acceptable provided the pronoun is followed by middle field constituents such as adverbial, polar particle, discourse particle (36a) or floating quantifier (36b).

- (36) a. da Valère Marie t verleden weke/wel/toch beloofd eet
that Valère Marie it last week/indeed/PART promised has
 ‘that Valère promised it to Marie last week/indeed/nevertheless’
- b. da Valère Marie ze alletwee beloofd eet
that Valère Marie them both promised has
 ‘that Valère promised them both to Marie’

Haegeman (1993a,b,c, 1994) develops a (complex) syntactic analysis according to which the pronoun is as a syntactic clitic and in which supplying the additional middle field constituent somehow contributes to creating or licensing the functional projection whose head can host the clitic. But the analysis does not obviously capture the fact that extraposed constituents or stressing the lexical verb also rescues the pattern, as illustrated in (37).

- (37) a. da Valère Marie t beloofd eet voor t noste weke
that Valère Marie it promised has for the next week
 ‘that Valère promised it to Marie for next week’
- b. ? da Valère Marie t BELOOFD eet
that Valère Marie it promised has
 ‘that Valère has PROMISED it to Marie’

It is not clear, though, that such a fully syntactic analysis is required to account for the degradation of (35c). Again, along the lines developed in section 3, it would appear that these data follow from the interaction between information structure and object shift.

It is uncontroversial that the pronominal object *t* (‘it’) encodes presupposed/given information and exits the VP by OS. As discussed, object movement entails that the indirect object, here *Marie*, is pushed up and must also undergo OS (cf. (23)

and (24g)). This is schematized in (38). Because both the object pronominal and the indirect object evacuate the VP, the resulting sentence becomes informationally “incomplete” (in the sense of Erteschik-Shir 2007) and supplying alternative focus will salvage the sentence.

- (38) * dat DO_{PRONOUN} adjunct [IO ØØ] Vlex aux
 dat DO_{PRONOUN} IO adjunct [IØ ØØ] Vlex aux

The data in (37) reveal that the pronominal object *t* (‘it’) can occupy more than one position in the clause. Whether the position which the pronoun occupies in (37), in which it follows the OS indirect object, is a syntactic clitic position or corresponds to the OS position that would host a direct object DP needs to be examined further (see Haegeman 1993a,b,c, 1994).⁹

5 SUMMARY OF THE PAPER

This paper examines the acceptability patterns in WF passivisation, with the main focus on THEME passivisation. Whereas in standard Dutch, GOAL passives are reported to be restricted to ‘non-canonical passives’ (Broekhuis & Cornips 2012), WF GOAL passives are fully productive, with both indefinite and definite GOALS. On the other hand, while standard Dutch THEME passives are reported to be fully productive, at first sight judgements for WF THEME passives reveal what looks like a definiteness asymmetry: with an indefinite THEME, passivisation is fully productive, but passivisation of a definite THEME is judged unacceptable, and speakers have recourse to the alternative THEME passivisation strategy with a PP GOAL.

Closer scrutiny reveals, however, that an offending THEME passives can be salvaged by the insertion of ‘middle field’ material, such as, e.g., adverbial adjuncts, which has to be inserted to the right of the GOAL, or by adding an extra-posed constituent. Stress on the indirect object or on the lexical verb also leads to considerable improvement.

⁹Broekhuis, Corver and Vos (2016: 1664) discuss the distribution of object pronominals as follows: while direct objects normally follow nominal indirect objects under a neutral intonation pattern [1a], weak pronominal direct objects normally precede indirect objects. Example [1b] shows that this holds regardless of whether the indirect object is non-pronominal or pronominal. It should further be noted that it also holds if the two object pronouns have the same form: the first object pronoun in *dat Peter ‘m ‘m aanbood* ‘that Peter offered it to him’ is construed as the direct object.

- (1) a. dat Peter <*de auto> Marie <de auto> aanbood.
 that Peter the car Marie the car prt.-offered
 ‘that Peter offered Marie the car’
 b. dat Peter <‘m> Marie/’r <?? ‘m> aanbood.
 that Peter him Marie/her him prt.-offered
 ‘that Peter offered it to Marie/her’

We may speculate that the degradation in the position of the weak pronoun <‘m> to the right of the indirect object *Marie* in (1b) may well be of the same nature as that discussed for WF in the present paper and thus may be due to the interaction between syntax and information structure.

In the paper, the definiteness effect in *THEME* passives, which is initially suggested by the contrast in judgements between the ‘unadorned’ definite *THEME* passive and its indefinite counterpart, is reinterpreted in terms of information structure. Definite *THEME* passivisation ‘pushes up’ the *GOAL* argument, a pattern well known from the literature (cf. Haegeman 1993a,b,c,1994, Broekhuis 2009). Arguments which are extracted out of VP by OS are interpreted as given or presupposed. This entails that in the case of definite *THEME* passivisation, the shifted *GOAL*, which due to push up must undergo OS, must be presupposed. This leads to an imbalance in information structure: by movement of both the *THEME* and the *GOAL*, the resulting VP lacks the new information focus which is by default associated with a VP internal constituent and the resulting utterance is ‘informationally incomplete’ (Erteschik-Shir 2007:187-9). The ‘definiteness effect’ detected in the initial acceptability judgements is thus reanalyzed as a by-product of the push up effect on object movement. The diverse repair strategies are unified in that they all supply a focus. Indefinite *THEME* passives are fully acceptable because the indefinite *THEME* remains VP-internally, hence there is no push up effect and the *THEME* itself can constitute a VP-internal focus.

The paper shows that the distribution of WF object pronouns too can be partly interpreted in terms of the interaction between syntax and information structure and thus does not necessitate the highly complex syntactic analysis outlined in Haegeman (1993a,b,c, 1994).

A question for future work is how best to capture the role of information structure in determining acceptability and to which degree these effects are themselves inscribed into the syntax.

REFERENCES

- Ackema, Peter and Ad Neeleman (2016). *Features of Person*. Ms. University of Edinburgh /UCL.
- Afarli, Tor. 1992. *The syntax of Norwegian passive constructions*. Amsterdam: Benjamins.
- Alexiadou, Artemis, Elena Anagnostopoulou and Christina Sevdali. 2014. Opaque and transparent datives, and how they behave in passives. *The Journal of Comparative Germanic Linguistics* 17:1-34.
- Anagnostopoulou, Elena. 2003. *The Syntax of Ditransitives*. Berlin: Mouton de Gruyter.
- ANSBesten, Hans. den. 1981. A case filter for passives. In Adriana Belletti, Lucia Brandi and Luigi Rizzi (eds), *Theory of Markedness in Generative Grammar. Proceedings of the 1979 GLOW Conference*. Pisa Scuola Normale di Pisa. 65-122.
- Broekhuis, Hans. 2009. Holmberg’s Generalization. Blocking and push up. In Artemis Alexiadou, et al., *Advances in Comparative Germanic Syntax*. Amsterdam/Philadelphia: John Benjamins Publishing Company, 219-245.
- Broekhuis, Hans and Leonie Cornips. 2004. Undative constructions. *Linguistics* 32: 173-189.

- Broekhuis, Hans and Leonie Cornips. 2012. The verb krijgen 'to get' as an undative verb. *Linguistics* 50: 1205-1249.
- Broekhuis, Hans, Norbert Corver and Riet Vos. 2015. *Verbs and verb phrases*. Vol I. *The syntax of Dutch*. Amsterdam University Press.
- De Vooyo, Cornelis Gerrit Nicolaas 1949/1960. *Nederlandse Spraakkunst*. Groningen.
- Deal, Amy Rose. 2009. The origin and content of expletives. *Syntax* 12: 285-323.
- Declercq, Kato. 2016. *Naar een verbeterde beschrijving van het persoonlijk passief in de Algemene Nederlandse Spraakkunst. Een studie van de recente taalkundige literatuur*. Master paper. Dutch Linguistics. Ghent University.
- Dikken, Marcel den. 1995. On the syntax of verb-particle, triadic, and causative Constructions. Oxford: Oxford University Press.
- Dhaenens, Gilles. 2014. *Perspectivische variatie van de actieve dubbelobject-constructie: passieve en receptieve varianten*. Bachelor paper, Ghent University.
- Erteschik-Shir, Nomi. 2007. *Information structure: the syntax-discourse interface*. OUP.
- Féry, Caroline and Vieri Samek-Lodovici. 2006. Focus projection and prosodic prominence in nested foci. *Language* 82: 131-150.
- Fox, Dany and Pesetsky, David. 2005. Cyclic Linearization of Syntactic Structure. *Theoretical Linguistics* 31: 1-45.
- Grimshaw, Jane and Sten Vikner. 1993. Obligatory adjuncts and the structure of events. *Knowledge and language concepts*. Dordrecht: Kluwer, 143-55.
- Haddican, William and Anders Holmberg. 2010. Theme-goal ditransitives and theme passivisation in British English dialects. *Lingua* 120: 2424-2443.
- Haddican, William and Anders Holmberg. 2012. Object movement symmetries in British English dialects: experimental evidence for a mixed case/locality approach. *Journal of Comparative Germanic Linguistics* 15: 189-212.
- Haddican, William and Anders Holmberg. 2014. Kinds of Object Symmetry. In L. Veselovská and M. Janebová (eds), *Complex visibles out there: Proceedings of Olinco 2014*, Palacký University, Olomouc: 145-162.
- Haegeman, L. 1984. *Die* and *dat* in West Flemish relative clauses. In: Hans Ben- nis and W. Van Lessen Kloeke (eds.). *Linguistics in the Netherlands*. Dordrecht. Foris. 83-91.
- Haegeman, L. 1986a. Passivisation in Flemish dialects. In Frits Beukema and Aafke Hulk (eds), *Linguistics in the Netherlands*. Dordrecht: Foris. 71-78.
- Haegeman, L. 1986b. The double object construction in West Flemish. *The Linguistic Review* 5: 281-300.
- Haegeman, L. 2016. The canonical goal passive in Dutch and its dialects. Lingbuzz: lingbuzz/003105
- Haegeman, Liliane 1993c. The distribution of object pronouns in West Flemish. In: Lars Hellan and Luigi Rizzi (eds.). *Eurotyp working papers. Programme in language typology*. European Science Foundation.
- Haegeman, Liliane. 1993a. Some speculations on argument shift, clitics and crossing in West Flemish. In: Werner Abraham and Josef Bayer (eds.). *Linguistische*

- Berichte*, Special issue *Dialektsyntax*: 131-16
- Haegeman, Liliane. 1993b. The morphology and distribution of object clitics in West Flemish. *Studia Linguistica* 47: 57-94.
- Haegeman, Liliane. 1994. The typology of syntactic positions: L-relatedness and the A/A' distinction. In Werner Abraham en Jan-Wouter Zwart (eds.). *GAGL*, 37, Special issue: *The minimalist programme*: 115-157.
- Haeringen, Coenraad Bernardus van 1956. *Nederlands tussen Duits en Engels*. Den Haag: Servire. DBNL 2006.
- Haeseryn, Walter, Kirsten Romijn, Guido Geerts, Jaap de Rooij and Maarten C. van den Toorn. 1997. *Algemene Nederlandse Spraakkunst (ANS)*. Groningen: Martinus Nijhoff/ Deurne: Plantyn.
- Holmberg, A. 1999. Remarks on Holmberg's generalisation. *Studia Linguistica*: 1-39.
- Kooiman, Klaas. 1963. Als in het Engels, maar niet uit het Engels. *De Nieuwe Taalgids* 26: 33-40.
- Kratzer, Angelika and Lisa Selkirk. 2007. Phase theory and prosodic spell out. *The Linguistic Review* 24: 93-135.
- Langendonck, Willy. van. 1968. Het meewerkend voorwerp van de actieve zin als onderwerp van de passieve zin. *Leuvense Bijdragen. Tijdschrift voor Germaanse Filologie*. 57: 101-118.
- Mikkelsen, Line. Reanalyzing the definiteness effect: evidence from Danish. *Working Papers in Scandinavian Syntax* 69: 1-75.
- Neeleman, Ad, Elena Titov, Hans van de Koot and Reiko Vermeulen. 2009. A syntactic typology of topic, focus and contrast. Alternatives to cartography. *Studies in Generative Linguistics*. 100, 15-51
- Van den Toorn, Maarten C. 1971. Enkele opmerkingen over het indirect object. *Levende Talen* 274: 32-41.
- Wellander, Erik. 1920. Over den datief als subject van een passieve constructie. *De Nieuwe Taalgids* 14: 291-299.

Ellipsis as a Test for Constituency

Jorge Hankamer
University of California, Santa Cruz

In textbooks, and in beginning syntax classes, ellipsis is cited as a diagnostic for constituency. For example:

"One type of constituency test involves what is conventionally called ELLIPSIS, often called DELETION, which is the omission of part of a sentence under circumstances where its meaning can be determined from context or from the structure of the sentence. The standard hypothesis is that only a constituent can be omitted and not an arbitrary substring." (Culicover 2009, p.80.)

Ellipsis could, of course, be a reliable diagnostic for constituency if the "standard hypothesis" is true and only constituents can be elided. I will argue that there are (at least) two types of ellipsis, one of which can provide a reliable test for constituency (since it reliably elides a constituent) and one which cannot. This second kind either does not elide a constituent or must be analyzed in such a way as to make it useless as a test for constituency.

Section 1 presents some essential background perhaps unnecessary for most readers of this volume, such as what counts as ellipsis as opposed to mere optionality; but since there has been some confusion in the literature, and since the issue is when exactly we can count on ellipsis as a test for constituency, it is probably best to be explicit.

Section 2 outlines a typology of ellipsis processes, distinguishing (at least) two types, for now called types A and B. Type B ellipses do not transparently elide constituents. Section 3 briefly discusses attempts to analyze type B ellipses as constituent ellipsis, and Section 4 is a conclusion, in which it is argued that ellipsis can be used as a test for constituency, but in different ways for each type of ellipsis: type A ellipses do (most of the time) elide constituents; in type B ellipsis, the remnants after ellipsis are always constituents.

1 WHAT IS ELLIPSIS?

Some textbooks include "omission" as a constituency test, citing the optionality of certain modifiers as indicators of constituency:

- (1) a. They filled the order (on Thursday).

- b. The trolls were hiding (under a bridge).
- c. The (very large) dog (that I bought) eats too much.

Such examples, however, do not involve ellipsis but merely reflect the fact that modifiers are optional. Similarly, the fact that some verbs (such as 'eat') can be either transitive or intransitive has nothing to do with ellipsis, but reflects either optionality of the complement or a choice between different lexical items.¹

Ellipsis, as the word is commonly used in linguistics, is a subtype of anaphora:² a systematic relation wherein one linguistic element (the anaphor) depends for its interpretation on some other element (the antecedent).

Further, the term "ellipsis" will not be used for A-bar phenomena such as the gaps (primary or parasitic) in such constructions as relative clauses and comparative clauses. To be sure, the generally held assumption is that these gaps result from A-bar movement, but I have seen "Comparative Deletion" mentioned among putative "ellipsis" phenomena ([en.wikipedia.org/wiki/Ellipsis_\(linguistics\)](http://en.wikipedia.org/wiki/Ellipsis_(linguistics))). I will discuss a genuine ellipsis phenomenon occurring in comparative clauses (Comparative Ellipsis) in section 2.5.

Other phenomena involving silence that I do not count as ellipsis are those involving (according to most current analyses) silent pro-forms of various kinds: big PRO and little pro, for example. Whatever analysis is assumed for those things, their properties are too dissimilar from the ones dealt with in this paper for it to make sense to call them by the same name. For similar reasons, "argument ellipsis" (see, for example, Cheng 2013) is not ellipsis either.³

2 A TYPOLOGY OF ELLIPSIS

The purpose of this section is to develop a typology of ellipsis processes which will be useful in subsequent discussion of the suitability of ellipsis as a test for constituency.

We will start with an inventory of the (more or less) well-studied ellipsis pro-

¹Omission is not a very good constituency test, either:

- (i) The (big red barn) door fell on me.
- (ii) We (might have) hurt the puppy.
- (iii) (We believed until yesterday that) the disease was incurable.

The fact that the sequence of words "big red barn" can be grammatically omitted from (i) does not mean that it is a constituent in that sentence. Similar observations can be made for (ii) and (iii).

²I use the term "anaphor" in its more general sense, and not to denote that subset of anaphoric expressions that are subject to Condition A of the Binding Theory. Thus, to count as ellipsis, an "omission" must be recoverable from (linguistic) context. I will henceforth follow Hankamer and Sag 1976 in assuming that ellipsis is equivalent to "surface anaphora" and that the relevant context is inevitably linguistic context (and not, for example, some aspect of the situational context not expressed in linguistic form). I also assume, since no credible evidence contradicts it, that ellipsis is always optional.

³Unfortunately, some people (e.g. Aoun and Benmamoun 1999, Depiante 2000, Culicover and Jackendoff 2005) use the term "bare argument ellipsis" to mean Stripping. That, of course, is ellipsis.

cesses:⁴ VP Ellipsis, NP Ellipsis, Sluicing, Stripping, and Gapping. I will argue that there are (at least) two kinds of ellipsis processes, with very different properties. We will then discuss several less well-studied ellipsis phenomena in the light of the resulting typology, with an eye toward developing a fairly complete picture of the known landscape of ellipsis.

2.1 VPE, NPE AND SLUICING

Verb Phrase Ellipsis (VPE) usually involves elision of a VP:

- (2) While I have never ridden a camel, Ivan has [ridden a camel].
- (3) While I have never ridden a camel, I would like to [ride a camel].
- (4) While I have ridden a camel, Ivan has not [ridden a camel].
- (5) While I won't ride camels, Ivan will [ride camels].
- (6) I didn't ride the camel. Ivan did [ride the camel].

The name is not entirely apt, however, because complements of the copula, which can be DP, AP, or PP, can also be elided, and there is no reason to believe that this is a different process:

- (7) The children weren't ready to go home, but the parents were [ready to go home].
- (8) If your GPS tells you you are in Nebraska, you probably are [in Nebraska].
- (9) Harvey thinks he's not a loser, but he is [a loser].

Adopting an insight of Zagona (1982) and Lobeck (1995), we will characterize "Verb Phrase Ellipsis" as the elision of the complement of a T, Neg, or Aux (where, of course, the copula is an Aux).⁵ Thus VPE is not characterized as ellipsis of a VP, but as the ellipsis of the complement of one of the set of licensing heads T (including present and past, Modals, and infinitival 'to'), Neg, and Auxes.⁶

Support for this characterization comes not only from the ellipsis of non-VP complements of the copula, but from several constructions in which a VP is not the complement of one of the licensing heads, and such VPs cannot be

⁴I use the term "ellipsis process" to denote the grammatical representation of any of several distinct phenomena involving the interpretation of a stretch of silence by direct reference to a linguistic antecedent. My use of this term should not be taken as a commitment to any set of assumptions about the exact mechanism by which this relation is established.

⁵It won't do to think that Auxes appear to license VPE simply because they have raised to T, because even an Aux which cannot have raised to T can license VPE:

- (i) Harvey is upset, and we don't want him to be.
- (ii) We hope Harvey didn't steal the car, but he might have.
- (iii) We think Harvey stole the car, but he might not have.

This is on the standard assumption that only one Aux raises to T.

⁶It is a mystery what unites this class of licensors. Mostly they are heads that select VP complements, but the inclusion of copula be spoils that.

elided. First consider VPs modified by VP-initial adverbs like 'never' and 'seldom' (chosen because they apparently cannot re-adjoin to the right, escaping the VP):

- (10) Sue has never seen a camel.
- (11) * Sue has seen a camel never.
- (12) * Sue has never seen a camel, and I have never [seen a camel] either.
- (13) * Sue has seldom complained about money, and her mother has also seldom [complained about money].

In these cases the inner VP is not the complement of a licensing head, and cannot be elided (for example, in (13) the complement of *have* is the VP *also seldom complained about money*; the inner VP *complained about money* is not the complement of a licensing head).

Another case where a VP can occur without a licensing head is in Small Clause constructions, and here too VPE is impossible:

- (14) * I saw a man beating a donkey, but I didn't see a woman [beating a donkey].
- (15) * I saw a man beating a donkey, and I saw a woman [beating a donkey] too.
- (16) * I wanted my eggs seasoned with paprika, and Harvey wanted his rice [seasoned with paprika].

(Examples (14)-(16) are of course grammatical where what I saw or didn't see was a woman, and what Harvey wanted was his rice.)

Noun Phrase Ellipsis (NPE), first identified by Jackendoff (1971), appears to elide an NP:

- (17) Sue's snide remark about the Dean was not as clever as Harvey's [snide remark about the Dean].
- (18) You scratch my back and I'll scratch yours [back].⁷

Not just any NP can be elided, however, because unless the NP is the complement of a Possessive D (or a demonstrative D, or whatever D hosts demonstratives in its specifier, and similarly for quantifiers), the ellipsis is not licensed:

- (19) *Ivan was riding a big ugly camel, and I rode a little pretty [camel].⁸

⁷It's amusing that pronominal possessors in English have a special form that they must appear in when adjacent to an NPE ellipsis site.

⁸There is, of course, a distinct anaphoric process that can apply in examples like (i), called one(s) anaphora:

- (i) Ivan was riding the big ugly camel, and I rode the little pretty one.

One(s) anaphora, while providing an excellent constituency test, is not ellipsis according to the standard I have adopted (it's a kind of Deep Anaphora), so I will not discuss it further in this article. Note, though, that there are languages in which the one-anaphor is silent:

- (ii) Juan montaba el camello grande, y yo montaba el chico. [Spanish]
Juan rode the camel big and I rode the small

I will assume that NPE, like VPE, is licensed by certain heads, and consists in the elision of the complement to that head (under suitable conditions of recoverability, which are not the focus of this paper, though I will continue to assume that recoverability requires reference to a linguistic antecedent).

An interesting subcase of NPE, investigated thoroughly in LaCara (2010), involves ellipsis of the VP complement of the possessive D in constructions like (20-21):

- (20) I could stand the cat's wailing all night, but I couldn't stand the baby's [wailing all night].
- (21) The cat's wailing all night was easier to stand than the baby's [wailing all night].

Here the elided material is a VP, but the licensing head is clearly the possessive D, so I will assume, along with LaCara, that what is involved here is not VPE, but NPE. Whatever it is, note that here as in the VPE cases discussed above, if the VP is separated from the licensing head by an adverb, the ellipsis becomes impossible:

- (22) * I was used to Marie's quietly complaining about the food, but I was surprised at Harvey's loudly [complaining about the food].

Of course, if the adverb is included in the ellipsis, the result is impeccable:

- (23) I was used to Marie's quietly complaining about the food, but I was surprised at Harvey's [quietly complaining about the food].

Sluicing, first identified by Ross (1969), is characterized by elision of everything in a WH Question clause except the fronted WH phrase:

- (24) Somebody broke my favorite glass, and I want to know who [broke my favorite glass].
- (25) They stole some pictures, but which pictures [they stole] isn't clear.

Since the C is generally silent in WHQ clauses, it is not immediately clear what constituent is being elided in examples like (24-25). One possibility (and the one that I will adopt) is that the elided part is a TP, complement of the interrogative C.⁹

As is well known, Sluicing does not apply in Relative Clauses, though their internal syntax looks just like that of WH Question clauses:

⁹The one context in which the C is audible is when the WH clause is a root Question, in which case T->C movement puts something audible in C:

- (i) Which dogs could you see?

And indeed it appears that Sluicing in this case elides the C as well, leading some to conclude that the elidee in Sluicing is C':

- (ii) I could see some dogs. – Oh, yeah? How many dogs [could you see]?

In section 2.4, however, I will argue that (ii) is not, at least not obviously, an instance of sluicing. Consequently, I will assume that Sluicing involves ellipsis of the TP complement of the interrogative C that attracts a WH-phrase to its specifier in WH-questions.

- (26) * Somebody broke my favorite glass, and I plan to kill the person who [broke my favorite glass].

This is unsurprising if Sluicing is licensed by the C[+Q,+WH] of constituent questions, but not by the C[-Q,+WH] of relative clauses. What is surprising is that this should be so in every language and dialect, so this is another one of those cases where we can easily describe an amazing fact, but nobody has figured out why it should be a fact.¹⁰

VPE, NPE, and Sluicing have several properties in common, presenting a sufficiently unified profile that it seems justified to regard them as representatives of a type of ellipsis. Here I will catalogue these common properties. We will see in section 2.2 that not all ellipsis processes share these properties.

Property 1

First, as noted above, each of these processes can be characterized as the elision of the complement of a particular kind of functional head: in the case of VPE, the licensing heads are T (including pres, past, to, and the Modals); Neg (or possibly more generally Sigma or Pol); and the Auxiliary verbs have [PERF], be [PROG], be [PASS], and be [COP]; in the case of NPE, they are D[POSS], D[DEM], and possibly certain quantifiers; in the case of Sluicing, the licensing head is C[+Q,+WH].

The remaining notable properties of these ellipses can be generally characterized as a remarkable insensitivity to structure. They cannot happily go backward (ellipsis site preceding antecedent) in coordinate structures, but no anaphoric processes can do that:

- (27) * I don't [like coffee] and Harvey likes coffee.
 (28) * Either Harvey's [dog] bit Betty or Betty's dog bit Harvey.
 (29) * I know who [stole the emeralds] and it's clear that somebody stole the emeralds.¹¹

¹⁰There is one respect in which Sluicing cannot always simply be the elision of a TP, without some further manipulation. As Ross (1969) observed, when the fronted WH phrase originates as a complement to a P, the P can be apparently stranded by the ellipsis (the phenomenon known as "swiping" (Merchant 2002)):

- (i) She went to the movies, but we don't know who [she went to the movies] with.

An alternative account would be that the P is pied piped in the normal manner along with the fronted +WH DP, and a separate operation reverses the order of P and DP; but there appears to be no independent motivation for that operation, which would have to occur only in PPs fronted by WH movement and then stranded by Sluicing. I won't have anything very interesting to say about this problem, though it does bear on the question of ellipsis as a constituency test.

¹¹One of the several reasons for not classifying but as a coordinator is that it does permit backward ellipsis of this type:

- (i) I don't know who [stole the emeralds], but it's clear that somebody stole the emeralds.
 (ii) I didn't want to [eat the sushi], but I did eat the sushi.
 (iii) Germany's [stock market] went down, but Turkey's stock market rose after the crisis.

This has something to do with the fact that "X but Y" means the same thing as "though X, Y." I'm probably not smart enough to figure this out.

Aside from that, structural relations between the ellipsis site and the antecedent do not seem to matter.

Property 2

These ellipses can go across sentence and speaker boundaries:

- (30) You know I've never ridden a camel. Ivan has [ridden a camel].
- (31) I smelled the camel's breath. You smelled the merchant's [breath].
- (32) A: Somebody stole the emeralds.
B: Do you know who [stole the emeralds]?

Property 3

They are unbounded, in the sense that the antecedent and ellipsis site can be unboundedly far apart in hierarchical structure:

- (33) I've never ridden a camel, but it's pretty clear that we can be sure that Ivan has [ridden a camel].
- (34) If you've smelled a camel's breath, you don't need to be afraid of anyone trying to scare you by making you smell a donkey's [breath].
- (35) Somebody stole the emeralds, and I am sure the police think nobody believes we'll ever find out who [stole the emeralds].

Property 4

In addition to being unbounded, these ellipses are not subject to island constraints (the ellipsis site and the antecedent may be separated by island boundaries):

- (36) I don't carry a cellphone, and people who expect me to [carry a cellphone] are bound to be disappointed.
- (37) I have my own Porsche, so the assumption that I was driving my mother's [Porsche] when I robbed the bank is unjustified.
- (38) They hid something in the trunk of the stolen car, and the only man who knows what [they hid in the trunk of the stolen car] is in a jail in Phoenix.

Property 5

Finally, ellipses of this type can go backward (the ellipsis site can precede the antecedent), as long as it doesn't go backward in a coordinate structure:

- (39) Unless you want me to [mention this to your mother], I won't mention this to your mother.
- (40) Anyone who has seen Peter's [yacht] will not be impressed by Harvey's yacht.
- (41) Nobody knows why [rabbits are gentle creatures], but rabbits are gentle creatures.

Properties 2, 3, 4, and 5 have to do with the relation between an ellipsis site and a potential antecedent. I will call such properties range properties. I will henceforth call ellipses that have these characteristics Type A (or, to anticipate a bit, head-licensed ellipses). In the following subsection I will turn to ellipses that do not share these properties.

2.2 GAPPING, STRIPPING

2.2.1 GAPPING

Gapping has been the subject of substantial investigation (for a selection see Ross 1970, Jackendoff 1971, Hankamer 1973, 1979, Hankamer and Sag 1976, Chao 1988, Jayaseelan 1990, Johnson 2009, and many more), but there is not general agreement about either its extent (some people would object that some of the ellipses that I will attribute to Gapping are in fact something else) or its analysis. The second doesn't really matter for the purposes of this article, and the first will also be irrelevant since if there are several different ellipses involved, they will all be seen to have the properties that distinguish Gapping from the ellipses of type A.

Undisputed examples of Gapping involve the ellipsis of material including T¹² (and usually the main Verb¹³) from all non-initial conjuncts in a coordinate structure, under identity with the corresponding elements in the initial conjunct.

- (42) Sally might have written a book, and Harvey [might have written] a poem.

Despite assertions to the contrary that one finds in the literature (e.g. Toosarvandani 2013) the T does not have to be finite:

- (43) I want Harvey to write a novel, and Bill [to write] a play.
(44) For Harvey to write a novel and Bill [to write] a play would be a real surprise.

It is already clear that Gapping cannot be characterized as elision of a Verb. In fact, as Ross (1970) pointed out, the gap can encompass a large (in principle indefinitely large) amount of stuff:

- (45) I want to try to begin to write a novel, and Bill [wants to try to begin to write] a play.

The elided material, while always including the T (and usually the main V), can apparently include other things as well:

¹²Examples like (iii) make it look like T is not always elided in Gapping:

(iii) Harvey couldn't open the window, but he could [open] the door.

Example (iii), however, is not Gapping, but Pseudo-Gapping, to be discussed more thoroughly in section 2.5. From here on I will continue to assume that Gapping always involves elision of T in the gapped clause.

¹³Examples like (i) indicate that the main Verb is not always part of what is elided:

(i) Sue could have opened the window, and Harvey [could have] closed the door.

The story of this, though, might be more complicated.

- (46) I got sick because I ate too much, and Harvey [got sick] because he drank too much.
- (47) Most of these kids can run a mile in six minutes, and a few [can run a mile] in under five.

Despite the accepted name of the process, the "gap" is not always in the middle:¹⁴

- (48) I lent Louise a dollar, and [I lent] Harvey a dime.
- (49) I told my mother about my fears and [I told] my wife about my hopes.
- (50) The scary noises were persuading Martha that we should go back home and [the scary noises were persuading] me that we should never have come.
- (51) You call my analysis crazy and [you call] yours inspired.

Further, and as will become important later, the elided material does not always constitute a contiguous stretch (at least not in any obvious way):

- (52) Bill bet ten dollars on the fight, and Harvey [bet] five dollars [on the fight].
- (53) Bill put ten dollars on the table, and Harvey [put] five dollars [on the table].
- (54) Mary put rocks in the can, and Betty [put] marbles [in the can].
- (55) He called me an idiot, and I [called] him [an idiot].

I will assume that there is an ellipsis process with the following basic characteristics, and call it "Gapping":

- The ellipsis is confined to coordinate structures, eliding material from non-initial conjuncts under identity with corresponding material in the initial conjunct.
- The elided part includes T.
- The elided part usually also contains a verb, and if it does, it contains everything between T and that verb.¹⁵

¹⁴Some in the GPSG tradition use the term "Left Peripheral Ellipsis" for examples like (48-51); but so far as I am aware, there is no particularly good reason to believe that Left Peripheral Ellipsis and Gapping are not reflections of the same process. For the purposes of the present paper, it will not matter, because as will be shown, if there is a separate process of Left Peripheral Ellipsis, it is in the same family as Gapping in the typology of ellipsis processes.

On the other hand, there is a possibility that these kinds of examples do not involve ellipsis at all, but rather coordination of big VPs as a complement to little v. When the big Vs head-raise across-the-board to little v, the resulting structure is [DP V [DP DP] and [DP DP]], providing the observed pattern with no ellipsis.

This analysis is of course not available for examples like (52-55).

¹⁵Jackendoff (1971, p. 23) noticed this: "Gapping cannot take place if there are unlike auxiliaries ... If the auxiliaries are alike, Gapping must delete the second auxiliary as well as the verb ...". "Gapping cannot tolerate unlike adverbs preceding the verb, either ...".

- The ellipsis leaves two remnants¹⁶ which are contrastive with corresponding parts of the antecedent structure.

2.2.2 STRIPPING

Stripping is a term introduced in Hankamer 1971, 1979 to denote the ellipsis found in fragment answers to WH-questions:

- (56) A: Who did Sally bring to the party?
B: [Sally brought] John [to the party].
- (57) A: Who brought Sally to the party?
B: John [brought Sally to the party].

I assumed then (and still do) that essentially the same process is at work in several other contexts:

- (58) Sally brought Bill to the party, not [Sally brought] John [to the party].
- (59) Sally didn't bring John to the party, but [Sally brought] Bill [to the party].
- (60) Sally brought John to the party, and [Sally brought] Bill [to the party].[FN]

Some sources use the term "Fragment Answer Ellipsis" for the cases in (56-57), and it is conceivable that the differences in context may justify distinct processes for (56-57) and (58-60). As will be seen, though, if there are such distinct processes, they all share the same essential characteristics from a typological point of view. I will proceed to use the term "Stripping" for all of these cases.

Stripping: an ellipsis process (or processes) in which material is elided from a domain (I will call it the target domain) under identity with corresponding parts of an antecedent domain, leaving behind one remnant constituent which contrasts with a corresponding constituent in the antecedent domain.¹⁷

As characterized here, an immediately striking difference between VPE, NPE, and Sluicing on the one hand and Gapping and Stripping on the other is that in cases of Gapping and Stripping there is no obvious head to license the ellipsis, which as we have seen is characteristic of ellipses of type A. As we shall see, Gapping and Stripping (which I will henceforth call type B ellipsis) exhibit starkly different behavior in terms of structure-sensitivity as well.

¹⁶For many speakers, the number of remnants in Gapping must be exactly two. For these speakers (i) is ungrammatical:

- (i) Harvey lent a book to Paul, and Sue [lent] a magazine to John.

Other speakers find (i) perfectly grammatical. When necessary I will refer to the first group as observing a two-remnant constraint on Gapping. One might think that (ii) is Gapping with a single remnant:

- (ii) My oldest daughter went to college, and my youngest [went to college].

I see no reason, however, not to regard (ii) as a case of Stripping, to be discussed immediately below, which always leaves a single remnant.

¹⁷In this paper, I will choose examples in which the antecedent and target domains are clauses, though conceivably Stripping may apply in smaller domains as well.

In one respect type A and type B ellipses are similar: they cannot go backward in coordinate structures (examples repeated from section 2.1):

- (26) * I don't [like coffee] and Harvey likes coffee.
- (27) * Either Harvey's [dog] bit Betty or Betty's dog bit Harvey.
- (28) * I know who [stole the emeralds] and it's clear that somebody stole the emeralds.
- (61) * Harvey [likes] coffee and Mary likes tea.
- (62) * Not [Sally brought] John [to the party], Sally brought Bill to the party.

As observed above, no anaphoric processes can do that.

Otherwise, type B ellipses and type A ellipses are quite different. While type A ellipses are unbounded (cf. examples (33-35)), type B ellipses cannot go into embedded causes:¹⁸

- (63) * Sally might have written a book, and Marie thinks that Harvey [might have written] a poem.
- (64) * I want Harvey to write a novel, and Mary wants Bill [to write] a play.
- (65) A: Who did Sally bring to the party?
B: * Well, she denies (that) [Sally brought] John [to the party].
- (66) A: Who brought Sally to the party?
B: * Well, I doubt (that) John [brought Sally to the party].
- (67) * Sally brought Bill to the party, so we can be pretty sure that not [Sally brought] John [to the party].
- (68) * Sally didn't bring John to the party, so we can be pretty sure that [Sally brought] Bill [to the party].

The antecedent and target domains of Gapping must be directly coordinated. Similarly, the antecedent and target domains of Stripping must be structurally adjacent, with nothing in between except the connective (if there is one) that joins the two domains.

Type A ellipses, as seen in examples (39-41), can go backward; type B ellipses never do:

- (61) * Harvey [likes] coffee and Mary likes tea.
- (69) * Not [Sally brought] John [to the party], but Sally brought Bill to the party.
- (70) * [Sally brought] John [to the party], and Sally brought Bill to the party.

To summarize, there are at least two very different kinds of ellipsis. In type A ellipsis, there is a licensing head whose complement undergoes elision, and this kind of ellipsis is structure-insensitive in that it is unbounded, is insensitive to

¹⁸In these examples, I have been careful to avoid the possibility of a parenthetical interpretation for the material that is intended to force the ellipsis site into an embedded context.

island constraints, and can go backward. In type B ellipsis, the elided material cannot be characterized as the complement of any particular licensing head, and type B ellipsis is very sensitive to structure: the antecedent and target domains must be directly in construction with each other, and the antecedent must precede. The range properties of the two types of ellipsis are radically distinct. Type B ellipses do not share any of the distinctive properties (properties 1-5) of type A ellipses.

2.3 AN INSTRUCTIVE CONTRAST: POLARITY STRIPPING AND POLARITY ELLIPSIS

Depiante (2004) investigates ellipses in Spanish involving a polarity morpheme and one remnant, exemplified in (71-72), and argues persuasively that two different ellipsis processes are involved, based on their properties. In (x) it is a type A ellipsis and in (y) it is type B.

(71) Juan vio a Maria, pero a Susana no.
'John saw Mary, but not Susan.'

(72) Juan vio a Maria, pero no a Susana.
'John saw Mary, but not Susan.'

The evidence is that when the remnant precedes the polarity morpheme, the ellipsis is unbounded, is insensitive to islands, and can go backward, as shown in (73-76)a:

(73) a. Susana leyó el dictamen pero Maria dijo que Juan no.
'Susan read the report but Mary said that John didn't.'

b. * Susana leyó el dictamen pero Maria dijo que no Juan.

(74) a. Juan juega al tenis todos los fines de semana, y creo que Susana dijo que Pedro piensa que Maria no.
'John plays tennis every weekend, and I think that Susan said that Pete thinks that Mary doesn't.'

b. * Juan juega al tenis todos los fines de semana, y creo que Susana dijo que Pedro piensa que no Maria.

(75) a. Juan no entregó el trabajo a tiempo, pero existe el rumor que Maria sí.
'John didn't turn in the homework on time, but there's a rumor that Mary did.'

b. * Juan no entregó el trabajo a tiempo, pero existe el rumor que sí Maria.

(76) a. Jorge sí, pero Maria Laura no tiene una gata.
'George does, but Mary Laura doesn't have a cat.'

b. * Sí Jorge, pero Maria Laura no tiene una gata.

When the remnant follows the polarity morpheme, the ellipsis is bounded and cannot go backward, as seen in (76b). Depiante makes sense of this, in terms of the typology of ellipsis developed here, by analyzing examples like (71) as a type A ellipsis licensed by the polarity morpheme. The remnant is moved to the front by an independently necessary topicalization, and the complement of the polarity head, minus the extracted constituent, is elided under identity with the antecedent clause. In examples like (72), a process equivalent to Stripping applies, and everything except the polarity head and the remnant is elided by a type B process. The point of this example is that it is not always obvious, on superficial inspection, what kind of ellipsis you are dealing with. To know that, some non-trivial analysis might be necessary. At the end of this paper, I will argue that you have to know what type of ellipsis you are dealing with before you can use it as a diagnostic for constituency.

2.4 ANOTHER USEFUL RESULT

One of the mysteries of the Sluicing construction is that (on occasion) it seems to elide a bar-level constituent (a C-bar), which would be unique among ellipsis processes, and indeed hard to find among processes in general. The crucial cases are like (77), repeated from section 1:

- (77) I could see some dogs. – Oh, yeah? How many dogs [could you see]?

It is important to notice, however, that this apparent sluicing of a C-bar can only occur in root clauses, since that is the only environment in which the element in T can have moved to C. In this context, however, it is perfectly plausible that the ellipsis observed is due to Stripping, and not to Sluicing.

2.5 PSEUDOGAPPING AND N-PSEUDOGAPPING

2.5.1 PSEUDOGAPPING

Pseudogapping (Levin 1986, Jayaseelan 1990, Lasnik 1999) is like VP-ellipsis with a remnant:

- (78) I wouldn't trust her, but I would [trust] her mother.
 (79) He wouldn't feed the pigs rat poison, but he might [feed] the kittens [rat poison].

Pseudogapping, like VPE (and unlike Gapping) is dependent on the presence of a licensing head adjacent to the ellipsis site. Just like VPE, it is licensed by elements in T (present, past, Modals) and Auxes. Like VPE, Pseudogapping is impossible when an adverb intervenes between the licensor and the ellipsis domain, or when there is no licensor:

- (80) *The kid will eat cauliflower, but he will never [eat] cabbage.

- (81) * You might catch him playing video games, but you won't catch him [playing] cards.

Levin (1986) observed that one T that does not license Pseudogapping is the infinitival 'to':

- (82) * While I'm willing to kiss Sue, I don't want to [kiss] Louise.

It also appears that Neg doesn't license Pseudogapping:

- (83) * You can eat the shrimp, but you had better not [eat] the mussels.
(84) * You can put the gold coins in the box, but I would prefer that you not [put] the jewels [in the box].

This makes me suspect that in (85) the licenser might be the T, to which Neg has adjoined.

- (85) I'll feed the horses, but I won't [] the pigs.

I will consequently assume that Pseudogapping is to be characterized as the elision of most of a complement of a licensing head (present, past, Modals, and Auxes), stranding one remnant which is contrastive with a corresponding element in the antecedent.

Since Pseudogapping appears to be ellipsis of (most of) the complement of a licensing head, we might expect it to pattern in terms of its range properties like type A ellipsis, and to some extent it does. Pseudogapping is not confined to coordinate structures or any particular kind of surrounding structure, and can go into embedded clauses.¹⁹ In this it is entirely unlike Gapping and Stripping:

- (86) Mary likes Bill, although she doesn't [like] Harry.
(87) Although I can't wiggle my toes, I can [wiggle] my ears.
(88) Mary hasn't dated Bill, but it is well known that she has [dated] Harry.

¹⁹It has long been believed (since Levin 1986) that Pseudogapping cannot go backward, since backward examples of Pseudogapping compare quite poorly with backward VPE:

- (i) Someone who can't [wiggle his ears] should just watch me wiggle my ears.
(ii) *Someone who can't [wiggle] his toes should just watch me wiggle my ears.

Jason Merchant (p.c.), however, discovered the following example:

- (iii) "As one does the return of sun after winter, I stood still and accepted the warm glow of possibility, of feeling right in the company of this small, oddly fierce person with the inky hair and the lovely, unemphasized body." (Jeffrey Eugenides, *Middlesex*, 2002, Picador: New York, p. 233)

I am not convinced that this is grammatical; not everyone who tries to be elegant in writing English succeeds in doing it grammatically. If it is to be regarded as grammatical, it remains mysterious why good examples of backward Pseudogapping are so hard to find.

In summary, Pseudogapping shares more properties with VPE than it does with Gapping: it is head-licensed, involves the elision of (most of) the complement of the licensing head, and has most of the range properties of a type A ellipsis. In particular, it is not confined to coordinate (or any other) structures, has unbounded range, and is not sensitive to islands. As with many things in linguistics, it is badly named.

2.5.2 N-PSEUDOGAPPING

We can find something like Pseudogapping in the nominal domain. Jackendoff (1971) exhibited examples like (89-90), and called them "N-gapping":

- (89) Harry's wines from France and Bill's [wines] from Italy
- (90) Harry's stories about fishing and Bill's [stories] about hunting

In the light of a more modern analysis of nominal structure, however, Jackendoff's "N-gapping" examples don't look very much like Gapping at all. First, Gapping in the clausal domain always elides the T head; in (89-90), the corresponding head would be the D[poss], which is not elided.²⁰ Second, and most revealingly, "N-gapping" does not require the antecedent and target domains to be adjacent, and they do not have to be coordinated:

- (91) I didn't taste Harry's wines from France but I did taste Bill's from Italy.
- (92) Harry's stories about fishing were more interesting than Bill's [stories] about hunting.
- (93) While I don't think I've heard Harry's stories about fishing, I'm quite sure I have heard Bill's [stories] about hunting.

The examples above show that this ellipsis process is not confined to coordinate structures and indeed not restricted to any particular kind of syntactic environment; that it can cross sentence and speaker boundaries and can go into embedded clauses; and that it is not affected by island constraints. It has, in short, most of the properties of a type A ellipsis process. It is, to be sure, not very good going backward:

- (94) * While I haven't tasted Harry's [wines] from France, I have tried Bill's wines from Italy.
- (95) * While I don't think I've heard Harry's [stories] about fishing, I'm quite sure I have heard Bill's stories about hunting.

In this it is very like Pseudogapping.

These properties make Jackendoff's "N-gapping" look a lot more like a type A ellipsis than a type B ellipsis. The resemblance to Gapping is the stranding of

²⁰Unless, of course, the D[poss] is silent and the -'s morpheme is a genitive case marker. The range behavior, in any case, makes it very clear that this process is not to be assimilated to Gapping.

an extra remnant in addition to the possessor DP. I propose that this is not an instance of Gapping in the nominal domain but rather the nominal equivalent of Pseudogapping. I will consequently call it N-pseudogapping. Like Pseudogapping, N-pseudogapping elides most of the complement of a licensing head, except for one constituent which survives as a remnant.

2.6 COMPARATIVE ELLIPSIS

In this section I will briefly discuss an ellipsis process that is peculiar to comparative clauses, called (following Bresnan 1973) Comparative Ellipsis. CE is to be distinguished from the A-bar process that produces an obligatory gap²¹ in a comparative clause:

- (96) We picked more apples than we could carry [o] in the wheelbarrow.
 (97) We picked more apples than [o] would fit in the wheelbarrow.

Bresnan attributed this kind of gap to a process she called "Comparative Deletion". The standard assumption since Chomsky (1976) is that such gaps result from A-bar movement of a silent operator from the gap site to the specifier of the comparative clause. The particular mechanism will not concern us here, since we are interested in a further possibility of omission of material, a genuine ellipsis this time, called Comparative Ellipsis, which is exhibited in (99):²²

²¹I assume, still following Bresnan (1973), that there is a gap in the indicated position in examples like (i):

- (i) The table is longer than the door is [o] wide.

Bresnan called the process producing this gap "Subdeletion". I actually believe this is the same process as Comparative Deletion, but that is a matter for another paper.

²²CE is not the only ellipsis process that can apply in comparative clauses. VPE (of the antecedent-contained variety) can occur, as well as Pseudogapping:

- (i) They ate more pancakes than we thought they would [eat [o]].
 (ii) They order pancakes more often than they do [order] omelettes.
 (iii) We liked the pancakes more than we did [like] the omelettes.
 (iv) They liked the sausages just as much as we already knew they did [like] the bacon.

Another phenomenon that is found in Comparative clauses and must be distinguished from Comparative Ellipsis is the apparent ellipsis of whole CPs as in (v)-(vii):

- (v) She's younger than you think [she is].
 (vi) They brought more chairs than [] was necessary.
 (vii) They brought more chairs than we thought [] was necessary.

That is not Comparative Ellipsis, but rather an effect that I have elsewhere called Pied Wiping: the ellipsis of a constituent containing the gap of an A-bar construction. Evidence that it is not Comparative Ellipsis lies in the fact that this phenomenon has Type A properties: it can apply into embedded clauses and is unbounded.

In these cases, as with VPE and Pseudogapping in general, the elided material consists of the complement one of the appropriate licensing heads (except for a remnant constituent in the case of Pseudogapping). In what I call CE, the elided material is not related to any (obvious) head, and (as we shall see) CE has very different properties from VPE and Pseudogapping.

- (98) Martha peeled more apples than Harry peeled [o]. [CD]
 (99) Martha peeled more apples than Harry [peeled [o]]. [CE]

Note that CD, where possible, is obligatory; CE, on the other hand, is always optional, as is expected of an ellipsis process.

What sort of ellipsis process is CE? First let us note that CD, like other A-bar processes, is unbounded, though it obeys island constraints:

- (100) We picked more apples than the bosses thought we could carry [o] in the wheelbarrow.
 (101) *We picked more apples than the boss hired a man to carry [o] in the wheelbarrow.

While we are checking things, note also that VPE and Pseudogapping within comparative clauses are unbounded just as expected:

- (102) They ate more pancakes than we thought they would [eat [o]].
 (103) They order pancakes more often than they do [order] omelettes.
 (104) We liked the pancakes more than we did [like] the omelettes.
 (105) They liked the sausages just as much as we already knew they did [like] the bacon.

CE, however, is not at all unbounded:

- (106) Martha peeled more apples than we thought Harry peeled [o].
 (107) *Martha peeled more apples than we thought Harry [peeled [o]].

CE is a type B ellipsis, like Gapping and Stripping. It elides everything in a comparative clause that is identical to corresponding material in the matrix clause, except for one contrasting element that survives as a remnant. I am not sure why the following is true, but it is: Gapping, Stripping, and CE always elide T and V (and everything in between). This is why CE cannot elide a subject, stranding a tensed V:

- (108) Objects in mirror are closer than *(they) appear.

T must be elided, so there is no way for 'appear' to get tense. This probably needs more investigation.

Comparative Ellipsis elides parts of a comparative clause, always including the T, that are identical with corresponding parts of the matrix clause, always leaving one remnant. It has the range properties of a type B ellipsis.

2.7 CONCLUSION

In this section I have established that there is a typology of ellipsis processes, with at least two major types. Type A, which could be called head-licensed ellipsis, involves the ellipsis of the complement of a licensing head, with the possibility of a single remnant surviving the ellipsis. Since the licensing head can sometimes be silent, its overt presence cannot be used as a secure diagnostic. Type B ellipsis does not involve the elision of the complement of any particular head, but it does involve the elision of a head (T in the case of Gapping, Stripping, and Comparative Ellipsis), together with other material, leaving behind one or two remnants. The two types of ellipsis differ radically in their range properties: type A ellipses are unbounded, insensitive to island constraints, and can go backward. Type B ellipses are very sensitive to syntactic environment, are always bounded in the sense that the ellipsis site must be in a domain that is linearly adjacent to the antecedent domain, with at most a coordinator or a complementizer intervening, are therefore bounded, and cannot go backward. I have no theory about why there should be two types, or why the head-licensed type should sometimes permit a remnant. I am sure, though, that these types exist, and that there are few if any other types.

3 REMNANT MOVEMENT ANALYSIS

There have been various attempts (Jayaseelan (1990), Lasnik (1999), Johnson (2000, 2009)) to analyze some of the phenomena that I have categorized as Type B ellipsis as actually involving the elision of a constituent. These analyses all involve the assumption that the remnants surviving after the ellipsis have been previously moved out of the constituent to be elided. It will be a matter for another paper to demonstrate that these analyses all fail. They fail because either the proposed movements are unmotivated or because the proposed movements, if assumed to be some motivated movement, cannot have the properties that the motivated movements are known to have. I would love to demonstrate that here, but time and space have run out. What should be clear, though, is that if an ellipsis process can only be analyzed as eliding a constituent under the assumption that the ellipsis domain is a constituent only by virtue of things having been moved out of it, the ellipsis cannot be used as a diagnostic for constituency of the *apparently* elided part, since that part will not ordinarily be a constituent.

4 CONCLUSION

The conclusion is that Ellipsis is not a test for constituency unless you know what kind of ellipsis it is. If you know that an ellipsis is the result of a type A (i.e. head-licensed) process, you can safely conclude that the stuff elided by that process is either a constituent or a constituent minus a remnant (so you can conclude that the gap + remnant is a constituent). If the stuff is elided by a type B process, it

appears that the *remnants* are always constituents, but the elided portion is generally not. In fact, I suspect it is *always* not, because type B processes always elide the head of the ellipsis domain, and as far as I can tell they always also elide something else. In other words, there seems to be no ellipsis process that only elides a simple head. Here is a place where the theory of ellipsis should tell us why things are the way they are.

REFERENCES

- Aoun, J. and Benmamoun, E. (1999). Gapping, PF merger, and patterns of partial agreement. In Lappin, S. and Benmamoun, E., editors, *Fragments: Studies in Ellipsis and Gapping*, chapter 175–192. Oxford University Press.
- Bresnan, Joan. 1973. 'Syntax of the comparative clause construction in English.' *Linguistic Inquiry* 4.3, 275–343.
- Bresnan, Joan. 1975. 'Comparative deletion and constraints on transformations.' *Linguistic Analysis* 1(1), 25–74.
- Chao, Wynn (1988) *On Ellipsis*. Garland Press. (Outstanding Dissertations in Linguistics)
- Cheng, Hsu-Te (2013) *Argument Ellipsis, Classifier Phrases, and the DP parameter* (U Conn Dissertation)
- Chomsky, Noam 1976 "On Wh-Movement". *Linguistic Inquiry*
- Chung, Sandra, William Ladusaw, and James McCloskey (1995) "Sluicing and Logical form". *Natural Language Semantics* 3.3: 239-282.
- Chung, S., W. Ladusaw, and J. McCloskey. 2011. *Sluicing: Between Structure and Inference*. In *Representing Language: Essays in Honor of Judith Aissen*.
- Culicover, Peter 2009. *Natural Language Syntax*. Oxford University Press.
- Culicover, Peter and Ray Jackendoff. 2005. *Simpler Syntax*. Oxford University Press.
- Depiante, Marcela (2000) *The Syntax of Deep and Surface Anaphora: A Study of Null Complement Anaphora and Stripping/bare argument ellipsis*. PhD Dissertation, University of Connecticut
- Depiante, Marcela (2004) "Dos casos de elipsis con partícula de polaridad en Español: Evidencia a favor de una vision no uniforme de la elipsis." *RASAL Lingüística* 1: 53-69.
- Hankamer, Jorge (1979) *Deletion in Coordinate Structures*. Garland.
- Hankamer, Jorge and Ivan Sag 1976 *Deep and Surface Anaphora*. *Linguistic Inquiry*
- Jackendoff, Ray 1971 "Gapping and Related Rules", *Linguistic Inquiry*, Vol. 2, No. 1, pp. 21-35.
- Jayaseelan, K. A. 1990 "Incomplete VP Deletion and Gapping", *Linguistic Analysis* 20.1-2, pp. 64- 81.
- Johnson, Kyle. 1996. *In search of the English middle field*. Ms., University of Massachusetts, Amherst.

- Johnson, Kyle 2000 "Few dogs eat Whiskas or cats Alpo," in University of Massachusetts Working Papers in Linguistics, (eds.) Kusumoto, Kiyomi and Elisabeth Villalta, 47–60.
- Johnson, Kyle. 2001. What VP-ellipsis can do, what it can't, but not why. In Mark Baltin and Chris Collins (eds.), *The handbook of contemporary syntactic theory*, 439– 479. Blackwell:
- Johnson, K. 2009. Gapping is not (VP) ellipsis. *Linguistic Inquiry* 40, 2, 289–328.
- LaCara 2010 Verbal Ellipsis in the Nominal Domain. MA Thesis, University of California at Santa Cruz.
- Lappin, Shalom, and Elabbas Benmamoun 1999, *Fragments: Studies in Ellipsis and Gapping*. Oxford University Press.
- Lasnik, H. 1995. "A note on pseudogapping". *MIT Working Papers in Linguistics* 27: 143–163.
- Lasnik, H. 1999. "Pseudogapping puzzles". In S. Lappin and E. Benmamoun (eds.) *Fragments: Studies in Ellipsis and Gapping*. Oxford University Press, pp. 141–174.
- Levin, Nancy 1986 *Main Verb Ellipsis in Spoken English*. *Outstanding Dissertations in Linguistics*. Garland.
- Lobeck, Anne. 1991. The phrase structure of ellipsis. In Susan Rothstein (ed.), *Perspectives on phrase structure*, 81–103. Academic Press: San Diego.
- Lobeck, Anne. 1995. *Ellipsis: Functional heads, licensing, and identification*. Oxford University Press: Oxford.
- Merchant, Jason. 2001. *The syntax of silence: Sluicing, islands, and the theory of ellipsis*. 2001. Oxford University Press: Oxford.
- Merchant, Jason. 2002. "Swiping in Germanic", in C. Jan-Wouter Zwart and Werner Abraham (eds.), *Studies in Comparative Germanic Syntax*, 295–321. John Benjamins, Amsterdam.
- Miller, Philip. 1990. "Pseudo-gapping and do so substitution". *Proceedings of the 26th Meeting of the Chicago Linguistic Society*, 293–305.
- Morris, Amanda (2008) *Polarity Ellipsis and Negative Stripping*. MA Thesis, University of California at Santa Cruz.
- Ross, John R. 1969. Guess who? In Robert Binnick, Alice Davison, Georgia Green, and Jerry Morgan (eds.), *Papers from the 5th regional meeting of the Chicago Linguistic Society*, 252–286. Chicago Linguistic Society: Chicago, Ill.
- Ross, John 1970. Gapping and the order of constituents. In *Progress in linguistics: A collection of papers*, M. Bierwisch and K. Heidolph (eds.), 249–259, The Hague: Mouton.
- Sag, Ivan and Jorge Hankamer (1984) "Toward a theory of anaphoric processing", *Linguistics and Philosophy* 7: 325–345.
- Toosarvandani, Maziar (2013) *Gapping is low coordination (plus VP-ellipsis): A reply to Johnson*. Massachusetts Institute of Technology June 11, 2013.
- Zagona, Karen 1982 *Government and Proper Government of Verbal Projections*. PhD Dissertation, University of Washington.

Matching Light Elements

Junko Ito and Armin Mester
University of California, Santa Cruz

1 INTRODUCTION

Our goal here is to investigate the impossibility of phrase-final prosodic enclisis in English, as in (1a) vs. (b).¹

- (1) a. *I don't know where Tom's. (I don't know where Tom is.)
 b. Where's Tom? (Where is Tom?)

Familiar as it is, this fact is still surprising since $\omega(\textit{Tom's})$ looks like a *bona fide* prosodic word, just like $\omega(\textit{where's})$. It should therefore be wellformed in any position, including phrase-final, as is the homophonous possessive in the utterance *This book is Tom's*. The explanation we will pursue here builds on the basic fact that, because of wh-movement, $[\textit{is/'s}_\]$ constitutes an entire syntactic phrase, and as such must correspond to a non-vacuous phonological phrase.

The impossibility of phrase-final enclisis needs to be seen in the context of the whole system of cliticization of English. The simple non-vacuity explanation turns out to have important consequences for Match Theory (Selkirk 2011; Elfner 2012; Ito and Mester 2013) since it motivates a conception of Syntax-Prosody (SP)-Match constraints that is rather different from the generally accepted one. The new conception is purely existential and non-gradient, insisting merely on the existence of some corresponding prosodic constituent, not on exact correspondence. The latter is enforced by other constraints that are already part of the theory, such as classical syntax-prosody Alignment and standard faithfulness, evaluated gradiently.

We start out with one class of English function words, including monosyllabic determiners, auxiliaries, and prepositions (2), that forms proclitic structures. Possible mappings to prosodic structure are given in (3) (Selkirk 1996; Ito and Mester 2009), where " σ " stands for "syllable", " ω " for "prosodic word", and " φ " for "phonological phrase". Peperkamp (1997) shows that all of (3b-d) are instantiated in Italian dialects.

¹ We are very pleased to contribute this paper to a festschrift in honor of Jim McCloskey, a friend and colleague of many years. Most of the work we have done on syntax-prosody matters took place in close collegial contact with him, it would not have come into existence without his input. We wish him many more years of productive research. Many thanks to the festschrift editors, and to Nick Kalivoda and Lisa Selkirk for productive discussion. We are especially grateful to Line Mikkelsen for her thorough and helpful comments on an earlier version.

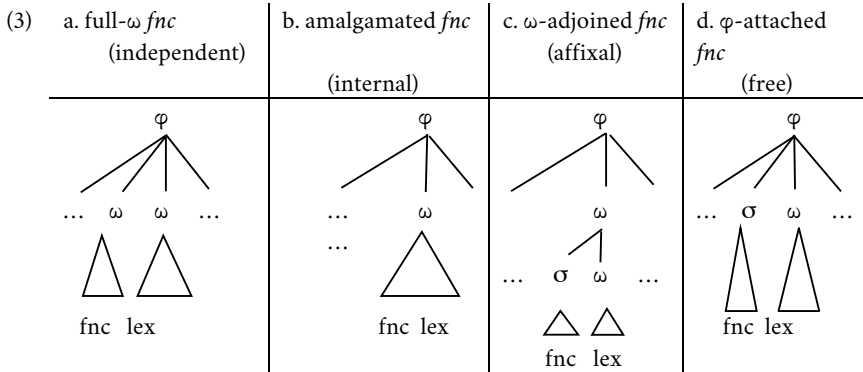
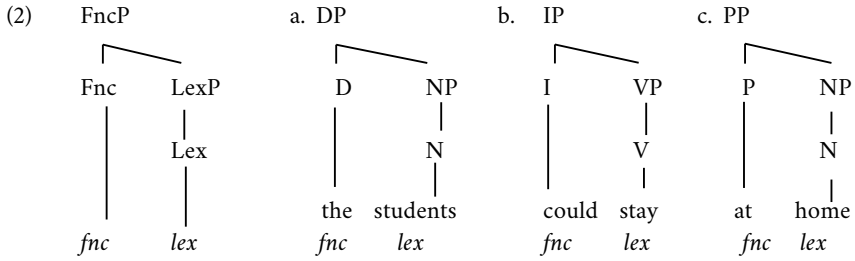

Two views regarding the prosodic structure of English proclitics have been proposed. The majority of researchers (including (McCarthy 1993; Booij 1996; Vigário 1999; Ito and Mester 2007; 2009) argues that they are affixal clitics (3c). The other view (Selkirk 1996; Hall 1999) identifies them as free clitics (3d). The two different structures are contrasted in (4ab).

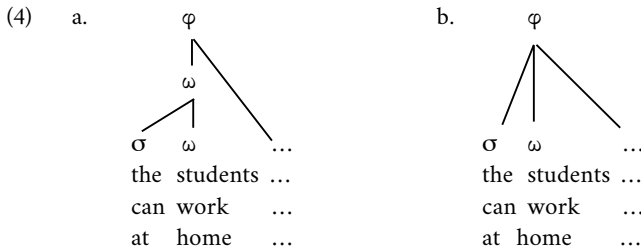

2 REQUIREMENTS ON LEFT EDGES

The phonology of enclisis is part of the overall process of syntax-prosody mapping, where the beginnings and ends of constituents are of special importance. The basic constraints on the correspondence between syntactic and prosodic phrasing are given in (5) in two forms, following Alignment Theory (McCarthy and Prince 1993; Selkirk 1996) and Match Theory (Selkirk 2011), where "CON" stands for "constraints" and "X" for "lexical category".

(5)		<i>Alignment version</i>	<i>Match Theory version</i>
	SP-Mapping	WordCon	Align-L/R (X, ω)
		PhraseCon	Align-L/R (XP, φ)
	PS-Mapping	PWdCon	Match- ω -to-X
		PPhraseCon	Match- φ -to-XP

Since the beginnings of metrical phonology it has been known that left edges of prosodic constituents are subject to more stringent requirements than right edges. An example is the initial dactyl requirement in English (Prince 1983, 49): feet/stresses are right-aligned, but words beginning with unfooted/unstressed syllables are avoided: (*Tàta*)*ma*(*góuchi*), not **Ta*(*tàma*)(*góuchi*). Recently, Selkirk (2011, 470) has proposed STRONGSTART, a generalized version of this kind of left edge requirement (informally: "Beginnings of prosodic units are strong."). STRONGSTART is responsible for a wide variety of prosodically motivated effects. The first is promotion of the initial constituent of the utterance, as in Xitsonga, where preposed constituents which would normally be parsed as phonological phrases are boosted into full intonational phrases (see Kisseberth 1994 for the original empirical generalizations; Selkirk 2011, 442–445). On the other hand, clitics are often banned from first position and appear in peninitial second position (Wackernagel 1892), or are moved to a position later in the sentence, as in Bulgarian (Harizanov 2014) and Irish, as illustrated in (6) (from Bennett, Elfner, and McCloskey 2016:171).

- (6) Fuair sé óna dheartháir an lá cheana é.
- get.PAST he from.his brother the-other-day it
- 'He got it from his brother the other day.'

Another mode of resolution is deletion of initial weak syllables, as in English and German (7).

(7) a. English (Weir 2012)	Have you got milk?	It is a nice day today.
b. German ("pronoun zap", Ross 1982; Haider 1986)	Ich hab das schon gelesen '(I) have already read it'	Das hab ich schon gelesen. '(that) have I already read'

There are even modes of resolution deeply embedded in the morphosyntactic system, such as redundant agreement to create a branching first constituent (cf. Elordieta 2007), or the morphosyntactically unmotivated doubling of agreement clitics, such as the initial masculine clitic *rà* in (8), on unary initial constituents discovered by Ostrove (2016) in a dialect of Mixtec.

- (8) *rà*=estudiante *rà*=Juán
 M=student M=Juán
 'Juán is a student.'

A number of different versions of STRONGSTART have appeared in the literature. Bennett et. al. (2016, 198) state the constraint as a direct ban on prosodic dependents as initial immediate daughters: "Prosodic constituents above the level of the word should not have at their left edge an immediate subconstituent that is prosodically dependent. For our purposes here, a 'prosodically dependent' constituent is any prosodic unit smaller than the word." Selkirk's original formulation takes its inspiration from Myrberg's EQUALSISTERS constraint (Selkirk 2011, 470; see Myrberg 2010; 2013): $*(\pi_n \pi_{n+1} \dots$ "A prosodic constituent optimally begins with a leftmost daughter constituent which is not lower in the prosodic hierarchy than the constituent that immediately follows." The approach most in line with classical OT derives STRONGSTART effects from downward P-to-P-alignment: ALIGN-L (π_n, π_{n-1}) (see Ito and Mester 1992, 56; McCarthy and Prince 1993, 83), a well-known family of constraints requiring strict succession in the prosodic hierarchy at the beginnings of prosodic units (φ to ω , ω to f , etc.). This is the approach taken in Werle (2009), who develops an extensive analysis of peninitial clitics in Bosnian, Serbian, and Croatian along these lines.

The choice is of little import for our purposes, but it is worth noting the consequences of any particular choice for the rest of the theory. For example, the EQUALSISTERS version rules out $[\omega \sigma f$ but is silent on $[\omega \sigma \sigma f$. This is contrary to what is suggested by the facts of English: $[\omega \sigma f$ is abundantly attested in cyclic secondary stress cases such as *sen(sàtio)(náli)ty*, but not $[\omega \sigma \sigma f$. A second point is that the free clitic representation of proclitics in (9b) violates STRONGSTART in any of its versions at the φ -level since the first immediate subconstituent of φ (boxed) is a free syllable. This is problematic since it predicts languages where a DP beginning with a determiner can never start a phonological phrase.

(9) a. affixal:
 ω -adjoined *fnc*

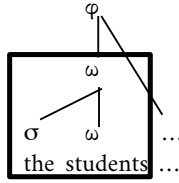

b. free:
 ϕ -attached *fnc*

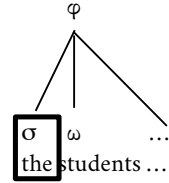

3 NO WEAK PHRASE-FINAL *fnc*

Before we are ready to confront our main topic, the ungrammaticality of final enclisis in English (**I don't know where Tom's*, etc.), we need to address a closely related additional fact: the ungrammaticality of reduced *fnc* in phrase-final position, illustrated in (10) (examples after Selkirk 1996, 2000).

- | | | | | |
|---------|---|-------|--------|-------|
| (10) a. | I can eat more than Ray <i>can</i> . | [kæn] | *[kən] | *[kn] |
| b. | If you think you <i>can</i> , go ahead and do it. | [kæn] | *[kən] | *[kn] |
| c. | I don't know where Ray <i>is</i> . | [ɪz] | *[əz] | *[z] |
| d. | Wherever Ray <i>is</i> , he's having a good time. | [ɪz] | *[əz] | *[z] |
| e. | What did you look <i>at</i> yesterday? | [æt] | *[ət] | |
| f. | Who did you do it <i>for</i> that time? | [fɔr] | *[fr] | |

Selkirk (1996, 202) translates the observations in (10) directly into a constraint: ALIGN-RIGHT(ϕ, ω), requiring every phonological phrase to end in a prosodic word (and not in a prosodically deficient function word). The effect of this is shown in (11).

- (11) [What did Mary [_{VP} look [_{PP} at _]_{VP} last time]
 (ϕ What did Mary look (ω at) ω) ϕ (ϕ last time) ϕ

As seen in (12), Alignment crucially dominates the PS-constraint requiring every prosodic word to be grounded in a lexical word (we use the general label PWDCON since the choice between ALIGNMENT and MATCH is not relevant here). "W/L" in a loser-row indicates that the constraint favors the winner/loser, respectively.

(12)	What did Mary	[look at ___]	Align-R(φ, ω)	PWdCon(ω, x)
	▶	$\varphi(\omega \text{look } \omega \text{àt })$		*
		$\varphi(\omega \text{look } \omega \text{ət })$	*W	L
	I don't know where	[Ray is ___]	Align-R(φ, ω)	PWdCon(ω, x)
	▶	$\varphi(\omega \text{Ray } \omega \text{ìs })$		*
		$\varphi(\omega \text{Ray } \omega \text{əs })$	*W	L
	I can eat more than	[Ray can ___]	Align-R(φ, ω)	PWdCon(ω, x)
	▶	$\varphi(\omega \text{Ray } \omega \text{càn })$		*
		$\varphi(\omega \text{Ray } \omega \text{cən })$	*W	L

ALIGN-R(φ, ω) encourages full prosodification at constituent ends, and as such sits uneasily not so much with STRONGSTART in any of its versions, but with NONFINALITY and other constraints (such as Spaelti's (1994) FINALWEAKEDGE) that favor prosodically weak ends of constituents. Align-R sounds a strangely discordant "StrongEnd" note. It is therefore of some interest that "StrongEnd" is unnecessary in Revised Match Theory (Elfner 2012; Ito and Mester 2013; Bennett et al. 2016): MATCH-PHRASE applies to any XP with phonetic content, matching all XPs with φ 's, with the result that recursive φ -structure emerges as the winner.

(13)	What did	$\text{pp}[at \text{ ___}]$	Headedness	Match-Phrase	PWdCon
	Mary	$\text{vp}[\text{look } \text{ ___}]$			
	▶	$\varphi(\omega \text{look } \varphi(\omega \text{àt })$			*
		$\text{t })$			
		$\varphi(\omega \text{look } \varphi(\omega \text{ət })$	*W		L
		$\text{t })$		*W	*
		$\varphi(\omega \text{look } \omega \text{ət })$		*W	L

MATCH-PHRASE requires a φ to match $\text{pp}[at \text{ ___}]$; HEADEDNESS requires the lone *at* in a φ to be a full prosodic word (violating PWDCON); the choice of the strong allomorph of the function word therefore follows from Match Theory itself; no recourse is needed to any "StrongEnd" (right-alignment) constraint.

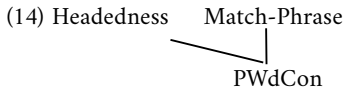

In conformity with the Inclusiveness Condition of Bare Phrase Structure (Chomsky 2007; 2008; 2013), we assume that there are no distinctions of bar levels in syntactic representations, hence no T'/T" distinction in (15).

(15) I can eat more than [_TMichelle [_T can ___]].

The most natural interpretation of Match constraints then is one that applies them to all projections, including auxiliary-verb structures such as *can eat* that are "intermediate projections" of T in traditional understanding. In order to stay with familiar terminology, we refer to all projections of X as "XP", making no distinctions in bar level.

	I can eat more than	TP[DP [Michelle can__]]	Headed- ness	Match- Phrase	PWd Con
	▶	$\varphi(\varphi(\omega\text{Michelle}) \varphi(\omega\text{c}\grave{\text{a}}\text{n}))$			*
		$\varphi(\omega\text{Michelle}) \varphi(\omega\text{c}\grave{\text{a}}\text{n})$		*W	*
		$\varphi(\varphi(\omega\text{Michelle}) \varphi(\omega\text{c}\grave{\text{a}}\text{n}))$	*W		L
		$\varphi(\omega\text{Michelle} \omega\text{c}\grave{\text{a}}\text{n})$		**W	*
		$\varphi(\omega\text{Michelle} \omega\text{c}\grave{\text{a}}\text{n})$		**W	L

The recursive structure $\varphi(\varphi(\textit{Michelle}) \varphi(\textit{can}))$ wins over the flat structure $\varphi(\textit{Michelle}) \varphi(\textit{can})$ because it matches the higher TP with a φ . One might argue that the nonapplication of the rhythm rule (*Michèlle càn*, not **Michelle càn*) favors the flat structure, but this is not probative if the domain is in fact φ_{\min} (see Elordieta 2015; Selkirk and Lee 2015 for recent overviews of recursive category structure in phonology).

	I don't know where	TP[DP [Ray is__]]	Headed- ness	Match- Phrase	PWd Con
	▶	$\varphi(\varphi(\omega\text{Ray}) \varphi(\omega\text{is}))$			*
		$\varphi(\omega\text{Ray}) \varphi(\omega\text{is})$		*W	*
		$\varphi(\varphi(\omega\text{Ray}) \varphi(\omega\text{is}))$	*W		L
		$\varphi(\omega\text{Ray} \omega\text{is})$		*W	*
		$\varphi(\omega\text{Ray} \omega\text{is})$		*W	L

	Compare: Tim is leaving	TP[is leaving]]	Headed- ness	Match- Phrase	PWd Con
	▶	$\varphi(\varphi(\omega\text{Tim}) \varphi(\omega\text{is leaving}))$			
		$\varphi(\omega\text{Tim}) \varphi(\omega\text{is leaving})$			*
		$\varphi(\omega\text{Tim} \omega\text{is leaving})$		*W	

The take-home question here is: Are there cases where Align-R(φ, ω) ("StrongEnd") is actually needed in English and elsewhere—because the function word does not constitute a syntactic XP all by itself?

as an enclitic object	vp[see-PRO DP[___]]	Headed-	Match-	PWd
	$\varphi(\omega\text{see } \omega y \delta u)$	ness	Phrase	Con
▶	$\varphi(\omega\text{see } \sigma ya)$			*W

Summarizing so far, English has a large number of prosodic proclitics (*fncl*): *to go*, *the student*, *can meet*, etc. There is a small number of specific morphosyntactic enclitics (*lex fncl*) which can occur in any position, including phrase-finally, but are restricted as to their host, which has to be verbal: see *ya* (V-obj pro, enclitic to verb). What remains is prosodic enclisis, which is not morphosyntactically restricted to hosts of a specific category, but which cannot occur in phrase-final position (**Tell me where Tom's*).

5 PROSODIC ENCLITICS

English has half a dozen special forms of auxiliaries that show enclisis, as in (21). Different from the morphosyntactically enclitic pronouns seen in the previous section (*ya*, *əm*, etc.), the enclitic auxiliaries listed in (22) are single consonants and hence subsyllabic, and they do not have a morphosyntactic subcategorization frame, like the enclitic pronouns.

- (21) Ted's right. Ted is right.
 Ted's already left. Ted has already left.
 Ted'll help us. Ted will help us.

- (22)

is	's	am	'm	have	've	will	'll
has	's	are	're	had	'd	would	'd

5.1 CHARACTERISTICS

The substantial work on the clitic system of English done in the 1970's by Zwicky, Selkirk, Kaisse, and others already uncovered most of the characteristics of prosodic enclitics. They are subsyllabic in size (single consonants); there is a proper subset relation (wherever reduced auxiliaries can occur, corresponding full verbs can occur as well, but there are contexts where only the full form is possible.). This is allomorphy, not productive phonology: Enclitic auxiliaries are lexically listed allomorphs, not the results of general phonological reduction (Kaisse 1983, 94–95). For example, while *would*, *could*, and *should* all have reduced forms ([wəd, kəd, ʃəd]), only *would* has the idiosyncratic monoconsonantal form [d]: *I'd rather be home*. In terms of their position, enclitic auxiliaries are adjoined to the final syllable of the preceding word, just like the exponent of the plural/3sg/possessive morphemes (23).

- (23) is/has Matt'[s] gone, but Tom'[z] here, and Bruce'[əz] on his way.
 plural cat[s], home[z], busse[əz]
 3sg fit[s], come[z], misse[əz]
 poss Matt'[s], Tom'[z], Bruce'[əz] car

Enclitic forms correspond to auxiliaries, never to full verbs. Thus the word *has* occurs both as an auxiliary and as a main verb of possession, but the enclitic form 's (homophonous with that of *is*) functions only as an auxiliary. Thus in Anderson's (2008) example (24), the (b) version only has the bizarre reading in which Fred's sister is a cat.

- (24) a. Fred has adopted a new cat, and his sister Joanna has a cat, too.
 b. Fred's adopted a new cat, and his sister Joanna's a cat, too.

Enclitic auxiliaries are prosodic, not morphosyntactic, enclitics because there is no restriction on the host (i.e., it can attach to any preceding word irrespective of category), as shown by examples as in (25).

- (25)

has	The man you met's just arrived.
is	The man you met's making an awful fuss.

This indifference regarding the preceding context only holds for 's (*is, has*), not for the remainder (Zwicky 1970, 331; Kaisse 1983, 97–98), as shown in (26). We will henceforth restrict ourselves to these two.

- (26)

have	*?The people who cry've been there.
will	*?The people who cry'll be there.
are	*?The people you know're there.

The most important feature of enclitic auxiliaries is that they are prosodically deficient variants of full forms, consisting of a single consonant. A single consonant, especially an obstruent, cannot constitute a syllable in English, hence also cannot be a foot, or a prosodic word on its own. Disregarding their syntactic affiliation, they go with the word on their left, even if they are syntactically more closely related to the material on their right. The syntax-prosody mapping is given in (27). Note the mismatch of the syntactic and the prosodic parse of 's in (27).

- (27) S: [NP[Tim] TP['s leaving]]
 P: $((\varphi(\omega(\tau(\sigma(\text{Tim}'\mathbf{s})))))) (\varphi(\omega(\tau(\sigma(\text{lea})\sigma(\text{ving}))))))$

Our analysis appears in (28). The winning candidate (28a) parses the TP-initial 's with the subject and therefore fails to match both the subject NP and TP. It beats the more faithful candidate that preserves 's in φ -initial position by parsing it at the beginning of a prosodic word, violating standard positional faithfulness (28b). (To save space, we

will from now on suppress the outermost phrase corresponding to the whole sentence in all candidates).

(28)	NP[Tim]	TP[s leaving]	ω -Initial-Faith	Headedness	Match-Phrase	PWdCon
a. ▶	$\varphi(\omega\text{Tim's})$	$\varphi(\omega\text{leaving})$			* _{NP} * _{TP}	
b.	$\varphi(\omega\text{Tim})$	$\varphi(\omega\text{'sleaving})$	*			

A brief characterization of the constraints together with their ranking is given in (29).

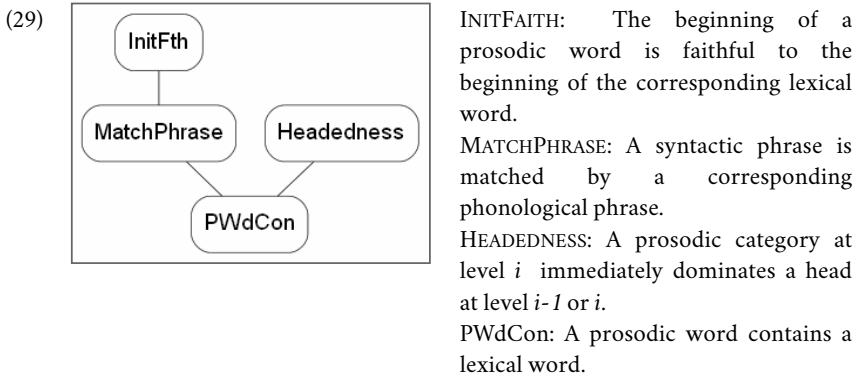

It is worth comparing the analysis of enclitic monoconsonantal 's, which cannot be parsed ω -initially, with that of proclitic reduced əs in (30), which receives a faithful φ -initial parse by the same constraint hierarchy.

(30)	NP[Tim]	TP[is leaving]	ω -Initial-Faith	Headedness	Match-Phrase	PWdCon
▶	$\varphi(\omega\text{Tim})$	$\varphi(\text{əs}\omega\text{leaving})$				
	$\varphi(\omega\text{Tim})$	$\varphi(\omega\text{is}\omega\text{leaving})$				* _W

5.2 FACTORIAL TYPOLOGY

Next we assess the predictions of the constraint system by studying the factorial typology of the system consisting of the representative inputs in (31) and the four constraints in (29), as produced in OTWorkplace (Prince, Tesar, and Merchant, <https://sites.google.com/site/otworkplace/>).

- (31) Inputs:
- [[Ray] [can]] / *I can eat more than ___*
 - [[Ray] [is]] / *I don't know where ___*
 - [[Tim] [is leaving]]
 - [[Tim] ['s leaving]]
 - [look [at ___]] / *What did Mary ___*

It contains the six languages in (32).

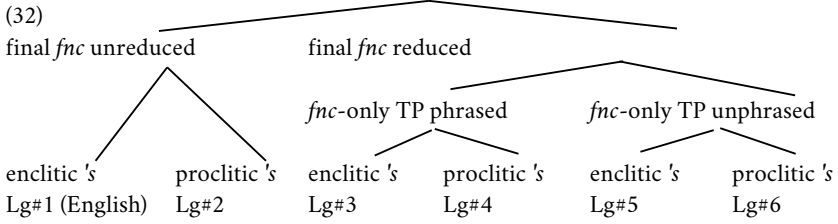

Lg#1

- $\varphi(\omega\text{Ray})\varphi(\omega\text{c}\grave{\text{a}}\text{n})$
- $\varphi(\omega\text{Ray})\varphi(\omega\text{i}s)$
- $\varphi(\omega\text{Tim})\varphi(\sigma\text{s}\omega\text{leaving})$
- $\varphi(\omega\text{Tim's})\omega\text{leaving}$
- $\varphi(\omega\text{look}\varphi(\omega\grave{\text{a}}\text{t}))$

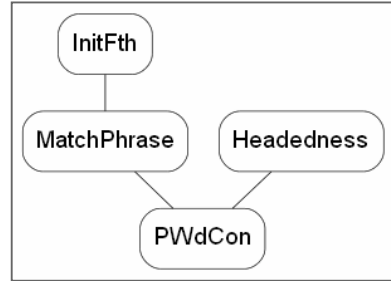

Lg#2

- $\varphi(\omega\text{Ray})\varphi(\omega\text{c}\grave{\text{a}}\text{n})$
- $\varphi(\omega\text{Ray})\varphi(\omega\text{i}s)$
- $\varphi(\omega\text{Tim})\varphi(\sigma\text{s}\omega\text{leaving})$
- $\varphi(\omega\text{Tim})\varphi(\omega\text{'sleaving})$
- $\varphi(\omega\text{look}\varphi(\omega\grave{\text{a}}\text{t}))$

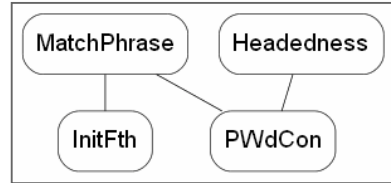

Lg#3

- $\varphi(\omega\text{Ray})\varphi(\sigma\text{c}\grave{\text{a}}\text{n})$
- $\varphi(\omega\text{Ray})\varphi(\sigma\text{s})$
- $\varphi(\omega\text{Tim})\varphi(\sigma\text{s}\omega\text{leaving})$
- $\varphi(\omega\text{Tim's})\varphi(\omega\text{leaving})$
- $\varphi(\omega\text{look}\varphi(\sigma\grave{\text{a}}\text{t}))$

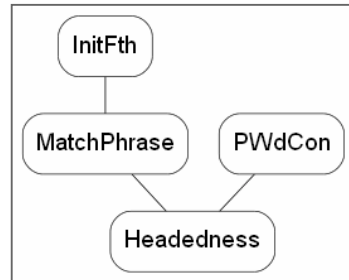

Lg#4

- a. $\varphi(\varphi(\omega\text{Ray})\varphi(\sigma\text{c}\alpha\text{n}))$
- b. $\varphi(\varphi(\omega\text{Ray})\varphi(\sigma\alpha\text{s}))$
- c. $\varphi(\varphi(\omega\text{Tim})\varphi(\sigma\alpha\text{s}\omega\text{leaving}))$
- d. $\varphi(\varphi(\omega\text{Tim})\varphi(\omega\text{'sleaving}))$
- e. $\varphi(\omega\text{look}\varphi(\sigma\alpha\text{t}))$

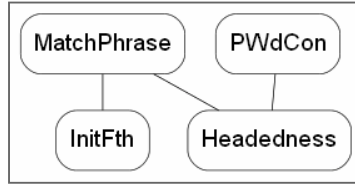

Lg#5

- a. $\varphi(\varphi(\omega\text{Ray})\sigma\text{c}\alpha\text{n})$
- b. $\varphi(\varphi(\omega\text{Ray})\sigma\alpha\text{s})$
- c. $\varphi(\varphi(\omega\text{Tim})\varphi(\sigma\alpha\text{s}\omega\text{leaving}))$
- d. $\varphi(\varphi(\omega\text{Tim}'\text{s})\varphi(\omega\text{'leaving}))$
- e. $\varphi(\omega\text{look}\sigma\alpha\text{t})$

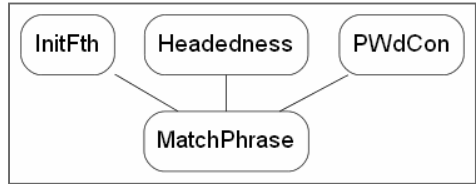

Lg#6

- a. $\varphi(\varphi(\omega\text{Ray})\sigma\text{c}\alpha\text{n})$
- b. $\varphi(\varphi(\omega\text{Ray})\sigma\alpha\text{s})$
- c. $\varphi(\varphi(\omega\text{Tim})\varphi(\sigma\alpha\text{s}\omega\text{leaving}))$
- d. $\varphi(\varphi(\omega\text{Tim})\varphi(\omega\text{'sleaving}))$
- e. $\varphi(\omega\text{look}\sigma\alpha\text{t})$

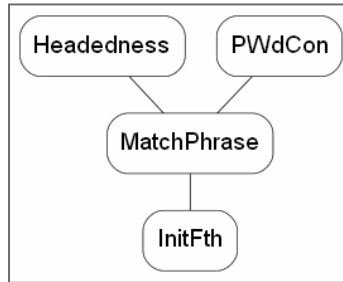

The first two languages leave phrase-final *fn*c unreduced. Lg#1 is English, and Lg#2 differs in showing a faithful phrase-initial parse of 's in (31d), violating word-initial positional faithfulness, which ranks below MATCH-PHRASE. Lg#3-Lg#6 all allow phrase-final *fn*c to reduce. This happens in two ways: In Lg#3 and Lg#4, *fn*c is its own phrase while being reduced, violating HEADEDNESS (MATCH-PHRASE, PWDCON >> HEADEDNESS). Monoconsonantal 's is either enclitic (Lg#3) or proclitic (Lg#4), depending on the relative ranking of INITFAITH and MATCH-PHRASE. Lg#5 and Lg#6 show reduced final *fn*c by leaving the *fn*c-only TP unphrased (HEADEDNESS, PWDCON >> MATCH-PHRASE). Again, monoconsonantal 's is either enclitic (Lg#5) or proclitic (Lg#6), depending on the ranking of INITFAITH and MATCH-PHRASE. This typology seems to reasonably reflect the crosslinguistic options. It can easily be expanded by including additional possibilities, such as allowing 's to delete, or to remain unsyllabified at the word level, which are of little interest to our current concerns.

5.3 NO PHRASE-FINAL ENCLISIS

We now have all necessary pieces in place to address our main question, the impossibility of phrase-final enclisis for monoconsonantal clitics. As a reminder, we give some examples of the phenomenon in (33) (after Anderson 2008).

- (33) a. Tim's happier than Kim is/*'s __. John is taller than Harry is/*'s __.
 b. Freddie's a werewolf this year for Halloween. Do you know what Tommy is/*'s __ (this year for Halloween)? Tommy has been a werewolf more often than Freddie has/*'s __ (on Halloween).
 c. John has known Mary longer than Fred has/*'s __ Martha.
 d. Who do you think you are/*'r __?
 e. Fred's an Independent: he'd no more campaign for a Democrat than he would/*'d __ for a Republican
 f. John is happier with their marriage than his wife is/*'s __.

Selkirk (1996, 198, footnote 5) observes that "[i]t is an interesting fact that these contracted forms are only possible if they are *not* phrase-final [...]. The atypical prosodic encliticization that they display must somehow reflect this fact. For now, this remains a puzzle." Anderson's (2008) observes that the TP's in (34a-c) are wellformed, but not the TP consisting just of the monoconsonantal (34d). This is in itself unremarkable since it holds for basic syllabic reasons.

- (34) a. [TP is happier] b. [TP's happier] c. [TP is __] d. *[TP's __]

The real question is why the simple phonological adjustment of reassigning the lone 's to the preceding phrase, as in (35), is also not a way out.

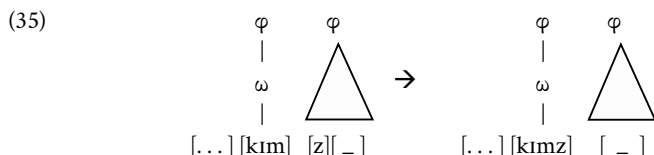

Taking up an idea first raised by Selkirk (1984, 366), Anderson's (2008, 11) insight is to interpret the impossibility of the move in (35) not as an idiosyncratic quirk of Modern English that could easily be changed, but rather as a reflection of a fundamental principle: The result of the phonological adjustment would be that the φ originally built over the phonetic material corresponding to the TP would now be left with no phonetic content at all. This is impossible. We state the ban on prosodic vacuity in a preliminary form in (36), and will later derive it from Match Theory.

- (36) *_φ∅: Phonetically empty PPhrases are disallowed.

The ban on prosodic vacuity has been argued by Kandybowicz (2015) to motivate a kind of *do*-support (*ye* 'do, make') in Asante Twi. Our question now is how to derive the ban on prosodic vacuity in our analysis. As things stand, the candidate with enclisis of 's is the winner in (37b) since MATCH-PHRASE is ranked too low to prevent this.

(37) a. Tim's leaving if		NP[Kim]	TP[is__]	Headed- ness	Match- Phrase	PWdCon
<i>correct</i> ▶		$\varphi(\text{Kim})$	$\varphi(\omega\text{is})$			*
		$\varphi(\text{Kim})$	$\varphi(\sigma\emptyset\text{s})$	*		
		$\varphi(\omega\text{Kim})$	ωis		* _{NP} * _{TP}	*
		$\varphi(\omega\text{Kim})$	$\sigma\emptyset\text{s}$		* _{NP} * _{TP}	
b. Tim's leaving if		NP[Kim]	TP['s__]	Headed- ness	Match- Phrase	PWdCon
<i>wrong</i> ▶!!!		$\varphi(\text{Kim}'\text{s})$	\emptyset		* _{NP} * _{TP}	
		$\varphi(\text{Kim})$	$\varphi('s)$	*		

We present two different ways of deriving the correct outcome here. The first one uses M-PARSE (Prince and Smolensky 1993) to select the null candidate instead of the wrong outcome. In the second approach, *is* and 's are competing allomorphs, and the first beats the second. As we will see, both require us to sharpen our understanding of MATCH constraints. A standard use of M-PARSE is as enforcer of the single-foot subcategorization (38a) on comparative adjectives in English (*pretty*, *prettier*; *red*, *redder*; but *beautiful*, **beautifuler*). As shown in (38b), the null candidate violating M-PARSE is preferable to a candidate violating the prosodic subcategorization constraint.

- (38) a. /-er/: morphological subcategorization: [A_]

 prosodic subcategorization: [Ft_]

b. /pretty-er/		A[Ft_]	M-Parse	/beautiful-er/		A[Ft_]	M-Parse
▶	$\Delta_{[Ft]}(\text{pretty-er})$			▶	$\Delta_{[Ft]}(\text{beauti}ful\text{-er})$	*	
	\emptyset		*		\emptyset		*

Where is M-PARSE ranked in the grammar? It cannot be too low in the ranking because then the null candidate would always win. A first attempt would be to rank it between MATCH-PHRASE and PWDCON, as in (39). This gets the right result when the desired candidate only violates a constraint ranked below M-PARSE, such as PWDCON in (39a), or is in fact the null candidate, as in (39b).

(39)			Headed-	Match-	M-Parse	PWdCon
a. Tim's leaving if	NP[Kim]	TP[is]	ness	Phrase		
<i>correct</i> ▶	$\varphi(\omega\text{Kim})$	$\varphi(\omega\text{is})$				*
	\emptyset				*	
	$\varphi(\omega\text{Kim})$	$\varphi(\sigma\partial\text{s})$	*			
	$\varphi(\omega\text{Kim})$	ωis		* _{NP} * _{TP}		*
	$\varphi(\omega\text{Kim})$	$\sigma\partial\text{s}$		* _{NP} * _{TP}		

b. Tim's leaving if			Headed-	Match-	M-Parse	PWdCon
	NP[Kim]	TP['s __]	ness	Phrase		
<i>correct</i> ▶		\emptyset			*	
	$\varphi(\omega\text{Kim}'\text{s})$			* _{NP} * _{TP}		*
	$\varphi(\omega\text{Kim})$	$\varphi('s)$	*			*

But it goes wrong in (40), where the desired winner in fact violates MATCH-PHRASE, which dominates M-PARSE.

(40)			Headed-	Match-	M-Parse	PWdCon
	NP[Kim]	TP['s leaving]	ness	Phrase		
<i>wrong winner!</i> ▶		\emptyset			*	
<i>desired winner:</i>	$\varphi(\omega\text{Kim}'\text{s})$	$\varphi(\omega\text{leaving})$		* _{NP} * _{TP}		*

Assembling the winner~loser pairs from(39) and (40) in a comparative tableau, we identify a ranking paradox (bolded) in (41).

(41)			Headed-	Match-	M-Parse	PWdCon
Winner	Loser		ness	Phrase		Con
a. \emptyset	$\sim \varphi(\omega\text{Kim}'\text{s})$			W	L	L
b. $\varphi(\omega\text{Kim}'\text{s})$	$\sim \emptyset$			L	W	L
c. $\varphi(\omega\text{Kim})$	$\varphi(\omega\text{is})$	$\sim \emptyset$			W	L

Ranking M-PARSE below MATCH-PHRASE gets the right result when we have a catastrophic MATCH-violation, akin to a MAX-violation: A failure to have any kind of phrase whatsoever corresponding to the TP $\text{TP}[s]$ in (41a). It gets the wrong result when the desired winner violates MATCH-PHRASE in a minor way, akin to an IDENT-violation, by reassigning 's to the subject's PPhrase in (41b). This suggests that we are in fact dealing with two different constraints. As a preliminary move, to be revised later, we add an "existential" MAX-type constraint MATCH- \exists -PHRASE to the constraint system which is distinct from general Match-Phrase and is only violated when a syntactic phrase has no prosodic correspondent whatsoever, of whatever category.

With M-PARSE sandwiched between the two types of Match-constraint, the correct distinctions are derived in (42), where the null-candidate wins in (a), but not in (b).

(42) Tim's leaving if		Init-Faith	Headed-ness	Match- \exists -Phrase	M-Parse	Match-Phrase	PWd Con
a.	$\text{NP[Kim]} \quad \text{TP['s ___]}$						
▶	\emptyset				*		
	$\varphi(\omega\text{Kim's})$			$*_{\text{TP}}$		$*_{\text{NP}^*\text{TP}}$	
	$\varphi(\omega\text{Kim}) \quad \varphi('s)$		*				
b.	Tim's leaving if	Init-Faith	Headed-ness	Match- \exists -Phrase	M-Parse	Match-Phrase	PWd Con
	$\text{NP[Kim]} \quad \text{TP['s leaving]}$						
▶	$\varphi(\omega\text{Kim's}) \quad \varphi(\omega\text{leaving})$					$*_{\text{NP}^*\text{TP}}$	
	\emptyset				*		
	$\varphi(\omega\text{Kim}) \quad \varphi(\omega\text{'sleaving})$	*					

The difference between existential MATCH- \exists -PHRASE and general MATCH-PHRASE is that the first just requires the existence of some prosodic correspondent or other, the second an exact match. This raises an interesting idea: As things stand, general MATCH-constraints create a serious redundancy within OT since the theory already contains a fully-worked-out subsystem that militates against all conceivable kinds of input-output discrepancies, namely, the system of alignment and faithfulness constraints. There is no need for MATCH-constraints to duplicate their work. A more radical, and more interesting, theory therefore suggests itself: (i) Replace the current conception of MATCH by a purely existential conception. (ii) Let familiar ALIGNMENT—together with the usual faithfulness constraints (IDENT, LINEARITY, UNIFORMITY, INTEGRITY, etc.) take care of the detailed measurement of correspondence.

5.4 WHY MATCH HAS TO BE AN EXISTENTIAL CONSTRAINT

We begin by defining existential MATCH- \exists as in (43).

(43) Let S be an input syntactic representation and P its corresponding output phonological representation.

MATCH- \exists (α, π): A constituent of type α with phonological content in S corresponds to some constituent of type π in P .

MATCH- \exists (π, α): A constituent of type π in P corresponds to some constituent of type α in S .

Exact correspondence (preservation of edges, no deletion, no insertion, uniqueness of mapping, order preservation, etc.) is enforced by S - P and P - S Alignment and Faithfulness. As originally defined by Selkirk (2011, 451), MATCH is not a new type of constraint, but simply two-sided ALIGNMENT. This alignment-based conception of

MATCH calls for gradient evaluation, but this has hardly ever been made use of in an essential way, to our knowledge. The intention has always gone beyond alignment, and has aimed for prosodic replication of the whole constituent, not just preservation of its edges (see Ishihara 2014). But checking on whole-scale correspondence requires the whole set of faithfulness constraints, and is in any case not easily, or profitably, expressed in a single constraint that can be evaluated gradiently. Elfner (2012, 28), in a move away from gradience, proposes an all-or-nothing categorical version of MATCH-PHRASE: "Suppose there is a syntactic phrase (XP) in the syntactic representation that exhaustively dominates a set of one or more terminal nodes α . Assign one violation mark if there is no phonological phrase (ϕ) in the phonological representation that exhaustively dominates all and only the phonological exponents of the terminal nodes in α ." As a categorical constraint, this is easy to evaluate, but it is unlikely to be workable in real life where standard phonology (such as the ONSET requirement) routinely leads to small deviations from perfect correspondence. We subsume Match Theory under General Correspondence Theory, which distinguishes purely existential MAX (requiring nothing but the existence of a correspondent in the output, which can be utterly different from the input element) from IDENT and other faithfulness constraints which deal with detailed aspects of correspondence (here, instantiated by AI-R(XP, ϕ)).²

	NP[Kim]	TP[s _]	Headed-ness	Match- \exists -Phrase	M- Parse	AI-R (XP, ϕ)	PWd Con
▶	\emptyset				*		
	ω Kim's)			* _{TP}		*	*
	ϕ (ω Kim)	ϕ ('s)	*				
b.	NP[Kim]	TP[s leaving]					
▶	ϕ (ω Kim's)	ϕ (ω leaving)				*	*
	\emptyset				*		

In the M-PARSE approach, /is/ and /'s/ are separate inputs that do not compete. *Kim is leaving* and *Kim's leaving* each win their competition—optionality as lexical choice. (*Tim's leaving if*) *Kim's* loses against the null candidate because the TP [*is* _] has become phonologically vacuous. (*Tim is leaving if*) *Kim is* wins its competition. In an alternative allomorphy approach, /is/ and /'s/ compete with each other as different allomorphs of the same input morpheme. All allomorphs enter the same competition. Priority (Mascaró 1996) (or some economy constraint) prefers /'s/ to /is/. Standard alignment-based MATCH continues to have the familiar problem: *Ceteris paribus*,

² Things are different in the two-stage view of prosodic structure formation developed in Selkirk (2017), which distinguishes Spell-Out-by-MATCH from the phonology, which incorporates prosodic structure faithfulness constraints, in a division of labor reminiscent of the proposal made here.

unranked MATCH-PHRASE (preferring *is*) and PRIORITY (preferring *'s*) admit both outputs as winning candidates in 45) (optionality as lack of ranking). But there continues to be a problem with phrase-final *'s* (46).

(45) a. I wonder if		Match-Phrase	Priority: 's > is	PWd Con
$\text{NP}[\text{Kim}]$	$\text{TP}[\text{is/'s leaving}]$			
► $\varphi(\omega\text{Kim})$	$\varphi(\sigma\sigma\omega\text{leaving})$		*	
	$\varphi(\omega\text{Kim})$		*	*
	$\varphi(\omega\text{Kim}'s)$	$^*_{\text{NP}}$		

b. I wonder if		Priority: 's > is	Match-Phrase	PWd Con
$\text{NP}[\text{Kim}]$	$\text{TP}[\text{is/'s leaving}]$			
$\varphi(\omega\text{Kim})$	$\varphi(\sigma\sigma\omega\text{leaving})$	*		
$\varphi(\omega\text{Kim})$	$\varphi(\omega\text{is}\omega\text{leaving})$	*		*
► $\varphi(\omega\text{Kim}'s)$	$\varphi(\omega\text{leaving})$		$^*_{\text{NP}}$	$^*_{\text{TP}}$

(46) a. Tim's leaving.		Match-Phrase	Priority: 's > is	PWd Con
I wonder if	$\text{NP}[\text{Kim}]$ $\text{TP}[\text{is/'s } _]$			
<i>correct</i> ► $\varphi(\omega\text{Kim})$	$\varphi(\omega\text{is})$		*	*
	$\varphi(\omega\text{Kim}'s)$	$^*_{\text{NP}}$	$^*_{\text{TP}}$	

b. Tim's leaving.		Priority: 's > is	Match-Phrase	PWd Con
I wonder if	$\text{NP}[\text{Kim}]$ $\text{TP}[\text{is/'s } _]$			
	$\varphi(\omega\text{Kim})$ $\varphi(\omega\text{is})$	*		*
<i>wrong</i> ► !!!	$\varphi(\omega\text{Kim}'s)$		$^*_{\text{NP}}$	$^*_{\text{TP}}$

Again, high-ranked MATCH- \exists -PHRASE together with ALIGN-R correctly predicts the sole winning candidate.

(47) Tim's leaving		Match- \exists -Phrase	Align-R (XP, φ)	Priority: 's > is	PWd Con
a. if	$\text{NP}[\text{Kim}]$ $\text{TP}[\text{is/'s } _]$				
► $\varphi(\omega\text{Kim})$	$\varphi(\omega\text{is})$			*	*
	$\varphi(\omega\text{Kim}'s)$	$^*_{\text{TP}}$	$^*_{\text{NP}}$		

Tim's leaving		Match- \exists -Phrase	Priority: 's > is	Align-R (XP, φ)	PWd Con
b. if	$\text{NP}[\text{Kim}]$ $\text{TP}[\text{is/'s } _]$				
► $\varphi(\omega\text{Kim})$	$\varphi(\omega\text{is})$		*		*
	$\varphi(\omega\text{Kim}'s)$	$^*_{\text{TP}}$		$^*_{\text{NP}}$	

Sentences without gaps do not incur MATCH- \exists violations, so the allomorph variation arises as before.

(48)		TP[is/'s leaving]	Match- \exists - Phrase	Align-R (XP, φ)	Priority: 's > is	PWd Con
a.	I wonder if	NP[Kim]				
	▶ $\varphi(\omega\text{Kim})$	$\varphi(\sigma\partial\text{s}$ $\omega\text{leaving})$			*	
		$\varphi(\omega\text{Kim})$			*	*
		$\varphi(\omega\text{Kim}'\text{s})$		* _{NP}		
b.	I wonder if	NP[Kim]	Match- \exists - Phrase	Align-R 's > is	Priority :	PWd Con
		$\varphi(\omega\text{Kim})$		*		
		$\varphi(\omega\text{Kim})$		*		*
	▶ $\varphi(\omega\text{Kim}'\text{s})$	$\varphi(\omega\text{leaving})$			* _{NP}	

Both analyses (M-PARSE and Allomorph PRIORITY) need the existential version of MATCH-PHRASE instead of the alignment-based version. Which, if any, of these two approaches—M-PARSE or allomorphy—is the correct one? It is hard to think of decisive evidence either way. Kaisse (1983, 95) makes the interesting observation that the contexts where 's is admitted are not literally a proper subset of those where is is admitted. There are exceptions to this subset relation in examples such as *There's/*is/*has} a new book been written*. She notes that this is suggestive of morphemes with separate listings in the lexicon. Since true allomorphs have one lexical entry, one could interpret this to favor the M-PARSE approach, where the two have separate lexical entries.

6 CONCLUSION

By insisting that syntactic constituents must in some form be matched in prosody, Match Theory provides very simple explanations (i) for positions where weak elements must appear in their strong form—because otherwise a phonological phrase would have no head—, and (ii) for positions where a functional element cannot undergo enclisis—because if it did, a whole syntactic constituent would go unmatched. In order for this explanation to go through, Match constraints must have a purely existential force, and merely insist on the existence of a prosodic correspondent to a syntactic phrase. Detailed correspondence falls to standard alignment/faithfulness constraints.

REFERENCES

- Anderson, Stephen. 2008. English reduced auxiliaries really are simple clitics. *Lingue e Linguaggio* vii: 1–18.
- Bennett, Ryan, Emily Elfner, and James McCloskey. 2016. Lightest to the right: An apparently anomalous displacement in Irish. *Linguistic Inquiry* 47: 169–234.
- Booij, Geert. 1996. Cliticization as prosodic integration: The case of Dutch. *The Linguistic Review* 13: 219–242.
- Cardinaletti, Anna, and Michal Starke. 1999. The typology of structural deficiency: a case study of the three classes of pronouns. In *Clitics in the Languages of Europe*, ed. Henk van Riemsdijk, 145–233. Berlin: Mouton de Gruyter.
- Chomsky, Noam. 2007. Approaching UG from below. In *Interfaces + Recursion = Language? Chomsky's Minimalism and the View from Syntax-Semantics*, ed. Uli Sauerland and Hans-Martin Gärtner, 1–30. Berlin: Mouton de Gruyter.
- Chomsky, Noam. 2008. On phases. In *Foundational Issues in Linguistic Theory. Essays in Honor of Jean-Roger Vergnaud*, ed. Robert Freidin, Carlos P. Otero, and Maria Luisa Zubizarreta, 291–321. Cambridge, MA: MIT Press.
- Chomsky, Noam. 2013. Problems of projection. *Lingua* 130: 33–49.
- Elfner, Emily. 2012. Syntax-Prosody Interactions in Irish. Doctoral dissertation, University of Massachusetts, Amherst.
- Elordieta, Gorka. 2007. Minimum size constraints on intermediate phrases. In *Proceedings of the 16th International Congress of Phonetic Sciences*, ed. Jürgen Trouvain and J. Barry William, 1021–1024.
- Elordieta, Gorka. 2015. Recursive phonological phrasing in Basque. *Phonology* 32: 49–78.
- Haider, Hubert. 1986. V-Second in German. In *Verb Second Phenomena in Germanic Languages*, ed. Hubert Haider and Martin Prinzhorn, 49–75. Dordrecht: Foris.
- Hall, T. Alan. 1999. Phonotactics and the prosodic structure of German function words. In *Studies on the Phonological Word*, ed. T. Alan Hall and Ursula Kleinhenz, 99–131. Amsterdam, The Netherlands, and Philadelphia, USA: John Benjamins.
- Harizanov, Boris. 2014. The role of prosody in the linearization of clitics: evidence from Bulgarian and Macedonian. In *Formal Approaches to Slavic Linguistics 22: The McMaster Meeting 2013*, ed. Cassandra Chapman, Olena Kit, and Ivona Kucerova, 109–130. Ann Arbor, MI: Michigan Slavic Publications.
- Ishihara, Shinichiro. 2014. Match Theory and the recursivity problem. In *Proceedings of FAJL 7: Formal Approaches to Japanese Linguistics*, ed. Shigeto Kawahara and Mika Igarashi, 69–88. Cambridge, MA: MIT Working Papers in Linguistics. 73.
- Ito, Junko, and Armin Mester. 1992. *Weak layering and word binarity*. Linguistic Research Center Report LRC-92-09. University of California, Santa Cruz.

- [Appeared in Honma, Takeru, Masao Okazaki, Toshiyuki Tabata and Shin-ichi Tanaka, eds. 2003. *A New Century of Phonology and Phonological Theory*. Tokyo: Kaitakusha. 26-65.].
- Ito, Junko, and Armin Mester. 2007. Prosodic adjunction in Japanese compounds. In *Formal Approaches to Japanese Linguistics: Proceedings of FAJL 4*, ed. Yoichi Miyamoto and Masao Ochi, 97–111. MIT Working Papers in Linguistics 55. Cambridge, Massachusetts: MIT Department of Linguistics and Philosophy.
- Ito, Junko, and Armin Mester. 2009. The extended prosodic word. In *Phonological Domains: Universals and Deviations*, ed. Janet Grijzenhout and Barış Kabak, 135–194. Berlin: Mouton de Gruyter.
- Ito, Junko, and Armin Mester. 2013. Prosodic subcategories in Japanese. *Lingua* 124: 20–40.
- Kaisse, Ellen. 1983. The syntax of auxiliary reduction in English. *Language* 59: 93–122.
- Kandybowicz, Jason. 2015. On prosodic vacuity and verbal resumption in Asante Twi. *Linguistic Inquiry* 46: 243–272.
- Kisseberth, Charles W. 1994. On domains. In *Perspectives in Phonology*, ed. Jennifer Cole and Charles W. Kisseberth, 133–166. Stanford, CA: CSLI.
- Mascaró, Joan. 1996. External allomorphy as emergence of the unmarked. In *Current Trends in Phonology: Models and Methods*, ed. Jacques Durand and Bernard Laks, 473–483. University of Salford, Manchester: European Studies Research Institute.
- McCarthy, John J. 1993. A case of surface constraint violation. *Canadian Journal of Linguistics* 38: 127–153.
- McCarthy, John J., and Alan S. Prince. 1993. Generalized Alignment. In *Yearbook of Morphology*, ed. Geert Booij and Jaap van Marle, 79–153.
- Myrberg, Sara. 2010. The intonational phonology of Stockholm Swedish. Doctoral dissertation, Department of Scandinavian Languages, Stockholm University.
- Myrberg, Sara. 2013. Sisterhood in prosodic branching. *Phonology* 30: 73–124.
- Ostrove, Jason. 2016. The prosody of agreement in San Martín Peras Mixtec. Qualifying paper. UC Santa Cruz.
- Peperkamp, Sharon. 1997. *Prosodic Words*. The Hague: Holland Academic Graphics.
- Prince, Alan S. 1983. Relating to the grid. *Linguistic Inquiry* 14: 19–100.
- Prince, Alan S., and Paul Smolensky. 1993. *Optimality Theory: Constraint Interaction in Generative Grammar*. Brunswick, New Jersey, and Boulder, Colorado: Rutgers University and University of Colorado, Boulder.
- Ross, John Robert. 1982. Pronoun deleting processes in German, presented at the Annual Meeting of the LSA, San Diego, California.
- Selkirk, Elisabeth. 1972. The Phrase Phonology of English and French. Doctoral dissertation, MIT.
- Selkirk, Elisabeth. 1984. *Phonology and Syntax: The Relation between Sound and Structure*. Cambridge, MA: MIT Press.

- Selkirk, Elisabeth. 1996. The prosodic structure of function words. In *Signal to Syntax*, ed. James L. Morgan and Katherine Demuth, 187–213. Mahwah, NJ: Lawrence Erlbaum.
- Selkirk, Elisabeth. 2011. The syntax-phonology interface. In *The Handbook of Phonological Theory. 2nd edition*, ed. John Goldsmith, Jason Riggle, and Alan Yu, 435–485. Oxford: Blackwell Publishing.
- Selkirk, Elisabeth. 2017. Syntactic Constituency Spell-Out though Match Constraints Talk presented at SPOT Workshop, UC Santa Cruz, Nov. 18, 2017.
- Selkirk, Elisabeth, and Seunghun J. Lee. 2015. Constituency in sentence phonology: an introduction. *Phonology* 32: 1–18.
- Spaelti, Philip. 1994. Weak edges and final geminates in Swiss German. In *Proceedings of NELS 24*, ed. Mercè González, 573–588. Amherst, MA: GLSA.
- Vigário, Marina. 1999. On the prosodic status of stressless function words in European Portuguese. In *Studies on the Phonological Word*, ed. T. Alan Hall and Ursula Kleinhenz, 255–294. Amsterdam Studies in the Theory and History of Linguistic Science. Amsterdam and Philadelphia: John Benjamins.
- Wackernagel, Jacob. 1892. Über ein Gesetz der indogermanischen Wortstellung. *Indogermanische Forschungen* 1: 333–436.
- Weir, Andrew. 2012. Left-edge deletion in English and subject omission in diaries. *English Language and Linguistics*: 105–129.
- Werle, Adam. 2009. Word, phrase, and clitic prosody in Bosnian, Serbian, and Croatian. Doctoral dissertation, Amherst, MA: University of Massachusetts, Amherst.
- Zwicky, Arnold M. 1970. Auxiliary reduction in English. *Linguistic Inquiry* 1: 323–336.

Passivization of German Double-Object Constructions: Theory and Usage*

Vera Lee-Schoenfeld
University of Georgia

1 O TANNENBAUM, O TANNENBAUM, DEIN KLEID WILL MICH WAS LEHREN

These words, the beginning of the third verse of the popular German Christmas song 'Oh Christmas Tree', are an instance of the German double-accusative construction. In fact, they are the first example that came to my mind when asked about this construction. Unlike the vast majority of German double-object verbs, *lehren* 'teach' takes two accusative-marked objects:

- (1) Dein Kleid will mich was lehren.
your.NOM dress wants me.ACC something.ACC teach
'Your dress (look) wants to teach me something.'

The typical double-object construction in German consists of a ditransitive verb taking a dative-marked indirect object and an accusative-marked direct object in that order, as in (2).

- (2) Jemand hat ihm den Seiltrick erklärt.
someone.NOM has him.DAT the.ACC rope.trick explained
'Someone explained the rope trick to him.'

Using the canonical passive auxiliary *werden* 'be', the only passivization possibility here is for the direct object to become the subject and therefore be realized with nominative rather than accusative case. The indirect object keeps its dative case.

- (3) Der Seiltrick wurde ihm erklärt.
the.NOM rope.trick was.PASS him.DAT explained
'The rope trick was explained to him.'

*Thank you, Jim, for always emphasizing the importance of usage data in our theory-focused graduate program! Your careful empirical work leading to landmark theoretical insights has been a great inspiration.

Interestingly, the passivization possibilities involving a minimally different example with the double-accusative verb *lehren* are much less straightforward (see e.g. Czepluch 1988, Lang 2007, Duden 2006, 2016, and Lee-Schoenfeld and Diewald 2017). The active version of the sentence is given in (4) and the passivization options are shown in (5) and (6).¹

- (4) Jemand hat ihn den Seiltrick gelehrt. [active]
someone.NOM has him.ACC the.ACC rope.trick taught
 ‘Someone taught him the rope trick.’
- (5) a. ?Er wurde den Seiltrick gelehrt. [werden-passive]
he.NOM was.PASS the.ACC rope.trick taught
- b. ??Der Seiltrick wurde ihn gelehrt. [werden-passive]
the.NOM rope.trick was.PASS him.ACC taught
- c. Ihm wurde der Seiltrick gelehrt. [werden-passive]
him.DAT was.PASS the.NOM rope.trick taught
 ‘He was taught the rope trick.’
- (6) Er kriegte den Seiltrick gelehrt. [kriegen-passive]
he.NOM got the.ACC rope.trick taught
 ‘He got taught the rope trick.’

Canonical *werden*-passivization via nominative-marking of neither the first object (*ihn*) nor the second object (*den Seiltrick*) leads to a completely well-formed utterance (see (5)a-b). Only if the first object is a dative instead of accusative object (*ihm* instead of *ihn*), can passivization target the second object by marking it with nominative case and result in a readily acceptable utterance (see (5)c). As expected in a verb-second language, either nominal can occupy the first position (or be topicalized), as long as the finite verb is in second-position. In (5c), the dative nominal has been topicalized. The best solution, at least colloquially, seems to be to passivize the first object but to use *bekommen* or *kriegen* (‘get’) instead of the canonical passive auxiliary *werden* (see (6)). This so-called *bekommen/kriegen*-passivization normally turns a dative object into the nominative-marked subject (see e.g. Haider 1984, Reis 1985, Wegener 1985b, and, for a more recent discussion and analysis, Alexiadou et al. 2013).

In English, on the other hand, the double-accusative pattern represented by the German example in (4) is the normal ditransitive pattern (see (7)) and comes with straightforward passivization possibilities (see (8a-b)) (see e.g. Woolford 1993).²

- (7) Someone taught him the rope trick. [active]

¹The judgments in (5) are based on my intuitions and informal consultations with other native speakers.

²Example (8b) is only acceptable for certain speakers if the indirect object pronoun *him* is phonologically reduced.

- (8) a. He was taught the rope trick. [be-passive]
 b. *The rope trick was taught him.

It is well-established that, in English, only the first accusative object, whose case feature is valued with structural accusative case by agentive ν (in line with Burzio 1986), can become the subject under passivization. The second object can be argued to be lexically case-licensed by V (see Anagnostopoulou 2003 and Twiner 2016 for an overview of the relevant literature).

While it is obviously the single accusative object that becomes the subject when the verb is mono-transitive in German as well, the 2016 Duden Grammatik says, “Bei Verben mit doppeltem Akkusativ wird das personale Objekt zum Subjekt” (Duden 2016: 944) (‘In the case of double-accusative verbs, it is the animate object that becomes the subject’), but this source marks examples of both type (5a) and type (5b) with a “?”. It is the 2006 Duden Grammatik (Duden 2006: 952) that indeed marks example type (5b), with the subject derived from the inanimate object, with a “*”, i.e. as unacceptable. Likewise, Czepluch (1988: 281) judges an example of type (5a), with the animate object as subject, better than one of type (5b), with the inanimate object as subject:

- (9) a. ? dann ist der Junge das Lied gelehrt worden. [werden-pass]
 then has the.NOM boy the.ACC song taught been.PASS
 b. * dann ist den Jungen das Lied gelehrt worden. [werden-pass]
 then has the.ACC boy the.NOM song taught been.PASS
 ‘Then the boy was taught the song.’

Importantly, both (5c) and (6), the passivization options that are the most readily acceptable, rely on the animate object of the double-accusative verb being dative instead of accusative-marked. In other words, these options appear to be repair strategies that rely on fitting the exceptional double-accusative construction into the normal ditransitive pattern of a dative indirect object followed by the accusative direct object, as shown in (2).³ Given the semantics of this pattern, the normally accusative-marked animate object seems to be interpreted not as a Patient but as the Recipient in a scene of transfer (see Lang 2007 and Lee-Schoenfeld and Diewald 2017). It is the goal of this paper to both capture these observations formally and investigate them further empirically.

The remainder of the paper is structured as follows. Section 2 provides a formal account of German double-object as well as bene/malefactive (applicative) constructions and their passivization. Section 3 presents empirical support for the proposed formal account by examining corpus data. More specifically, section 3.1 takes a brief look at previous corpus-based work on German double-accusative verbs, and section 3.2 presents the results of a very recent corpus search by Lee-Schoenfeld and Diewald (2017) on the diachronic development

³In fact, the meaning ‘teach’ is also expressed by the very commonly used verb *beibringen*, which follows the normal ditransitive pattern of DAT > ACC. Thus, speakers may use DAT > ACC instead of ACC > ACC with the exceptional verb *lehren* in analogy with the more regular verb *beibringen*.

Position (iii) is sister-to-V when position (iv) is not needed. It hosts the direct object of simple transitive and prototypical ditransitive verbs like *lieben* ‘love’ and *geben* ‘give’.

- (13) a. Sie hat ihn geliebt.
she has him.ACC loved
 ‘She loved him.’
- b. Sie hat ihm einen Kuss gegeben.
she has him a.ACC kiss given
 ‘She gave him a kiss.’

The direct object, of course, becomes the subject under passivization. This is shown in (14).

- (14) a. Er wurde geliebt.
he.NOM was.PASS loved
 ‘He was loved.’
- b. Ein Kuss wurde ihm gegeben.
a.NOM kiss was.PASS him given
 ‘A kiss was given to him.’

Position (iv), sister-to-V, is the lexical (idiosyncratic) ACC case or clausal complement position, licensed by V, and it hosts the second object of a double-accusative verb. Example (4) is given here again as (15) with an added clausal complement option (*Seil zu springen* ‘to jump rope’) shown as extraposed, following the verb.

- (15) Jemand hat ihn den Seiltrick gelehrt / Seil zu springen.
someone has him the.ACC rope.trick taught / rope to jump
 ‘Someone taught him the rope trick / to jump rope.’

The analysis in (10) predicts that the second object does not passivize, which is obviously correct when it comes to clausal complements and also in line with the judgments in the Duden Grammatik (2006, 2016) and by Czepluch (1988). This is illustrated in (16).

- (16) *Der Seiltrick / Seil zu springen wurde ihn gelehrt.
the.NOM rope.trick / rope to jump was.PASS him taught
 intended: ‘The rope trick was taught to him. / He was taught to jump rope.’

Position (iv) also hosts the inanimate DAT(ive) object of exceptionally patterning verbs like *aussetzen* ‘expose’, an example of which is given in (17). The DAT case of this kind of object is lexical or idiosyncratic, licensed by V itself. As will become clear in a moment, the proposed analysis makes a crucial distinction between lexical idiosyncratic case on the one hand and inherent predictable case on the other.

- (17) Man hat ihn der Kälte ausgesetzt.
one has him.ACC the.DAT cold exposed
 ‘People exposed him to the cold.’

As expected, the structural ACC-object becomes the subject under passivization, while the idiosyncratic DAT-object does not change. As shown in (18), passivization with *kriegen* is impossible.

- (18) Er wurde der Kälte ausgesetzt / *Die Kälte kriegte ihn ausgesetzt.
he was.PASS the.DAT cold exposed / the.NOM cold got him exposed
 ‘He was exposed to the cold.’

Position (ii), Spec affectee *vP*, is the inherent or predictable DAT case position, licensed by affectee *v*, and it hosts the first object of a double-accusative verb when this is reinterpreted as the indirect object, the Recipient, of a prototypical ditransitive construction. Example (19a) shows the double-accusative verb *lehren* ‘teach’ following the DAT > ACC pattern, and (19b) shows the prototypical ditransitive verb *erklären* ‘explain’, which always follows this pattern.

- (19) a. Jemand hat ihm den Seiltrick gelehrt.
someone has him.DAT the.ACC rope.trick taught
 ‘Someone taught him the rope trick.’
 b. Jemand hat ihm den Seiltrick erklärt.
someone has him.DAT the.ACC rope.trick explained
 ‘Someone explained the rope-trick to him.’

As we know from (6), which is repeated here as (20a), the inherent DAT-object becomes the subject under *kriegen* (‘get’)-passivization.

- (20) a. Er kriegte den Seiltrick gelehrt.
he.NOM got the.ACC rope.trick taught
 ‘He got taught the rope trick.’
 b. Er kriegte den Seiltrick erklärt.
he.NOM got the.ACC rope.trick explained
 ‘He got the rope trick explained to him.’

Position (ii) also hosts the argument of mono-transitive verbs selecting a DAT-object, like *helfen* ‘help’, *gratulieren* ‘congratulate’, and *widersprechen* ‘contradict’. An example of *helfen* is given in (21). The DAT case here is again licensed by affectee little *v*, which, in this scenario, assigns not a Recipient but a Beneficiary role.

- (21) Man hat ihm geholfen.
one has him.DAT helped
 ‘People helped him.’

As shown in (22), for some speakers, the inherent DAT-object of a verb like *helfen* can become the subject under *kriegen*-passivization (see also Beermann 2011).

- (22) Er kriegte geholfen.
he.NOM got helped
 'He was getting helped.'

I take this to indicate that the DAT case here is not idiosyncratic lexical but inherent case. It is predictably assigned to animate arguments and regularly alternates with NOM case for those speakers who allow (22). In this sense, it is similar to structural ACC case. However, in line with Grewendorf 2002 and Haider 2010, I do not take the DAT-NOM alternation in examples like this to be evidence for DAT being structural case because, unlike the ACC-NOM alternation in canonical passivization constructions, DAT-NOM alternation depends on the case-changing nominal playing a certain type of semantic role. It is always some kind of Affectee, that is, a necessarily animate Goal, Recipient, or Bene/Maleficiary (see also Bader & Häussler 2013).

Position (ii) can also host a necessarily animate external possessor, a so-called “free dative” that is compatible with verbs selecting a (potentially possessed) internal argument and an optional Affectee argument, like *ruinieren* ‘ruin’ in (23). Here, DAT case is licensed by the Bene/Maleficiary role assigning version of affectee little *v* (see Lee-Schoenfeld 2006, 2016).

- (23) Man hat ihm den Garten ruiniert.
one has him.DAT the.ACC garden ruined
 ‘People ruined his garden.’

As predicted and shown in (24), this inherent DAT case alternates with NOM case under *kriegen*-passivization.

- (24) Er kriegte den Garten ruiniert.
he.NOM got the.ACC garden ruined
 ‘He got his garden ruined.’

Finally, position (i), Spec agentive *vP*, is the external argument (proto-agent) position which hosts the subject of any (di)transitive or unergative verb. NOM case is licensed at a distance by finite T (tense/agreement). An example with an unergative verb is given in (25).

- (25) ... dass tatsächlich ein Junge im Chor mitsingt.
that indeed a.NOM boy in.the chorus with.sings
 ‘... that there is indeed a boy singing in the chorus.’

Position (i) is null when the verb is passivized or unaccusative. A passivization of the unergative verb *mitsingen* ‘sing (along)’ is shown in (26).

- (26) ... dass \emptyset im Chor mitgesungen wird.
that \emptyset in.the chorus with.sung is.PASS
 ‘... that there is singing (along) in the choir.’

To sum up, the analysis just presented, as diagrammed in (10), correctly predicts the (un)grammaticality of the double-accusative facts (active and passive) known from the literature (see (4)-(6) and (9) of section 1) and it works for regular (di)transitive and “free dative” (applicative) constructions. Additionally, the proposed account captures well-known co-occurrence restrictions on DAT-objects (see e.g. Maling 2001 and Bosse 2015). Generally, there can only be one DAT-object at a time. The incompatibility of the two DAT-objects in (27), for example, falls out from the analysis because the affected animate arguments, Beneficiary and Recipient, compete for the same DAT-case-licensing position, namely (ii) in (10). The same holds for the combination of an optional possessor DAT and the obligator DAT argument of verbs like *helfen* ‘help’ in (28).⁵

(27) * Reich der Oma dem Opa bitte das Salz!
pass the.DAT grandma the.DAT grandpa please the.ACC salt
 ‘Pass Grandpa the salt for Grandma, please!’⁶

(28) * Ich helfe dem Papa dem Kollegen.
I help the.DAT dad the.DAT colleague
 ‘I’m helping dad’s colleague.’

Overall, the analysis proposed in (10) is in line with much of the existing literature on double-object constructions, but there are also some important departures from previous work that I briefly address here. In line with Woolford 2006 and partly in line with Haider 2010 but contra Anagnostopoulou 2003, the proposed analysis makes a crucial distinction between two types of non-structural cases, namely idiosyncratic lexical case on the one hand and (regular) predictable inherent case on the other. Also, as mentioned above, I agree with Grewendorf 2002 and Haider 2010 that the *kriegen* (‘get’)-passive is not evidence for DAT being structural case, but, contra Haider, I take it to be evidence for this kind of DAT being inherent rather than lexical case and for analyzing DAT-object-selecting verbs like *helfen* ‘help’ as inherent case licensors (via affectee *v*) rather than lexical case-licensors. Note that, following Chomsky 1986, I assume that inherent case is assigned to a DP by the same head that introduces this DP as its argument and thus assigns it a theta-role (in this case, by the affectee *v* to the DP in its specifier). On the other hand, given Burzio’s (1986) Generalization, I take structural accusative case to be assigned by the external-argument-introducing, agentive *v* down to any DP in the verbal domain that still needs case (in this case, to the DP in Spec VP or in the sister-to-V slot, depending on whether the V itself has lexical case to assign or not).

⁵Notice that, according to the proposal in (10), an animate position-(ii) dative should be grammatical when co-occurring with an inanimate position-(iv) dative since these datives do not compete for the same slot. This prediction seems to be borne out given that examples like *Man hat dem.dat armen Mann das Kind der.dat Kälte ausgesetzt* ‘One exposed the poor man’s child to the cold’ are considerably less degraded than examples (27)-(28). My thanks to Jason Merchant for asking about this.

⁶Ethical datives, like *mir* ‘me’ in *Reich mir.DAT der.DAT Oma doch bitte das Salz!* (‘Please pass grandma the salt, will you?’) are the exception here. They are, however, best analyzed not as verbal arguments but as discourse markers (see Diewald 2016 for a recent overview of dative usages in German).

In line with Bruening 2010 and Bosse 2015, I argue, contra Pylkkänen 2008, that the base configuration of arguments is DAT > ACC, with each object being generated in its own verbal projection, namely in affectee ν P (or ApplP) and VP, respectively. But contra Bruening and Bosse, the account in (10) requires no raising of arguments into a higher verbal projection in order to establish Pylkkänen (2008)’s “low applicative” transfer of possession relation. I assume that the lexical VP and affectee ν P can be considered one extended domain after V-to- ν raising.

Furthermore, in line with Grewendorf 2002 and contra both Müller 1995 and Anagnostopoulou 2003, the DAT-case licensing position in the configuration in (10) is above the ACC-case licensing position, so that we have the commonly assumed I(indirect) O(bject) > D(irect) O(bject) base configuration. This means that, unlike in Müller 1995, there is no need to posit A'-movement of the IO to a DAT-case licensing position. Spec affectee ν P is a normal A-position. I tentatively propose that the complication of the IO not being able to bind a DO anaphor, as shown in (29), can be captured by Grewendorf’s (2002: 63) account, where the DO anaphor is generated in a projection above the IO-containing verbal layer.

- (29) . . . dass der Arzt_i dem Patient_n_j sich_i/_{*j} im Spiegel zeigte.
that the doctor the.DAT patient self in.the mirror showed
 ‘. . . that the doctor_i showed the patient_j himself_i/_{*j} in the mirror.’

Grewendorf’s approach is supported by the fact that, unlike a DO that is a full DP, the anaphor *sich* ‘self’ can occur to the left of the IO and even to the left of the subject, as is shown in (30).

- (30) a. . . . dass der Arzt_i sich_i/_{*j} dem Patient_n_j im Spiegel zeigte.
 b. . . . dass sich_i/_{*j} der Arzt_i dem Patient_n_j im Spiegel zeigte.

For now, a detailed extension of the analysis to these binding facts needs to be relegated to future research. The focus of the remainder of this paper is on the actual usage of double-accusative verbs like *lehren* ‘teach’ and thus on providing empirical support for the proposed constellation in (10), abstracting away from anaphoric objects.

3 A CORPUS-BASED EXAMINATION OF THE DOUBLE-ACCUSATIVE CONSTRUCTION

As briefly mentioned in section 1, double-accusative verbs are rare, and the double-accusative construction, while certainly familiar to native speakers, exhibits an exceptional double-object pattern, with both objects being accusative-marked instead of just the second one, yielding ACC > ACC rather than the typical DAT > ACC pattern. When it comes to the passivization of the double-accusative construction, acceptability judgments become murky. The passivization of neither

object sounds completely grammatical, but the first, animate object becoming the subject seems to be a bit better than the second, inanimate object doing so, at least according to the Duden Grammatik (2006, 2016) and Czepluch (1988). There also seems to be a preference for realizing the first object with dative rather than accusative case. This section aims to establish that these intuitions and claims indeed correspond to the actual usage of double-accusative verbs. Subsection 3.1 summarizes corpus-based work by Lang (2007) on the active use of *lehren* ‘teach’, and subsection 3.2 presents the results of Lee-Schoenfeld & Diewald’s (2017) diachronic corpus study focusing on the use of *lehren* in both active and passive constructions.

3.1 PREVIOUS WORK ON DOUBLE-ACCUSATIVE VERBS: ACC > ACC VS. DAT > ACC

The only other double-accusative verbs in German besides *lehren* (‘teach’) are *kosten* (‘cost’), *abfragen* (‘test/quiz’), *abhören* (‘test/quiz’), and *fragen* (‘ask’). In a 2007 seminar paper, Lang reports that there is a strong tendency to mark the first object with DAT rather than ACC and that the differentiation of object-types is based on both semantics and syntax (Wegener 1985a, 1986, Plank 1987, Braun 1993, Duden 1995, Wahrig 2003). If the first object is ACC-marked, then it is very much Theme/Patient-like, that is, maximally distinct from the subject in animacy. If the first object is DAT-marked, on the other hand, it is an animate Recipient. But if there is only one object, it must be ACC-marked, even if it is interpreted as animate Recipient. This is shown in (31), where *lehren* is used mono-transitively.

- (31) ... dass der Pfarrer die Kinder / *den Kindern lehrt.
 that the pastor the.ACC children / the.DAT children teaches
 ‘... that the pastor teaches the children.’

The passivization facts are reported to be unclear. When DAT replaces ACC, DAT tends to be used in sentence-initial position, and when there is no DAT-marking, NOM tends to be used in sentence-initial position. The prescriptive recommendation is to simply avoid the passive with double-accusative verbs.

The results of Lang’s (2007) corpus search, for which he used newspaper corpora from the Institute of German Language (IDS) Mannheim and focused on the active use of *lehren*, yielded a total of 3678 tokens. Only about a quarter of all occurrences had two realized objects: 12% with the pattern of ACC > ACC, 6% with the pattern of DAT > ACC, and another 6% with the pattern of undifferentiated ACC/DAT (as in *uns* ‘us’) > ACC. About half of all occurrences had only one object, which was either a whole clause (propositional), an undifferentiated ACC/DAT-marked one, or an inanimate ACC-marked one. An example of the latter is given in (32).

- (32) ... dass das Spiel einen leichtfertigen Umgang mit Geld lehrt.
 that the game a.ACC careless handling with money teaches
 ‘... that the game teaches a careless handling of money.’

Approximately another quarter had no object at all, as in (33).

- (33) . . . dass die Professorin an der Humboldt Universität lehrt.
that the professor.FEM at the Humboldt University teaches
' . . . that the professor teaches at the Humboldt University.'

Lang concludes that, if *lehren* occurs with two objects, it is relatively frequently used with a DAT-marked object (DAT > ACC), not only colloquially.

3.2 THE DEVELOPMENT FROM ACC > ACC TO DAT > ACC AND WHAT REALLY HAPPENS IN THE PASSIVE

From the literature cited by Lang (2007) as well as his own investigation, Lee-Schoenfeld and Diewald (henceforth “we”, 2017) conclude that the first object of double-accusative verbs corresponds to the necessarily animate indirect object of the prototypical ditransitive pattern. This means that the original animate Patient/Theme is interpreted as Recipient, a variant of the INDIRECTUS (a sympathy-invoking co-participant, see Lehmann et al. 2004), and that, depending on its semantic features, the second object of double-accusative verbs can be interpreted as a typical inanimate Theme/Patient. More specifically, we hypothesize that the second ACC-marked object was originally not a typical inanimate Patient but an adverbial ACC (“accusative of measure” in the case of *kosten* ‘cost’) or an “inner object” and can often be interpreted as a more Patient-like object. This causes the prototypical ditransitive schema (a scene of transfer) with a Recipient DAT to become available.

We searched the DWDS core corpus (<http://www.dwds.de/ressourcen/kernkorpus/>), which consists of different types of text (fiction and poetry, newspaper articles, science writing, functional writing) and contains about 100,000,000 words. Unlike Lang, we targeted not only the active use of *lehren* ‘teach’ but also its passive use and chose two different time spans for our searches in order to be able to comment on possible diachronic developments. The following two subsections, reporting on the passive and the active search results, respectively, each begin with a table summarizing our findings and continue with discussion and representative examples.

3.2.1 SEARCH 1: PASSIVE USE OF LEHREN

Time Span	1900-1909	1990-1999
Σ Passive uses (accessible tokens)	39 (138)	29 (44)
DAT animate: <i>wird den Kindern gelehrt</i>	5	1
DAT/ACC animate: <i>wird uns gelehrt</i>	2	0
ACC animate: <i>wird die Kinder gelehrt</i>	3	0
ACC inanimate/propositional: <i>wird den Seiltrick gelehrt / wird gelehrt, dass . . . / wird gelehrt zu . . .</i>	1	1
Subject, referential or propositional (inanimate)	36 (34)	28 (27)
Zero-Subject, expletive <i>es</i>	3	1
Passive AUX <i>werden</i>	39	28
Passive AUX <i>kriegen</i>	0	1

Table 1: Passive in first (1900-1909) and second (1990-1999) time span

What this table shows is that passive *lehren* is rarely used with both a passivized and an unpassivized object. If it does have an unpassivized object in addition to the passivized one (28% in first time span and only 7% in second time span), then we found that, most commonly, the subject is inanimate, while the unpassivized object is animate and marked with undifferentiated ACC/DAT-case (as in 34a) or with DAT (as in 34b); ACC-marked objects do occur, but only three times in the first time-span.⁷

- (34) a. *Wir leiden unter der eigenen Winzigkeit, unter den engen Grenzen unseres Wissens und Lebens, seitdem uns die Endlosigkeit von Raum und Zeit gelehrt wird.*
 since us.ACC/DAT the endlessness of space and time taught is.PASS
animate obj. inanimate subj.
 ‘We suffer from our own tininess, from the narrow limits of our knowledge and life, ever since the endlessness of space and time was taught to us.’
 (31.12.1903/ Belletristik/ Heyking, Elisabeth von: Briefe, die ihn nicht erreichten. In: Deutsche Literatur von Frauen, Berlin: Directmedia Publ. 2001 [1903], S.32339)
- b. *Diesen drei jungen Männern ist nie christliche Nächstenliebe gelehrt worden, . . .*
 these.DAT three young men has never Christian brotherly.love taught been.PASS
animate obj. inanimate subj.
 ‘These three young men have never been taught Christian brotherly love.’
 (31.12.1994/Belletristik/Jentzsch, Kerstin: Seit die Götter ratlos sind, München: Heyne 1999 [1994], S.153)

There were only two examples with an animate subject and an inanimate object: one in the first time span where the inanimate object was a propositional infinitive complement (35a), and one in the second time span formed with *kriegen* (35b). The latter serves as clear evidence of ACC-marking of animate objects being replaced by DAT-marking because, as noted in section 1, the *kriegen*-passive targets DAT-objects.

⁷In all our corpus examples, we only give glosses for the clause containing the relevant object(s) and/or subject, but we often include more of the sentence in order to provide speakers of German with as much context as possible.

- (35) a. *Von Haus aus waren die germanischen Pferde klein und unansehnlich; sie werden auch nicht gelehrt," sagt Tacitus (Germ. 6),*
 they are.PASS also not taught says Tacitus
animate subj.
"verschiedenartige Wendungen nach unserer Art zu machen; . . .
 various turns according.to our.GEN way to make
inanimate obj. (clausal)
 'By nature, the Germanic horses were small and unattractive; "they were also not taught," says Tacitus, "to perform different kinds of turns following our technique."
 (31.12.1908/ Wissenschaft/ Fischer, Hermann: Grundzüge der Deutschen Altertumskunde, Leipzig: Quelle & Meyer 1917 [1908], S. 101)
- b. *Nee, aber wie stehst du dazu, zu dem,*
was du gelehrt kriegst . . .
 what you taught get.PASS
inanimate obj. animate subj.
 'No, but what's your opinion of what you're getting taught?'
 (31.12.1991/ Belletristik/ Brussig, Thomas: Wasserfarben, Berlin: Aufbau-Taschenbuch-Verl. 2001 [1991], S. 179)

Our preliminary conclusions regarding the passivization facts concerning the double-accusative verb *lehren* are as follows. When passivized, *lehren* is used more and more like a simple transitive verb, with the inanimate Theme/Patient ACC-object becoming the subject and no other object being realized (as in *Hier wird Mathematik gelehrt* 'Here, mathematics is taught'). As expected, passivization of the full double-accusative argument structure of *lehren*, with one object becoming the subject and the other keeping its ACC-marking, is hardly found at all anymore. In order to shed light on the 'why' and 'how' of this development, we took a step back and revisited the active use of *lehren*.

3.2.2 SEARCH 2: ACTIVE USE OF LEHREN

Time Span	1900-1909	1990-1999
Σ of active uses investigated	180	180
Intransitive	22	62
Transitive	91	66
Ditransitive	67	52
DAT animate	1	3
DAT/ACC animate (instances of <i>uns</i>)	28 (26)	19 (18)
ACC animate	43	35
ACC inanimate	153	106
Subject animate	67	116
Subject inanimate	113	64

Table 2: Active uses in first (1900-1909) and second (1990-1999) time span

This table shows a strong increase of the intransitive use of *lehren*.⁸ We identified

⁸In the first time span (1900-1909), there were 611 active verbs among 674 accessible tokens (706 total), and in the second time span (1990-1999), there were 180 active verbs among 223 accessible tokens (283 total). In order to facilitate direct comparison, we reduced the number of tokens from the first time span to 180, so that it matched the number of tokens from the second time span.

two different intransitive meanings: (i) ‘show/illustrate/exemplify’ with an inanimate subject (as in 36a), which occurred more frequently in the first time span, and (ii) ‘be instructor (at a certain school/institution)’ with an animate subject (as in 36b), which occurred more frequently in the second time span. We take this to be an indication of a lexical split. A new intransitive verb with meaning (ii) has been added to the existing (di)transitive verb *lehren* (‘teach somebody something’). It seems that meaning (i) is on its way out.

- (36) a. *Aus diesen beiden Mineralen setzt sich auch, wie eingehende Untersuchungen gelehrt haben, die Grundmasse selbst zusammen.*
 as thorough investigations taught have
inanimate subj.
 ‘As thorough investigations have shown, it is out of these two minerals that the matrix itself is composed.’
 (31.12.1900/ Gebrauchsliteratur/ Jahrbuch des Vereins für wissenschaftliche Pädagogik, 1900, Bd. 32)
- b. *Er lehrt am Institut d’études européennes an der Universität Paris VIII.*
he teaches at.the Institut d’études européennes at the University Paris VIII
animate subj.
 ‘He teaches at the Institute of European Studies at the University Paris VIII.’
 (12.09.1997/ Zeitung/ Die Zeit, 12.09.1997, Nr. 38)

As noted in subsection 3.1, the mono-transitive use of *lehren* is only possible with an ACC (or undifferentiated ACC/DAT)-object. We identified two variants of meaning (ii), ‘be instructor of something (inanimate object)’ (as in 37a) and ‘be instructor of somebody (animate object)’ (as in 37b). The transitive variant of meaning (i) ‘show/illustrate/exemplify’ (with a propositional object, as in 37c) still occurred frequently in the first time span, but much less so in the second one.

- (37) a. *Was aber hat man dann eigentlich gelehrt?*
what but has one.NOM then actually taught
inanimate obj.
 ‘But what did people actually teach then?’
 (31.12.1900/ Gebrauchsliteratur/ Jahrbuch des Vereins für wissenschaftliche Pädagogik, 1900, Bd. 32)
- b. *Wer andere lehren beziehungsweise bilden will, muß zuvor studieren . . .*
 who.NOM others teach or.else educate wants must beforehand study
animate obj.
 ‘Someone who wants to teach or educate others, has to study first.’
 (28.02.1997/ Zeitung/ Die Zeit, 28.02.1997, Nr. 10)
- c. *Ein Blick in die Vergangenheit lehrt,*
 a look into the past shows
daß . . . in der Verwaltung das Gelehrtentum vorherrschte.
that in the administration the learned.class predominated
clausal obj.
 ‘A look at the past shows that, in the administration, the educated class was in power.’
 (31.12.1901/ Gebrauchsliteratur/ Baudissin, Wolf von u. Baudissin, Eva von: Spemanns goldenes Buch der Sitte. In: Zillig, Werner (Hg.), Gutes Benehmen, Berlin: Directmedia Publ. 2004 [1901], S. 3310)

As for the ditransitive use of *lehren*, in the first time span, we found consistent ACC-marking of the animate object, but the inanimate object was often propositional (‘someone/something.NOM makes someone.ACC learn that something holds’). We call this the **causative construction** of *lehren* (see also Luraghi & Zanchi To

appear), which is indeed ditransitive but often shows up without actual double-accusative-marking because a clause, of course, cannot be case-marked. An example is given in (38a). In the second time span, we found slightly more DAT-marked animate objects, but also more inanimate non-propositional ACC-objects ('someone.NOM gives someone.ACC/DAT something.ACC to learn'). We call this the **scene of transfer construction** of *lehren*, which employs the DAT case to avoid double-accusative-marking, as shown in (38b). Also noteworthy is the frequent use of undifferentiated ACC/DAT-marking on animate objects (e.g. *uns* 'us') in both time spans, which, again, results in no actual double-accusative-marking, as exemplified in (38c-d).

- (38) a. *Man hatte sie nie gelehrt, daß es noch etwas Höheres als sie gab.*
 one had her.ACC never taught that it still something higher than her existed
animate ACC-obj. clausal obj.
 'Nobody had ever taught her that there was something superior to her.'
 (31.12.1902/ Belletristik/ Janitschek, Maria: Die neue Eva. In: Deutsche Literatur von Frauen, Berlin: Directmedia Publ. 2001 [1902], S. 36059)
- b. *Um 1645 lehrte ein Chinese den Töpfern . . . die Bereitung besserer Schmelzfarben . . .*
 around 1645 taught a Chinese-man
the.DAT ceramists the.ACC preparation of.better enamel.colors
animate DAT-obj. inanimate ACC-obj.
 'Around 1645, a Chinese man taught the ceramists the preparation of better enamel colors.'
 (31.12.1993/ Wissenschaft/ o. A.: Lexikon der Kunst - P. In: Olbrich, Harald (Hg.), Lexikon der Kunst, Berlin: Directmedia Publ. 2001 [1993], S. 26460)
- c. *Das hat uns nicht erst*
that.ACC has us.ACC/DAT not just
inanimate ACC-obj. animate ACC/DAT-obj.
der Prozess gegen Stellbogen gelehrt . . .
 the lawsuit against Stellbogen taught
 'Not just the lawsuit against Stellbogen taught us this.'
 (05.04.1900/ Zeitung/ Die Fackel [Elektronische Ressource], 2002 [1900])
- d. *Was lehrt uns das?*
what.ACC teaches us.ACC/DAT that
inanimate ACC-obj. animate ACC/DAT-obj.
 'What did that teach us?'
 (30.09.1999/ Zeitung/ Die Zeit, 30.09.1999, Nr. 40)

So, why and how is the double-accusative pattern (ACC > ACC) becoming the prototypical ditransitive pattern (DAT > ACC)? With the older ditransitive use of *lehren* frequently involving a propositional inanimate object, ACC-marking of the animate object did not typically lead to ACC > ACC and did not resemble a typical scene of transfer. Use of DAT instead of ACC for the animate object only became necessary or intuitive (in analogy with the prototypical ditransitive DAT > ACC verbs in German) when it became more common to use non-propositional (PROP) inanimate objects. Furthermore, the re-interpretation of the formerly causative (NOM > ACC > PROP) construction as a scene of transfer (NOM > DAT > ACC) construction seems to be taking place via the critical context of the animate object having a case-undifferentiated ACC/DAT form, most frequently *uns* ('us').

3.2.3 CONCLUSIONS REGARDING THE PASSIVIZATION OF LEHREN

To summarize our search results, if an unpassivized object occurs at all, it is more commonly DAT than ACC-marked. Due to three unexpected instances of passivization from the first time span of our search, where the second object became the subject and the first object kept its ACC case, we found the subject of passivized ditransitive *lehren* to be slightly more commonly derived from the underlying inanimate object (as in ‘something was taught him’) than from the animate object (as in ‘he was taught something’). However, what speaks for the passivization pattern of ‘he was taught something’ over ‘something was taught him’ and thus for the Duden judgment in (5a) and (5b), as well as Czepluch’s (1988) judgments in (9a-b) is that the inanimate object frequently used to be propositional and would therefore have resisted promotion to subject status. The best solution to passivizing ditransitive *lehren* is the *kriegen* (‘get’)-passive, which targets DAT-objects and goes with the increasing use of DAT-marking on the animate object of double-accusative verbs. We found only one such passivization in the second time span (35b). A search of a spoken language corpus, though, would likely yield many more instances of the *kriegen*-passive.

4 WAS DIESER AUFSATZ UNS LEHREN WILL ‘WHAT THIS PAPER WANTS TO TEACH US’

Clearly, a bigger written language corpus search and probably also a spoken corpus search are needed to find clear-cut support for all parts of the formal analysis presented in section 2, especially for the prediction that only the first object of a double-accusative construction can passivize. However, the small diachronic search reported on here does offer indirect support for this prediction by pointing out that the second object frequently used to be propositional. It also manages to shed light on the growing tendency of the first object to be dative rather than accusative-marked by suggesting that what mainly used to be a causative construction turned into a scene-of-transfer construction. The proposed formal analysis captures all acceptable passivization possibilities of double-accusative constructions I have seen in reference works and the literature (the exception being those three instances of passivization from the early 1900’s of my collaborator’s and my own corpus search), and it also captures double-object constructions, featuring a variety of dative argument types, more broadly. It does so while maintaining Burzio’s (1985) Generalization and without the need for unmotivated movements. The key to the analysis is the structural distinction between two types of “non-structural” case, predictable inherent case on the one hand and idiosyncratic lexical case on the other. Whether the core of the analysis can be maintained once instances of the direct object being the anaphor *sich* ‘self’ are considered, is a question for future research. Corpus-based studies of the other four double-accusative verbs, *kosten* (‘cost’), *abfragen* (‘test/quiz’), *abhören* (‘test/quiz’), and *fragen* (‘ask’), and an investigation of how the proposed analysis

handles the results of these studies are planned as a part of this future research as well.

REFERENCES

- Alexiadou, Artemis, Anagnostopoulou, Elena, and Christina Sevdali. 2013. Dative-nominative alternations in Germanic languages: A generative perspective. *Lingue e Linguaggi* 9: 7-20.
- Anagnostopoulou, Elena. 2003. *The syntax of ditransitives: Evidence from clitics*. Berlin: Mouton de Gruyter.
- Bader, Markus and Jana Häussler. 2013. How much *bekommen* is there in the German *bekommen* passive? In Artemis Alexiadou and Florian Schäfer (eds.), *Non-canonical passives*. 115-139. Amsterdam: John Benjamins.
- Beermann, Dorothee. 2001. Verb semantics and ditransitivity. In Marc van Oostendorp and Elena Anagnostopoulou (eds.), *Progress in Grammar: Articles at the 20th Anniversary of the Comparison of Grammatical Models Group in Tilburg*. Dutch Royal Academy Publishing.
- Bosse, Solveig Jana. 2015. *Applicative Arguments: A Syntactic and Semantic Investigation of German and English*. New York: Peter Lang Inc., International Academic Publishers.
- Braun, Peter. 1993. *Tendenzen in der deutschen Gegenwartssprache. Sprachvarietäten*. 3rd Edition. Urban-Taschenbücher, Volume 297. Stuttgart/Berlin/Köln: Kohlhammer.
- Bruening, Benjamin. 2010. Ditransitive asymmetries and a theory of idiom formation. *Linguistic Inquiry* 41: 519-562.
- Burzio, Luigi. 1986. *Italian Syntax: A Government-Binding Approach*. Dordrecht: Reidel.
- Chomsky, Noam. 1986. *Knowledge of Language*. New York: Praeger.
- Czepluch, Hartmut. 1988. Kasusmorphologie und Kasusrelationen. *Linguistische Berichte* 116: 275-310.
- Diewald, Gabriele. 2016. Non-central usages of datives. In Gabriele Diewald (ed.), *Special Issue: Non-central Usages of Datives*. Language Typology and Universals 69. 1-14. Berlin/Boston: De Gruyter.
- Duden. 1995. Drosdowski, Günther (ed.) *Grammatik der deutschen Gegenwartssprache*, Volume 4. 5th edition. Mannheim: Dudenverlag.
- Duden. 2006. *Die Grammatik*. Der Duden in zwölf Bänden, Volume 4. 7th edition. Mannheim: Bibliographisches Institut.
- Duden. 2016. *Die Grammatik*. Der Duden in zwölf Bänden, Volume 4. 9th edition. Mannheim: Bibliographisches Institut.
- Grewendorf, Günther. 2002. *Minimalistische Syntax*. Tübingen & Basel: Francke/UTB.
- Haider, Hubert. 1984. Mona Lisa lächelt stumm – Über das sogenannte deutsche 'Rezipientenpassiv'. *Linguistische Berichte* 89: 32-42.
- Haider, Hubert. 2010. *The Syntax of German*. Cambridge University Press.

- Lang, Peter. 2007. Grammatik und Norm: Direktes Objekt, indirektes Objekt und der doppelte Akkusativ. Ms. Universität Zürich.
- Lee-Schoenfeld, Vera. 2006. German Possessor Datives: Raised *and* Affected. *Journal of Comparative Germanic Linguistics* 9: 101–142.
- Lee-Schoenfeld, Vera. 2016. The syntax of external and internal possessor variation in German inalienable possession constructions. In Gabriele Diewald (ed.), *Special Issue: Non-central Usages of Datives*. Language Typology and Universals 69. 113–129. Berlin/Boston: De Gruyter.
- Lee-Schoenfeld, Vera and Gabriele Diewald. 2017. Passivization possibilities in double-accusative constructions. *Proceedings of the Linguistic Society of America* 2, 9:1–14. <http://dx.doi.org/10.3765/plsa.v2i0.4050>.
- Lehmann, Christian, Yong-Min Shin and Elisabeth Verhoeven. 2004. *Direkte und indirekte Partizipation. Zur Typologie der sprachlichen Repräsentation konzeptueller Relationen* (2nd edition). ASSIDUE, Arbeitspapiere des Seminars für Sprachwissenschaft der Universität Erfurt Nr. 13.
- Luraghi, Silvia and Chiara Zanchi. To appear. Double accusative constructions and ditransitives in Ancient Greek. *Folia Linguistica* – Special issue on ditransitives.
- Maling, Joan. 2001. Dative: The heterogeneity of the mapping among morphological case, grammatical functions, and thematic roles. *Lingua* 111(4): 419–464.
- Müller, Gereon. 1995. *A-bar Syntax. A Study of Movement Types*. Studies in Generative Grammar 42. Berlin: Mouton de Gruyter
- Plank, Franz. 1987. Direkte indirekte Objekte, oder: Was uns lehren lehrt. *Leuvense Bijdragen* 76: 37–61.
- Pylkkänen, Liina. 2008. *Introducing arguments*. Cambridge, MA: MIT Press.
- Reis, Marga. 1985. Mona Lisa kriegt zuviel. *Linguistische Berichte* 96: 140–155.
- Twiner, Nicholas. 2016. Southern coreferential applicatives. Ms. University of Georgia. (Presented at BLS 42.)
- Wahrig. 2003. Dittmann, Jürgen, Thieroff, Rolf, and Adolphs, Ulrich (ed.) *Fehlerfreies und gutes Deutsch*. Gütersloh/München: Wissen Media Verlag.
- Wegener, Haide. 1985a. *Der Dativ im heutigen Deutsch*. Tübingen: Narr.
- Wegener, Haide. 1985b. Er bekommt widersprochen. Argumente für die Existenz eines Dativpassivs im Deutschen. *Linguistische Berichte* 96: 127–139.
- Woolford, Ellen. 1993. Symmetric and asymmetric passives. *Natural Language & Linguistic Theory* 11(4): 679–728.
- Woolford, Ellen. 2006. Lexical case, inherent case, and argument structure. *Linguistic Inquiry*, 37(1): 111–130.

We say “How high?”: Adverbs, negation, and verb movement in a verb-final language^{*}

Emily Manetta
University of Vermont

1 THE PUZZLE

Verb-stranding verb phrase ellipsis (VVPE) refers to a phenomenon in which an entire verb phrase is elided under identity with a verb phrase in an antecedent clause, but the verb itself is stranded outside the ellipsis site. VVPE has been discovered and analyzed in detail in a wide variety of unrelated languages, including Irish (McCloskey 1991), Hebrew (Doron 1991, Goldberg 2005), Portuguese (Martins 1994), Russian (Gribanova 2013a, b), and Greek (Merchant, this volume). I provide a naturally occurring example from Hindi-Urdu (Manetta, to appear):

- (1) KK: Kabhi kisi-ko dil di-ya?
Ever someone-ACC heart give-PFV.M
‘Have you ever given your heart to someone?’

Audience: Di-ya!
Give-PFV.M
‘(I) have given (my heart to someone)!’

KK: MaiN-ne bhi di-ya!
1SG-ERG also give-PFV.M
‘I have also given (my heart to someone)!’

[“Om Shanti Om” by Anand Bakshi, performed by Kishore Kumar in *Karz* (1980)]

For those languages in which it has been investigated, identifying clear instances of VVPE is challenging when there are other syntactic processes at work that

^{*}It is likely that nearly all of the insights of consequence that underlie the small bit of work done in this paper have their origin in a talk, class discussion, or paper authored by Jim McCloskey. For the opportunity to honor Jim, and for their thoughtful comments, I thank the editors of this volume. I am also grateful to Rajesh Bhatt, Alice Davison, Ayesha Kidwai, and Ghanshyam Sharma for their contributions, at various points, to the data appearing here. Thanks to Line Mikkelsen, Vera Gribanova, and audiences at INALCO, Paris 2016 for useful conversations and exchanges. Above all, my deepest gratitude and warmest wishes to Jim McCloskey, to whom I am indebted for a number of fudgies at the Stevenson Coffee Shop, and for my career.

can cause internal arguments or other VP-internal material to go missing. For instance, Hindi-Urdu permits null arguments (e.g. Butt and King 1997). Further, Simpson, Choudhury, and Menon (2013) claim that Hindi-Urdu has a narrower ellipsis operation targeting arguments, argument ellipsis.

- (2) Main-ne (us-ko) dekh-aa.
Ist-ERG 3rd-ERG see-PFV.M
 ‘I saw it.’
- (3) a. Amit apni premika-ko pyaar kar-ta hai
Amit self's.F girlfriend-ACC love do-PRES.3MSG AUX
 ‘Amit_i loves his_j girlfriend.’
 b. Ravi bhi pyaar karta hai.
Ravi also love do-PRES.3MSG AUX
 ‘Ravi_k also loves (his_k girlfriend).’
 (Simpson, Choudhury, and Menon 2013:6)

The task then becomes to establish diagnostics which distinguish VVPE from these other processes producing similar strings.

One such diagnostic is the so-called “adverb test”: a two-clause sequence in which the antecedent clause contains a VP-adjoined adverb and that adverb may be interpreted as present in the VP-ellipsis site in the elliptical clause (this test has a relatively long history – e.g. Matos 1992; Oku 1998; Doron 1991; Goldberg 2005; Simpson, Chowdhury, and Menon 2013). The reasoning is as follows: if internal arguments can only go missing due to the presence of a null pronominal or argument ellipsis, the adverbial reading should be completely absent for the second clause. If, on the other hand, the adverbial reading is available, the material must have gone missing as a result of VVPE. For Hindi-Urdu, Simpson, Chowdhury, and Menon show that temporal adverbials and VP-adverbs modifying manner can be elided and are optionally interpretable in the site of ellipsis, as in (4b) below. They also show that if the adverb is elided and interpreted in the ellipsis site, any VP-internal arguments must go missing as well. That is, (4c) indicates that there is no process permitting adjuncts within the VP to go missing independently without arguments doing the same (even though the reverse is certainly possible). (4b) must then represent a case of true VVPE.

- (4) a. Ram-ne Chomsky-ka naya lekh do baar paRh-a.
Ram-ERG Chomsky-GEN new writing two time read-PST.MSG
 ‘Ram read the new paper by Chomsky twice.’
 b. Raj-ne bhi paRh-a.
Raj-ERG also read-PST.MSG
 ‘Raj also read (the paper twice).’
 c. Raj-ne bhi vo lekh paRh-a.
Raj-ERG also that writing read-PST.MSG
 ‘Raj also read the paper.’ NOT communicated: ‘twice’ (SCM 2013: 112)

However, a puzzle emerges in the implementation of the adverb test in a number of languages in antecedent-correlate pairs in which the correlate clause includes negation. Consider (5b), in which the downward entailing environment means that the situations described by the reading which includes the adverb are not a subset of the situations described when the adverbial is excluded. If the adverb reading were available in (5b), it would represent a very strong argument in favor of VVPE. However, many speakers find that the reading of (5b) that includes the adverb, what we will call the null adjunct reading, is inaccessible.

- (5) a. Ram-ne Chomsky-ka naya lekh dhyaan-se paRh-a.
Ram-ERG Chomsky-GEN new writing carefully read-PRF.MSG
 ‘Ram read the new paper by Chomsky carefully.’
- b. Raj-ne nahiiN paRh-a.
Raj-ERG NEG read-PRF.MSG
 ‘Raj did not read (the new paper by Chomsky (?* carefully)).’

The sentence in (5a) asserts that Ram read the paper with care, but it seems that (5b) has a dominant reading in which Raj did not read the paper at all (carefully or otherwise). If the null adjunct reading were indeed completely unavailable in these environments, it would cast doubt on whether VVPE exists in the language at all, since the operation should hypothetically be possible for any verb phrase, regardless of its content or context.

The mystery deepens when we consider two additional factors. First, this apparent failure of the adverb test has been reported for a number of languages such as Persian and Russian, which have been argued to have VVPE and for which other diagnostics suggest VVPE is at work. Second, there is a remarkable amount of variability in the judgements reported for the equivalent of (5b) in these languages, even among native speaker linguists. For instance, for Persian, Rasekhi (2014) claims that the null adjunct reading is not available in downward entailing environments, though a footnote (fnnt 7) admits that some speakers can obtain these readings with very strong contrastive stress on the equivalent of the adverb “carefully”. On the other hand, Toosarvandani (to appear) states the null adverb interpretation is indeed available in these environments in Persian without any further discussion (Toosarvandani to appear, p. 18). Turning to Russian, Vera Gribanova (p.c.) observes that the null adjunct reading is relatively difficult to obtain in the Russian equivalent of (5b), though Russian has been argued quite convincingly to feature VVPE (Gribanova 2013a, b; 2017). In Japanese, Oku 1998 claims that the null adjunct reading is not present at all (though this claim is hedged in a footnote), while Funakoshi (2016) disagrees, claiming that it is indeed the preferred reading in certain scenarios.

Here, I investigate the apparent failure of the adverb test in Hindi-Urdu as in (5b) and provide evidence that the null adjunct reading can be facilitated by additional context and by adjusting the structure of the antecedent (following methods developed in Funakoshi (2016) for Japanese). The fact that the null adjunct reading can be made more palatable supports the potential for VVPE in a

given language, but we are still left with a serious question: if VVPE is readily available, why would it be so difficult to get the null adjunct reading to begin with?

In this paper, I advance a preliminary analysis of the interaction of contrastive clauses and ellipsis that explains the inaccessibility of the null adjunct reading for many speakers in the equivalent of (5b). The analysis draws on insights found in a rich program of research on the nature of head movement and in particular recent work investigating the interaction of syntactic processes of verb movement and ellipsis (Hartman 2011; LaCara 2016; McCloskey 2016; Gribanova and Harizanov 2016; Gribanova 2017; Sailor, forthcoming; i Gribanova and Mikkelsen, this volume). Locating the position of the verb in the syntax is made all the more challenging in head-final languages like Hindi-Urdu, since verb movement to higher functional heads would typically be string-vacuous. The account I propose for the apparent failure of the adverb test in (5b) hinges on the height of the verbal complex in the syntactic structure. If, in this kind of negated response, the verbal complex has moved quite high, outside of TP, then the ellipsis of vP will be blocked by a constraint like MaxElide (Merchant 2001, 2008; Takahashi and Fox 2005), which in effect forces ellipsis of the largest possible constituent. Of course, TP ellipsis would be possible, but that would presumably create a string distinct from (5b), with the subject missing. Importantly, the analysis I propose below also provides a formal way to understand the variability in judgments for the equivalent of (5b) that is evidenced crosslinguistically, and the fact that the null adjunct reading can emerge more clearly under certain circumstances.

Overall, the work done in this paper is part of a larger effort to better understand head movement in head-final languages, in which the evidence for syntactic verb movement can be relatively subtle (Manetta, to appear). Ellipsis provides an important window into how high the inflected verb must move to escape verb phrase ellipsis. The specific contribution in the present paper is a clear account for a crosslinguistic puzzle dogging analyses of VVPE grounded in current work on head movement, polarity, and wider conditions on ellipsis.

2 FACILITATING THE NULL ADJUNCT READING

Although native speakers tend to report that the null adjunct reading is hard to obtain in (5b), if additional rich context is provided or the structure of the antecedent sentence is altered, the null adjunct reading emerges with greater ease. Funakoshi 2016 argues that the Japanese equivalent of (5b) does not constitute evidence against a VVPE analysis for strings in Japanese in which internal arguments have gone missing because the adverbial reading in a downward entailing context can be drawn out by particular means.

It seems that we can facilitate the null adjunct reading in Japanese (a) if the antecedent sentence is also negated (see also Takahashi 2008); (b) if the antecedent and elliptical clauses are joined by a connective equivalent to *but* (Funakoshi 2014); or (c) if rich context is provided. These strategies also serve to facilitate the read-

ing in Hindi-Urdu, as in (6)-(8).¹

(6) Negated Antecedent:

- a. Ram-ne Chomsky-ka naya lekh dhyaan-se nahiiN paRh-a.
Ram-ERG Chomsky-GEN new writing carefully NEG read-PST.MSG
'Ram did not read the new paper by Chomsky carefully.'
- b. Raj-ne bhii nahiiN paRha.
Raj-ERG also NEG read-PST.MSG
'Raj also did not read (the new paper by Chomsky carefully).'

(7) Sentences connected with *but*

Ram-ne Chomsky-ka naya lekh dhyaan-se paRh-a magar
Ram-ERG Chomsky-GEN new writing carefully read-PST.MSG but
Raj-ne nahiiN paRh-a.
Raj-ERG NEG read-PST-MSG

'Ram read the new paper by Chomsky carefully, but Raj did not read (the new paper by Chomsky carefully).'

(8) Rich context:

Ram and Raj wash their parents' cars to get their allowance. Ram was thorough in his work, while Raj was not.

- a. Ram-ne gaaRi dhyaan-se dhoy-ii.
Ram-ERG car carefully wash-PRF.FSG
'Ram washed the car carefully.'
- b. Raj-ne nahiiN dhoy-ii. Yeh gaaRi jis-ko Raj-ne dhoy-aa
Raj-ERG NEG wash-PRF.FSG that car.M REL-ACC Raj-ERG wash-PRF.MSG
abhii bhii thooRi thooRi ganDi rah gay-ii
now also little little dirty.F stay go-PRF.FSG
'Raj did not wash (the car carefully). The car Raj washed still remained a bit dirty.'²

Indeed, Ayesha Kidwai (p.c.) reports that for her, simply additional knowledge about Raj's habitual carelessness is sufficient to facilitate the null adjunct reading in sentences like (5b) above.

¹Thanks to Ayesha Kidwai for her judgments and discussion of these examples.

²There is a related observation concerning the degraded status of following clauses containing pronouns which refer to the missing internal argument in the alleged VVPE environment.

- (i) Ram-ne aapne cake dhyaan-se banay-ee, magar Raj-ne nahiiN banay-ee, aur is-liye wo
Ram-erg self's cake carefully made-prf.pl but Raj-erg neg made-prf.pl and this-for 3sg
mazedar nahiiN thee!
delicious neg be.pst.pl
'Ram baked his cake carefully, but Raj did not bake (his cake; ?carefully), and for this reason it_i was not delicious!

Unsurprisingly these judgments are subject to the same variability and facilitation as the null adjunct reading in the text above, so in the interests of space I will omit their discussion here.

Crucially, if the internal argument is not missing, the null adjunct reading cannot be drawn out by any means and remains unavailable:

- (9) Ram-ne Chomsky-ka naya lekh dhyaan-se paRh-a magar
Ram-ERG Chomsky-GEN new writing carefully read-PST.MSG but
 Raj-ne naya lekh nahiiN paRh-a.
Raj-ERG new writing NEG read-PST.MSG
 ‘Ram read the new paper by Chomsky carefully, but Raj did not read did not read the new paper (NOT included: ‘carefully’).³

Since it is possible to make the null adjunct interpretation more accessible in Hindi-Urdu, we can conclude that the elliptical clauses in (6)-(8) represent true instances of VVPE, in which the elided VP includes both the internal argument and an adverbial. This establishes that seeming failure of the adverb test in (5b) does not provide clear argument against VVPE analyses of elliptical strings in these languages. However, we have as of yet no clear understanding as to why the null adverbial reading should be inaccessible for (5b), why the mechanisms above facilitate the reading, and what this might mean for the interaction of verb movement and ellipsis in a language like Hindi-Urdu. The next section addresses these questions.

3 POLARITY AND MAXELIDE

A possible explanation for the inaccessibility of the adverbial interpretation for the negated elliptical sentence may be found in the interaction between verb movement, negation, and polarity. The solution to the puzzle emerges more clearly if we consider the contrast between the availability of the null adjunct reading in the responses (10a) and (10b).

- (10) Sita-ne kah-aa ki Ram Chomsky-ka naya lekh dhyaan-se
Sita-ERG say-PST.MSG that Ram Chomsky-GEN new writing carefully
 paR-eega
read-FUT.MSG
 ‘Sita said that Ram will read the new article by Chomsky carefully.’

³An additional useful data point comes courtesy of Jim McCloskey (p.c.) who suggests that if the “low” (restitutive) reading (Johnson 2004) is available for a missing adverb like again (in Hindi-Urdu, *dubara*) in an alleged VVPE site, then that reading must be the one obtained from inclusion in the VP-ellipsis. As (i) illustrates, the restitutive reading does seem to be available. Thanks to Ayesha Kidwai and Rajesh Bhatt for their judgements.

- (i) Ram-ne apna darwazaa dubara khol-aa, magar Raj-ne nahiiN khol-aa.
Ram-ERG self's door again open-PRF.M but Raj-ERG NEG open-PRF.M
 ‘Ram opened his door again, but Raj did not (open his door again)’ = Raj did not return his door to the open state.

- a. Raj nahiiN paRh-eega
Raj NEG read-FUT.MSG
 ‘Raj will not read.’ = ‘Raj will not read the new article (?* carefully).’
- b. magar Raj nahiiN
but Raj NEG
 ‘But not Raj’ = ‘But Raj will not read the new article ?(carefully).’

For (10a), as for (5b) above, in which the subject, negation, and verb remain, the null adjunct reading is often difficult to obtain without additional context. By contrast, in (10b), which contains only the subject and a negative particle, the reading including the adverb *carefully* is not only available, but in fact the dominant reading. Let us first investigate the ellipsis processes at work in (10b), for which the null adjunct reading is easy to obtain, in order to better approach (10a).

The analysis I propose below for (10a-b) makes use of well-established approaches to Hindi-Urdu clause structure. Following a range of previous work (Bhatt 2003, 2005; Kumar 2006; Butt and Ramchand 2005; Manetta 2011; among many others), I adopt the basic structure below for a simple Hindi-Urdu clause as in (11):

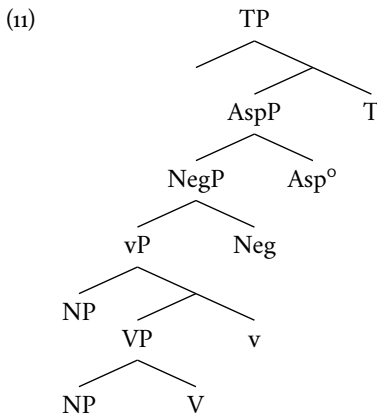

I also assume regular syntactic movement of the verb and all inflectional material via head adjunction to the Aspect head, as argued for in Manetta (to appear) (see similar proposals adopted in Kumar 2006 and Bhatt and Dayal 2007), and movement of the subject to Spec, TP (along with Bhatt 2003, 2005; Manetta 2011). I follow Dwivedi (1991) and Bhatt and Dayal (2007) in the claim that negation in Hindi-Urdu heads a right-headed maximal projection NegP which is located between vP and AspP (contra Kumar 2006). The verbal complex moves through negation into Asp° when present, creating either the word order NEG+verb+auxiliaries or verb+NEG+auxiliaries in negated sentences (also as in Baker 2014).

It is important to note that sentential negation and the discourse particle serving as a negative response to a question are the same lexical item in Hindi-Urdu: *nahiiN*.

- (12) a. *kyaa Ram Chomsky-ka naya lekh dhyaan-se paR-eega*
Q Ram Chomsky-GEN new writing carefully read-FUT.MSG
 'Will Ram read the new article by Chomsky carefully?'
- b. *HaaN / nahiiN*
yes / no
 'Yes'/'no' = 'Ram will/will not read the new article by Chomsky carefully'
- c. *Ram Chomsky-ka naya lekh dhyaan-se nahiiN paR-eega.*
Ram Chomsky-GEN new writing carefully NEG read-FUT.MSG
 'Ram will not read the new article by Chomsky carefully.'

With this background in mind, let us first consider the response in (10b), repeated here:

- (10b) *magar Raj nahiiN*
but Raj NEG
 'But not Raj' = 'But Raj will not read the new article (carefully).'

I propose that the constituent elided in (10b) is TP - to use the term in Gribanova (2017), this is contrastive polarity ellipsis (see also Vicente 2006; Kazenin 2006; Morris 2008; Barros 2014). Stranded outside the ellipsis site are the negative discourse particle *nahiiN* in the Polarity (Pol) head, and a contrastive phrasal remnant (in this case the subject) in the specifier of PolP.

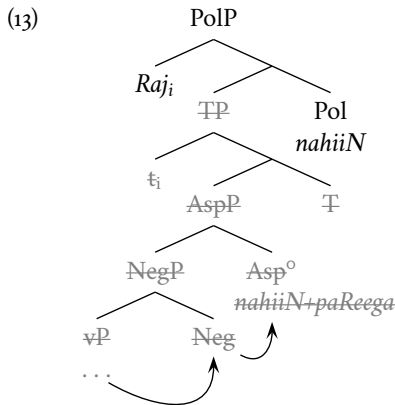

The adverbial reading will naturally emerge here, as the adverb is well-contained within the elided TP.⁴ In the interests of space, I gloss over interesting questions

⁴This account assumes agreement in polarity between the Pol and Neg head (as discussed in Gribanova 2017 for Russian). The Neg head is spelled out morphophonologically as sentential negation (*nahiiN*), while the Pol head may be spelled out as a discourse particle of the relevant polarity when present (*haaN/nahiiN*). Though space constraints prevent a thorough investigation of negation and negative polarity items here, this view of agreement between Pol and Neg could help to explain the facts of NPI licensing in Hindi-Urdu: in particular, the fact that NPIs are licensed in subject position in the language (of long interest: e.g. Mahajan 1990b; Lahiri 1998; Kumar 2006). I leave this issue to further research.

prompted by the analysis in (13) to make progress toward an account of the failure of the adverb test which is the focus of this paper.

Let us now turn to the mysterious (10a), which features the subject, negation, and the fully inflected verb.

- (10a) Raj nahiiN paRh-eega.
Raj *NEG* *read-FUT.MSG*
 ‘Raj will not read.’ = ‘Raj will not read the new article (?* carefully).’

Under the account in Manetta, to appear, (10a) has two possible analyses: one featuring a null/missing internal argument and one featuring VPE. Of course, if the internal argument has gone missing on its own, the unavailability of the null adjunct reading is easily explained since no adverb is present in the clause at all. If, on the other hand, the internal argument is missing as the result of being contained within a larger ellipsis site, then the reading should in theory be available. In what follows I show that under unmarked circumstances there are actually no elliptical parses for (10a).

If the string in (10a) were derived via ellipsis, the entire verbal complex, including the verb root, inflectional material, and sentential negation must remain outside the ellipsis site. I propose here that in an environment of contrastive polarity which lacks the negative discourse particle, the entire verbal complex (including negation when present) may be attracted to the Polarity head (Holmberg 2001; Gribanova 2017). In this case, there would actually be two constituents of different sizes which could conceivably undergo ellipsis: vP and TP (bolded in the tree below).

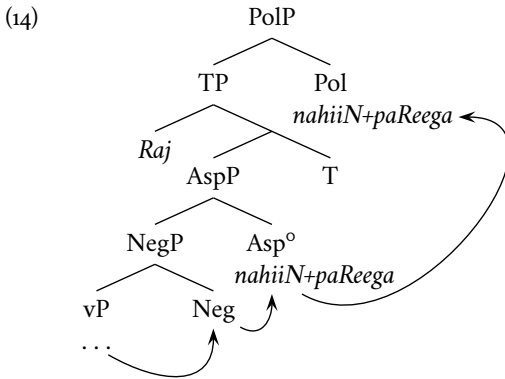

This configuration would certainly permit TP ellipsis, but in that case the subject should be missing, generating not (10a), but instead a string in which the subject is not present at all, as in (15):

- (15) magar nahiiN paRh-eega
but *NEG* *read-FUT.MSG*
 ‘but (he) will not read (?carefully)’⁵

⁵Note that there are also two possible analyses for the string in (15). Since both null external and

While this string is certainly grammatical, the missing agent of the reading action must be identical to that in the antecedent (Ram). This is not a scenario in which Ram and Raj are being contrasted, and thus not a scenario in which (10a) can be produced.

But what about vP ellipsis? Why is it not possible in (14)? I argue here, alongside Gribanova 2017, that vP ellipsis is impossible here due to the restriction on ellipsis size termed MaxElide (Merchant 2008). Classically this constraint is invoked to block verb phrase ellipsis in environments in which sluicing is possible. Under Takahashi and Fox's (2005) formulation of the constraint, in cases where there is a variable in the elided constituent that is bound from outside (rebinding), there must be a parallelism domain (PD) containing the variable's binder which is semantically identical with another constituent (modulo focus-marked constituents) (Takahashi and Fox 2005:229). MaxElide then requires the constituent targeted for ellipsis to be the largest possible constituent dominated by the PD. Hartman (2011) extends the constraint to apply to head movement in addition to phrasal movement. To the extent that we understand head movement to be a syntactic phenomenon, it should leave traces interpreted as variables subject to MaxElide. Gribanova 2017 argues that syntactic head movement to Pol in Russian leaves behind a variable, forcing the PD to be large enough to include the binder. For this reason, TP ellipsis but not vP ellipsis is possible in these environments, since we must choose the largest elliptical constituent in the PD. I propose here that an analogous situation pertains in (14): given that the parallelism domain must include the head which has moved to Pol, only TP ellipsis is possible since vP ellipsis would violate MaxElide.

Given this analysis, it is impossible for the string in (10a) to be generated by an instance of vP or TP ellipsis. The only way to generate this particular string is via a null/missing internal argument, and this is why for most speakers, the null adjunct reading is not readily available in an unmarked context. In this view, (10a) is quite different from (10b) (or indeed (12b) or (15)) in that it does not represent an instance ellipsis at all.

We must now ask why the null adjunct reading in a string equivalent to (10a) can be facilitated with additional context or a change in the nature of the antecedent clause. Given the analysis above, when the null adjunct reading does emerge, it must be because there exists a Pol head which hosts the V+v+Asp+NEG complex and may also host the contrastive topic in Spec, PolP. The TP must then be elided, stranding the contrastive topic and verbal complex. The large ellipsis site necessarily contains the adverb.

internal arguments are available in the language, (15) could be derived without ellipsis having roughly the structure: [TP *pro*_{RAM} *pro*_{ARTICLE} NEG+*VERB*.] In this case, the adverb *carefully* is not present, so the reading is not available. I believe the interference of this possible parse for (15) is what renders the adverb less accessible here.

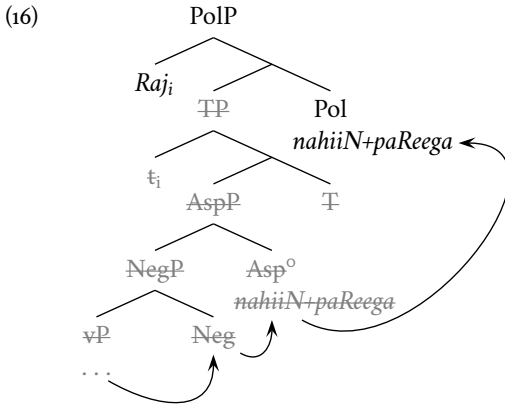

Given this view, what then is the source of the variation we see in the accessibility of the null adjunct reading, both within and across individual speakers (and indeed, across a range of unrelated languages)? We can speculate that the Pol head in (16), which attracts a contrastive topic and the verbal complex, might be in the lexicon of most speakers for scenarios of very strong contrast between topics, but not otherwise. If the contrastive topic and verbal complex are found this high in the structure, TP ellipsis is possible. This would explain why rich context would render the null adjunct reading far more accessible. Alternatively, it might be that there is inter-speaker variation with respect to this head, and it is not present in the lexicon of every speaker (or in every variety of the relevant language). While an extensive empirical investigation would need to be done to establish the precise facts, the analysis presented here provides a way of couching this variation in the syntax of ellipsis.

The analysis proposed in (14) and (16) suggests that other strongly contrastive constituents (non-subjects) should be able to occupy Spec, PolP with similar results.

- (17) Context: We think that Ram will read all of the assigned works by Chomsky, but with varying levels of attention.

Ram *Aspects* dhyaan-se paRh-eega
 Ram *Aspects carefully* read-FUT.MSG

'Ram will read *Aspects* carefully ...'

- a. ... magar *Syntactic structures* nahiiN paRh-eega.
 but *Syntactic structures* NEG read-FUT.MSG
 'but *Syntactic structures* (he) won't read (carefully)'
- b. ... magar *Syntactic structures* nahiiN.
 but *Syntactic structures* NEG
 'but not *Syntactic structures*.' = 'but he won't read *Syntactic structures*?(carefully)'

Since the null adverbial reading can be facilitated in (17) by rich context just as it can in examples in which the subject is contrasted, we have further support that these are the scenarios in which we have discourse-driven movement of a contrastive topic and the verbal complex to a high position followed by ellipsis of TP (easily containing the adverbial).

To summarize the new proposal, under conditions of contrastive polarity, Hindi-Urdu has several Polarity heads. The first may introduce the negative discourse particle, in addition to a contrastive phrase in its specifier. Ellipsis of the TP dominated by this Pol head will lead to responses like that in (10b) above. In addition, Hindi-Urdu has a separate Polarity head which can attract the verbal complex, made concrete here via the feature [v], accompanied by the EPP subfeature which serves to trigger head movement. This Polarity head also possess the [E] feature, prompting ellipsis of TP:

- (18) POL: [E]
 [v, EPP]

In environments of very strong contrast (and the threshold may be different for different speakers or for different languages/varieties), a second Pol head may be available:

- (19) POL: [E]
 [v, EPP]
 [TOPIC, EPP]

Through this approach to understanding the interaction between adverbs, polarity, and ellipsis, we can solve both the initial puzzle of the inaccessibility of the null adjunct reading in a specific context, and the variability we find in its facilitation in a wide range of languages with VVPE.

4 SUMMARY AND ONGOING RESEARCH

The analysis proposed in the present paper offers a solution to the puzzling failure of the so-called “adverb test” in languages which have otherwise been argued to exhibit VVPE. At first glance, the difficulty in obtaining the null adjunct reading in downward entailing environments would suggest that VVPE may not be available in languages like Farsi, Japanese, Russian, and Hindi-Urdu. But given enough context or an appropriate antecedent, the null adjunct reading can be facilitated, illustrating that some other constraint is at work here.

I propose in this paper that Hindi-Urdu, like Russian, features a Polarity head dominating TP, and capable of hosting either the negative discourse particle *nahiiN* or the negated verbal complex in strongly contrastive negative sentences. Importantly, it cannot host both:

- (20) a. Ram Chomsky-ka naya lekh dhyaan-se paR-eega
 Ram Chomsky-GEN new writing carefully read-FUT.MSG
 ‘Ram will read the new article by Chomsky carefully . . . ’

- b. * *magar Raj nahiiN nahiiN paRh-eega*
but Raj NEGPART NEG read-FUT.MSG
 Intended: ‘but Raj will not read (the new article by Chomsky (carefully)).’

I have claimed here (alongside Gribanova 2017) that in contexts in which the verb moves as high as Pol, only TP ellipsis is available due to the restriction on ellipsis termed MaxElide, forcing ellipsis of the largest possible constituent. This means that the problematic string which would at first glance appear to indicate failure of the adverb test, is not a string generated by ellipsis at all, but instead by a missing internal argument. No adverb is present, so the reading including the adverb is not expected. For many speakers, context is needed to provide a scenario of sufficient contrast to warrant a version of Pol that can also attract a contrastive topic to its specifier. In this case, TP ellipsis will strand the contrastive topic and verbal complex, and the null adjunct reading will emerge. I have posited here that it is availability of this Pol head in the lexicon of a speaker (and the discourse pressures which condition it) that is the source of variation in the availability of the null adjunct reading in Hindi-Urdu.

This apparent failure of the adverb test thus provides an opportunity to further our investigation of head movement in a head-final language. In head-final languages like Hindi-Urdu, the nature of the composition of the morphologically and lexically complex verb is difficult to probe; any head movement would typically be string-vacuous as all the heads of the verbal complex appear on the right. A number of researchers have assumed some degree of verb movement for various reasons (e.g. Kumar 2006, Bhatt and Dayal 2007, Bhatt 2008). However, it is challenging to find direct evidence that verb movement has taken place, and tests for positioning of adverbs, post-verbal material, and subjects relative to the verb are unrevealing when the verbal complex is clause-final (Pollock 1989; McCloskey 1991; Depiante and Vincente 2012). The position of negation has the potential to be more useful, but as sentential negation can appear either immediately preceding or immediately following the inflected verb in the verbal string in Hindi-Urdu, these tests have not provided unambiguous information (Kumar 2006).

As other researchers working on head-final languages have suggested (Otani and Whitman 1991; Koisumi 2000; Simpson and Syed 2013), VVPE has the potential to provide just such evidence. The availability of VVPE in Hindi-Urdu demonstrates that the verb must move at least outside of the vP (Manetta, to appear). If the solution to the failure of the adverb test is on the right track, the verb can under certain discourse conditions move even higher, feeding contrastive polarity ellipsis (ellipsis of TP). Though more research is certainly required, the analysis I propose here has the potential to be extended to a number of languages in which the variable availability of adverb interpretations in negated elliptical structures remains a puzzle.

This small project contributes to the wider program of recent work investigating the nature of head movement and its role in the syntax (Chomsky 2001; Roberts 2010; Hartman 2011; LaCara 2016; McCloskey 2016; Keine and Bhatt 2016;

Manetta, to appear, Gribanova and Mikkelsen, this volume). Discourse-driven head movement to a relatively high point in the clause (Harizanov and Gribanova 2017; Gribanova 2017) may well be at the heart of the apparent failure of the adverb test.

REFERENCES

- Baker, Mark. 2014. Pseudo-Noun Incorporation as covert noun incorporation: linearization and crosslinguistic variation. *Language and Linguistics* 15: 5-46.
- Bhatt, Rajesh. 2003a. Lecture Handouts: Topics in the Syntax of Modern Indo Aryan Languages. MIT, Spring 2003.
- Bhatt, Rajesh. 2005. Long Distance Agreement in Hindi-Urdu. *Natural Language and Linguistic Theory* 23:757-807.
- Bhatt, Rajesh and Veneeta Dayal. 2007. Rightward Scrambling as Rightward Remnant Movement. *Linguistic Inquiry* 38:287-30.
- Butt, M., Jabeen, F., & Bögel, T. Verb cluster internal wh-phrases in Urdu: Prosody, syntax and semantics/pragmatics. *Linguistic Analysis* 40 (3-4). 445-487.
- Butt, Miriam, and Tracy Holloway King. 1997. Null Elements in Discourse Structure. In *Papers from the NULLS Seminar*, ed. K.V. Subbarao. Delhi: Moti Lal Banarsi Das.
- Butt, Miriam and Gillian Ramchand. 2005. Complex Aspectual Structure in Hindi/Urdu. In *The Syntax of Aspect*, Nomi Ertishik-Shir and Tova Rappaport (eds). 117-153. Oxford: OUP.
- Chomsky, Noam. 2001. Derivation by phase. In *Ken Hale. A life in language*, ed. M. Kenstowicz. 1-52. Cambridge, Mass.: MIT Press.
- Davison, Alice. 1999. Empty categories: anaphoric vs. pronominal coindexing, ms. University of Illinois.
- Davison, Alice. 2005. Phrasal predicates: How N combines with V in Hindi/Urdu. In Tanmoy Bhattacharya (ed.) *Yearbook of South Asian Languages and Linguistics*, 83-116. Berlin: Mouton DeGruyter.
- Davison, Alice. 2013. Empty Categories in the Hindi-Urdu *binaa* participial clause. *Lingua Posnaniensis*, vol. LV (2)/2013. The Poznań Society for the Advancement of the Arts and Sciences. 25-39.
- Dayal, Veneeta. 2003. Bare Nominals: Non-specific and Contrastive Readings under Scrambling, in Simin Karimi (ed.) *Word Order and Scrambling*, Malden, MA: Blackwell Publishers.
- Dayal, Veneeta. 2011. Bare Noun Phrases. Maeinborn, von Heusinger and Portner (eds), *Semantics: An International Handbook of Natural Language Meaning*, 33.2 1087-1108. Berlin: de Gruyter.
- Depiante, Marcela, and Luis Vicente. 2012. El movimiento y la morfología del verbo. In Brucart and Gallego (eds.) *El movimiento de constituyentes*, 95-106. Madrid: Visor Libros.
- Doron, Edit. 1991. *V-movement and VP ellipsis*. Jerusalem: The Hebrew University of Jerusalem.

- Dwivedi, Veena. 1994. *Syntactic Dependencies in Relative Phrases in Hindi*. PhD dissertation, University of Massachusetts, Amherst.
- Funakoshi, Kenshi. 2016. Verb-Stranding Verb Phrase Ellipsis in Japanese. *Journal of East Asian Linguistics* 25(2): 113-142.
- Goldberg, Lotus. 2005. *Verb-stranding VP ellipsis: a cross-linguistic study*. PhD dissertation, McGill University, Montréal.
- Gribanova, Vera. 2013a. Verb-stranding verb phrase ellipsis and the structure of the Russian verbal complex. *Natural Language and Linguistic Theory* 31(1): 91-136.
- Gribanova, Vera. 2013b A new argument for verb-stranding verb phrase ellipsis. *Linguistic Inquiry* 44(1): 145-157.
- Gribanova, Vera and Boris Harizanov. 2016. Whither head movement? Presented at the workshop on the Status of Head Movement in Linguistic Theory. Stanford University. September, 2016.
- Gribanova, Vera. 2017. Head movement and ellipsis in the expression of Russian polarity focus. *Natural Language and Linguistic Theory* 35.1, 1-43.
- Gribanova, Vera And Line Mikkelsen. 2018. On the interaction of head movement and ellipsis in Danish. This volume.
- Hardt, Daniel. 1993. *Verb Phrase Ellipsis: form, meaning and processing*. Ph.D. dissertation, University of Pennsylvania.
- Harizanov, Boris and Vera Gribanova. 2017. Post-syntactic head movement in Russian predicate fronting. Annual Meeting of the LSA, Austin, TX; January 5-8, 2017.
- Hartman, Jeremy. 2011. The semantic uniformity of traces: Evidence from ellipsis parallelism. *Linguistic Inquiry* 42: 367-388.
- Hankamer, Jorge, and Ivan A. Sag. 1976. Deep and surface anaphora. *Linguistic Inquiry* 7: 391-426.
- Hoji, Hajime. 1998. Null objects and sloppy identity in Japanese. *Linguistic Inquiry* 28: 127-152.
- Hoji, Hajime. 2003. Surface and Deep Anaphora, Sloppy Identity, and Experiments in Syntax. In Barss, A. and T. Langendoen (eds), *Anaphora: A Reference Guide*, eds. Malden, MA: Blackwell.
- Holmberg, Anders. 2001. The syntax of yes and no in Finnish. *Studia Linguistica* 55(2): 140-174.
- Johnson, Kyle. 2001. What VP-ellipsis can do, and what it can't, but not why. In Baltin, M. and C. Collins (eds.) *The Handbook of Contemporary Syntactic Theory*, 439-479. Oxford: Blackwell.
- Johnson, Kyle. 2004. How to be Quiet. In Adams, Nikki, Adam Cooper, Fey Parrill and Thomas Wier (eds.), *Proceedings from the 40th Annual Meeting of the Chicago Linguistics Society*, 1-20.
- Jouitteau, Mélanie. In prep. Tense Second effects in Breton linear V2: evaluating the arguments for a post-syntactic analysis. In Biberauer, Teresa, Sam Wolfe and Rebecca Woods (eds). *Rethinking Verb Second*. Oxford: Oxford University Press.
- Karimi, Simin. 1999a. A Note on Parasitic Gaps and Specificity. *Linguistic Inquiry* 30: 704-713.

- Karimi, Simin. 1999b. Specificity Effect: Evidence from Persian. *Linguistic Review* 16: 125-141.
- Kazenin, Konstantin. 2006. Polarity in Russian and Typology of Predicate Ellipsis. Ms. Moscow State University.
- Keine, Stefan & Rajesh Bhatt. 2016. Interpreting verb clusters. *Natural Language and Linguistic Theory* 34: 1445-1492.
- Koisumi, Masatoshi. 2000. String Vacuous Overt Verb Raising. *Journal of East Asian Linguistics* 9, 227-285.
- Kumar, Rajesh. 2006. *Negation and Licensing of Negative Polarity Items in Hindi Syntax*. New York: Routledge.
- Lacara, Nicholas. 2014. Why there is no verb-stranding in (Mainland) Scandinavian. 29th Comparative Germanic Syntax Workshop University of York, UK, 26 September, 2014.
- Lacara, Nicolas. 2016. A Germanic verb movement paradox. Workshop on the Status of Head Movement in Linguistic Theory. Stanford, CA, September 15, 2016.
- Lahiri, Utpal. 1998. Focus and negative polarity in Hindi. *Natural Language Semantics* 6: 57-123.
- Mahajan, Anoop. 1990a. The A/A-bar distinction and movement theory. PhD dissertation, MIT, Cambridge, Mass.
- Mahajan. Anoop. 1990b. LF Conditions on Negative Polarity Licensing. *Lingua* 80: 333-348.
- Manetta, Emily. 2011. *Peripheries in Kashmiri and Hindi Urdu: The syntax of discourse-driven movement*. series: Language Faculty and Beyond, Amsterdam: John Benjamins.
- Manetta, Emily. 2012. Reconsidering rightward scrambling: Postverbal constituents in Hindi-Urdu. *Linguistic Inquiry* 43:1, 43-74.
- Manetta, Emily. 2014. The shape of the causative verbal domain: evidence from Kashmiri. *Syntax* 17:3: 235-168.
- Manetta, Emily. 2016. Verb phrase ellipsis in Hindi complex predicates. Presented at the International Conference on Hindi Studies (INALCO), Paris, France. Sept 14-16.
- Manetta, Emily. To appear. Verb phrase ellipsis in complex predicates in Hindi-Urdu. *Natural Language and Linguistic Theory*.
- Martins, Ana-Maria. 1994. Enclisis, VP-deletion and the nature of sigma. *Probus* 6: 173-205.
- Matos, G. 1992. *Construções de Elipse do predicado em Português - SV Nulo e Despojamento*. PhD Dissertation. Lisboa: Universidade de Lisboa.
- McCloskey, James. 1991. Clause structure, ellipsis and proper government in Irish. *Lingua* 85: 259-302.
- McCloskey, James. 2016. Interpretation and the Typology of Head Movement: A Re-Assessment. Workshop on the Status of Head Movement in Linguistic Theory. Stanford, CA, September 15, 2016.
- Merchant, Jason. 2001. *The syntax of silence: Sluicing, islands and the theory of ellipsis*. Oxford: Oxford University Press.

- Merchant, Jason. 2008. 'Variable island repair under ellipsis'. Topics in ellipsis, ed. by Kyle Johnson, 132-153. Cambridge: Cambridge University Press.
- Merchant, Jason. 2013. Voice and ellipsis. *Linguistic Inquiry* 44(1): 77-108.
- Merchant, Jason. 2018. Verb-stranding predicate ellipsis in Greek. This volume.
- Morris, Amanda. 2008. Polarity Ellipsis and Negative Stripping. Unpublished manuscript. <http://babel.ucsc.edu/~hank/PolarityEllipsisandNegStripping.pdf>.
- Oku, Satoshi. 1998. *A theory of selection and reconstruction in the minimalist perspective*. PhD dissertation, University of Connecticut.
- Otani, Kazuyo, and John Whitman. 1991. V-Raising and VP-ellipsis. *Linguistic Inquiry* 22: 345-358.
- Pollock, Jean-Yves. 1989. Verb movement, universal grammar, and the structure of IP. *Linguistic Inquiry* 20: 365-424.
- Roberts, Ian. 2010. *Agreement and head movement*. Cambridge, MA: MIT Press.
- Ross, John Robert. 1969. Auxiliaries as main verbs. *Studies in Philosophical Linguistics* 1: 77-102.
- Sailor, Craig. 2014. *The variables of VP-ellipsis*. PhD Dissertation, University of California, Los Angeles.
- Sailor, Craig. Forthcoming. The Typology of Head Movement and Ellipsis: a reply to Lipták & Saab. *Natural Language and Linguistic Theory*.
- Saito, Mamoru. 1985. *Some asymmetries in Japanese and their theoretical implications*. PhD diss., MIT Press, Cambridge.
- Simpson, Andrew, Arunima Choudhury and Mythili Menon. 2013. Argument Ellipsis and the licensing of covert nominals in Bangla, Hindi and Malayalam. *Lingua* 134:123-138.
- Simpson, Andrew and Saurov Syed. 2014. Finiteness, negation, and the directionality of headedness in Bangla. *Natural Language and Linguistic Theory* 32:231-161.
- Takahashi, Daiko. 2008. Quantificational null objects and argument ellipsis. *Linguistic Inquiry* 39:307-326.
- Takahashi, Shoichi, and Danny Fox. 2005. MaxElide and the re-binding problem. In Georgala, Effi and Jonathan Howell (eds) *Semantics and Linguistic Theory (SALT) 15*, 223-240. Ithaca: CLC Publications.
- Toosarvandani, Maziar. 2009. Ellipsis in Farsi complex predicates. *Syntax* 12(1):60-92.
- Toosarvandani, Maziar. To Appear. Persian. In van Craenenbroeck, Jeroen and Tanja Temmerman (eds) *The Oxford handbook of ellipsis*. Oxford: Oxford University Press.
- Vicente, Luis. 2006. Short negative replies in Spanish. In Jeroen van de Weijer and Bettelou Los (eds.), *Linguistics in the Netherlands* 23: 199-211. Amsterdam: John Benjamins.

Verb-stranding predicate ellipsis in Greek, implicit arguments, and ellipsis-internal focus^{*}

Jason Merchant
University of Chicago

1 DISTINGUISHING AMONG THE MISSING

When expected arguments of predicates go missing, it can be a challenge to analyze why: are missing elements suppressed in the argument projection of a predicate, or are they actually projected but merely unpronounced? If the latter, is it because the language has in its lexicon a set of null pronouns or null indefinite arguments (or, equivalently, a set of lexical processes that return predicates with such arguments added or saturated), or is it because a phrase containing the elements has been elided? I show that all three possibilities exist in standard modern Greek (henceforth, Greek): some arguments are suppressed in the lexicon, some are projected, but realized as null nominal phrases, and some are missing because they are inside a predicate which has undergone phrasal ellipsis. This last option interacts with an independent property of Greek, the movement of the main verb to a higher functional projection, to yield what McCloskey (1991) called verb-stranding verb phrase ellipsis, more recently named verb-stranding ellipsis (VSE) in Gribanova (2017a), a more flexible terminology I will adopt here. I show that Greek is like Russian, and unlike Irish, in allowing for mismatched verbs, and that this conclusion is in alignment with that reached in Gribanova (2017b). Finally, I propose a possible way to understand the difference between Greek and Irish: in Irish, unlike in Greek (and the other languages with VSE), the realization of focus on the verb is subject to a number of peculiar prosodic and other constraints that conspire to prevent simple verb stem mismatches.

Studying ellipsis is much like studying black holes: we do not have tools to probe them directly, but rather we learn about their properties by examining

^{*}It is more than a pleasure and an honor to present this small piece in gratitude to Jim, whose personal and professional example has inspired me for the better part of three decades. His brilliant combination of painstaking data collection, insightful formal analysis, and scrupulous scholarship is a model for us all. It is no exaggeration to say that without his guidance, in class and out of it, I would not have become a syntactician. He has also been more than a model citizen of the field, with an unmatched gentility and good-naturedness; in a particularly memorable act of good will, Jim once even defended Ringo Starr's one and only Beatles-era drum solo (the famous eight measures of alternating quarter notes and sixteenths on 'The End'); truly the man has a heart of gold.

their effects on surrounding material (Thomas et al. 2016). When something is gone from the linguistic form, but nevertheless speakers produce and hearers interpret the resulting structure with a determinate (within reason) meaning, given a particular linguistic context, it is up to the analyst to discover the mechanisms that give rise to these meanings. One of the ways we do this is to determine whether the syntactic properties of the missing element are the same as those of its putative overt counterpart. When these align, Ockam’s razor impels us to conclude that the element is present, but unpronounced. When these properties do not align, our task is harder, but application of Ockam’s razor in such cases suggests that the element is not there.

2 PREDICATE ELLIPSES AND V-TO-T MOVEMENT

Greek allows the ellipsis of a post-copular predicate, marked in the following examples with the placeholder Δ . Adjectival predicates, nominal predicates, and prepositional predicates can all be absent after *ime* ‘be’, provided that an antecedent is available (see Merchant 2014).¹

- (i) a. O Petros ine ikanos, ala o Alexandros dhen ine Δ .
the Petros is capable.m.sg but the Alexander not is
 ‘Petros is capable, but Alexander isn’t.’
- b. O Petros ine kalos adherfos, ala o Kostas dhen ine Δ .
the Petros is good.masc brother.masc but the Kostas not is
 ‘Petros is a good brother, but Kostas isn’t.’
- c. I Maria ine sto dhomatio, ala i Anna dhen ine Δ .
the Maria is in.the room but the Anna not is
 ‘Maria is in the room, but Anna isn’t.’

But Greek does not have ellipsis of the verb phrase complement to the perfect auxiliary *exo* ‘have’, nor does it allow for sentential negation to appear by itself (*dhen* is a clitic on the finite verb complex).

- (2) a. *I Maria exi teliosi tin ergasia tis, ke i Anna exi Δ , episis.
the Maria has finished the homework her and the Anna has too
 (‘Maria has finished her homework, and Anna has, too.’)
- b. *O Petros ine ikanos, ala o Alexandros dhen Δ .
the Petros is capable.m.sg but the Alexander not
 (‘Petros is capable, but Alexander isn’t.’)

¹For her many years of judgments on these and countless other, similar examples, my undying thanks to the infinitely patient Anastasia Giannakidou. Thanks also to the dozens of other Greek speakers who have heard various parts of this material over the past twenty years and supplied valuable feedback and judgments, especially the audience at the 5th annual Midwest Workshop on Greek Linguistics in 2016, including Natalia Pavlou, Marika Lekakou, and Marina Terkourafi. Thanks also to Line Mikkelsen, Idan Landau, and Anikó Lipták for timely comments on an earlier draft.

These facts are most readily understandable if the target of ellipsis in Greek is a predicate phrase, which we can conveniently identify with Bowers' (1993, 2002) PredP. For an example such as (1a), then, we have the following structure, where strikethrough indicates the node targeted for non-pronunciation (the position of the clitic negation *dhen=* and any potential internal structure of the verb+tense *ine* are not relevant here):

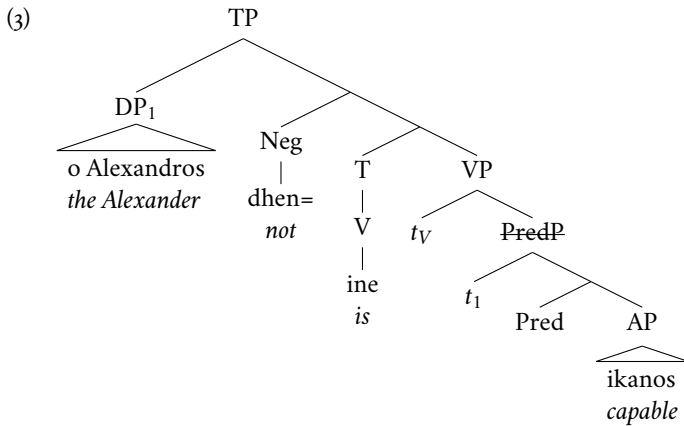

Clear evidence that PredP is elided, and not merely suppressed with its content somehow understood, comes from extraction of internal arguments of the elided predicate head. In (4a), the contrastively focused PP argument of *ikanos* 'capable', *ja dholofonia* literally 'for murder', is fronted to the clause-initial focus position in the second clause. This PP is headed by a preposition, *ja*, that is lexically selected by the adjective *ikanos*—its appearance here is not predictable from its own meaning or from the meaning of *ikanos*, nor is it a default preposition. Standard assumptions about such idiosyncractic lexical selection, therefore, require that there be in the syntactic representation of (4a) a head that selects it. This full structure is precisely what an ellipsis analysis makes available, as shown in (4b).

- (4) a. O Alexis *ine sigura ikanos ja kapja englimata, ala ja dholofonia,*
the Alexis is surely capable for some crimes but for murder
dhen ine.
not is
 'Alexis is surely capable of *some crimes*, but of *murder*, he isn't.'

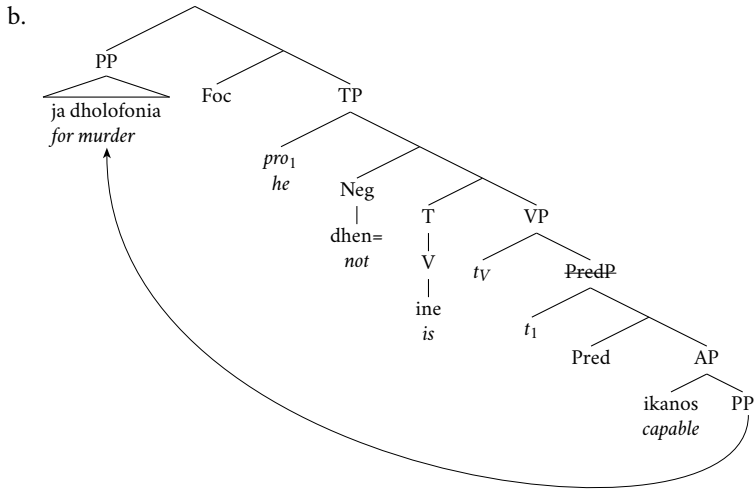

Additional evidence that the complement of *ine* is elided (that is, that it is ‘surface anaphoric’ in the sense of Hankamer & Sag 1976 or is true ellipsis, in the sense of Sag & Hankamer 1984), and not merely suppressed by a general mechanism of argument suppression (that is, that it is not a kind of ‘deep anaphor’ in Hankamer and Sag’s sense, or model-theoretic anaphora in Sag and Hankamer’s) comes from the differing interpretations available to the two structures. When the AP is elided, the predicate of the second conjunct is interpreted exactly as the first is. This can give rise to covarying or coreferential readings with pronouns in (5b), for example:

- (5) a. O Alexis *ine* *ikanos* ja dholofonia, ala o Petros dhen *ine*.
the Alexis is capable for murder but the Petros not is
 ‘Alexis is capable of murder, but Petros is not capable of murder.’
- b. O Alexis *ine* *perifanos* ja ton jo tu, ala o Petros dhen *ine*.
the Alexis is proud of the son his but the Petros not is
 ‘Alexis₁ is proud of his_{1/2/3} son, but Petros₂ is not proud of his_{1/2/3} son.’

When just the PP internal argument to an adjective is missing, the adjective receives a general interpretation, with its internal argument specified only pragmatically. This means that the internal argument could take as its value *murder* or *his son*, as in (5) above, but it need not; by Gricean principles, the availability of the expressions in (5) in fact make this reading highly marked. The most natural interpretation of the following examples is precisely that of their English counterparts, with an unspecified internal argument, and the predicate attributing a generic individual-level property to the subject.

- (6) a. O Alexis *ine* *ikanos* ja dholofonia, ala o Petros dhen *ine* *ikanos*.
the Alexis is capable for murder but the Petros not is capable
 ‘Alexis is capable of murder, but Petros is not capable.’

- b. O Alexis ine perifanos ja ton jo tu, ala o Petros dhen ine
the Alexis is proud of the son his but the Petros not is
 perifanos.
proud
 ‘Alexis is proud of his son, but Petros is not proud.’

There is overwhelming evidence (Alexiadou & Anagnostopoulou 1998, Alexiadou et al. 2015) that verbal roots in Greek (which I will represent as V for simplicity’s sake) raise to T (or to some head that c-commands vP, at least), and that even participial verbs in the perfect raise to a higher, vP-external position. Classic evidence for this verb movement comes from the relative position of subject-oriented adverbials between the verb and its direct object (PP indicates the perfect participle, which does not agree with any argument):

- (7) a. Itan safes oti to pedhi ekapse epitidhes ti supa.
it.was clear that the child burned.3s intentionally the soup.ACC
 ‘It was clear that the child burned the soup intentionally.’
- b. Itan safes oti to pedhi ixē idhi kapsi epitidhes ti
it.was clear that the child had.3s already burned.PP intentionally the
 supa.
soup.ACC
 ‘It was clear that the child had already intentionally burned the soup.’

Bowers’ Pred has been variously redubbed Voice or v when it is used in the verbal extended projection: it is the head that introduces the external argument. As Bowers points out, Pred is cross-categorical, given that nouns, adjectives, and prepositions can take subjects as well. For reasons of perspicuity and consistency with much recent literature (including Merchant 2013c and Alexiadou et al. 2015), I will use v as the label for Pred when Pred takes a VP as its sister, but I stress that this is merely a notational convenience. (In any case, the reader should bear in mind that this v is the argument-introducing one; some work takes v to be a categorizing node, a function I would attribute to a V node combining with an uncategorized root if this were salient.) This means that the structure of the embedded clause in (7a) will be that given in (8); again, because the details of head movement are not relevant to our concerns, I will follow Bennett et al. (2017) in representing the result of head movement simply as a vertical stack of labels, and I will omit additional functional material that associates with verbs in particular, such as Voice and Aspect (see Merchant 2015 and Spyropoulos et al. 2015 for exploration of these details in Greek).

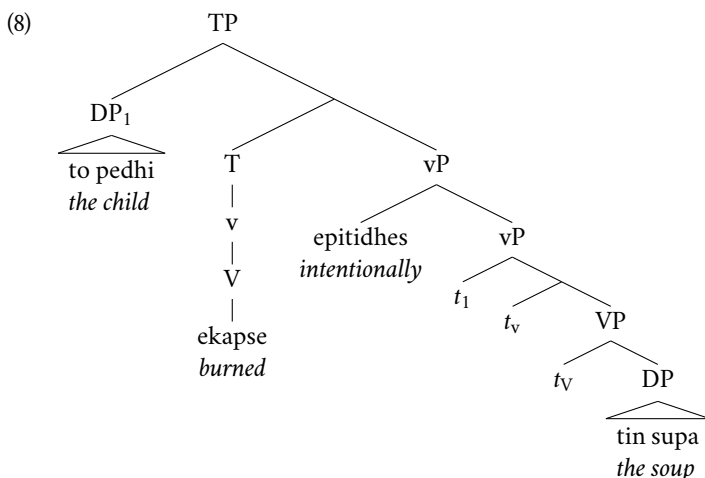

The finite verb can invert with the subject in questions and relative clauses (and even in simple declaratives under certain discourse conditions); if such inversions must be fed by movement of the verb to T, then their presence in Greek is a further argument for V-to-T movement.

3 VERB-STRANDING ELLIPSIS

We have concluded that Greek is a language with predicate (PredP/vP) ellipsis and with V-(to-v-)T movement. The question, then, is whether these two things can be combined. The combination of the movement of a head H with ellipsis of HP (or of an XP contained HP, if H moves out of XP) has been the focus of a large literature (see Funakoshi 2012, Lipták & Saab 2014, Gribanova & Mikkelsen 2018, Manetta 2018, and Sailor To appear for recent approaches), in particular with respect to the movement of verbs out of elided verb phrases. The primary analytical issue revolves around examples like the response in (9) and the second clauses in (10)-(11).

- (9) Question: Agorases psomi? Answer: Ne, agorasa.
bought.2s bread yes bought.1s
 ‘Did you buy bread?’ ‘Yes, I did. (buy bread)’
- (10) Epidhi i Anna ithele na agorasi psomi, agorase.
because the Anna wanted SUBJ buy.3s bread bought.3s
 ‘Because Anna wanted to buy bread, she did. (buy bread)’
- (11) Prota irthe ena agori pu agorase psomi. Meta irthe ena koritsi pu
First came a boy who bought bread then came a girl who
episis ithele na agorasi.
also wanted SUBJ buy.3s
 ‘First a boy came who bought bread. Then a girl came who also wanted to. (buy)’

Examples like these have been the object of sustained and insightful investigation in Irish in a series of works by Jim McCloskey (McCloskey 1991, 1996, 2017, Bennett et al. 2017), who has shown beyond a doubt that the finite verb in an Irish example such as (12) raises to a position outside the target of ellipsis (in his recent work, the verb moves to Pol, above a lower TP, which can elide).

- (12) Gabh ar mo dhroim anseo. Chuaigh.
go.IMPERV on my back here go.PAST
 ‘Get up here on my back. He did.’ (McCloskey 2017:23 (54d))

A number of researchers, building on McCloskey’s seminal work, have expanded this line of analysis in a number of other languages (see Goldberg 2005, Gribanova 2013b, 2013a, 2017a, 2017b, 2017c, for extensive discussion and references).

For a Greek example like (9), then, the combination of verb movement and vP ellipsis is represented as follows.² The diagram in (13a) gives the antecedent clause, and (13b) gives the clause hosting the ellipsis. The ellipsis is licensed by an E-feature on T, which triggers the non-pronunciation of the struck-through boxed vP (each terminal node in the elided vP is marked as not being subject to Vocabulary Insertion; see Saab 2009, 2016 for details). The calculation of identity of meaning, modulo focus-marking (Merchant 2001) is also successful (a similar result would be achieved if syntactic identity were taken as criterial, in whole or in part, whether entailed or implied; see Chung 2000, 2013, Chung et al. 2010, Merchant 2013c).

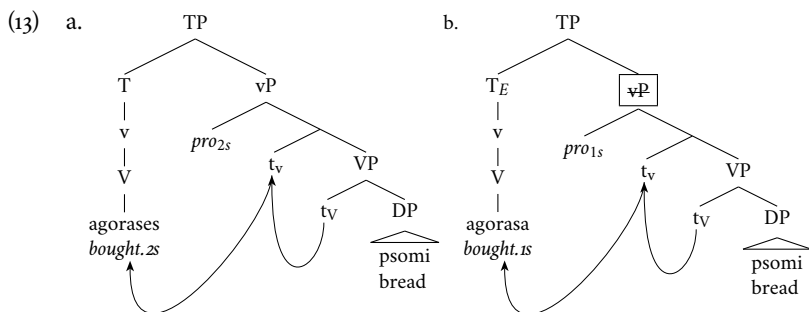

The primary analytical challenge in coming to a secure understanding of these structures is excluding alternative possibilities. We must be sure that there are no independently available mechanisms in the grammars of the relevant languages that would give rise to equivalent structures and meanings. In practice, this means we must closely investigate the other possibilities for omitting understood arguments, and ensure that those mechanisms cannot generate the structures in question.

²Greek is a pronominal subject-drop language, which I represent here for convenience with an in situ *pro*; as Alexiadou & Anagnostopoulou (1998) persuasively argue, there is no reason to believe that Greek has an EPP requiring a filled specifier of TP.

4 ARGUMENT OMISSION?

Greek is not at all unusual in having verbal and predicate alternations that appear to be due to the optionality of certain arguments. This alternation, when it affects definite pronominal subjects, is generally known as *pro*-drop, and, generalizing, when it affects arguments of any kind, as argument drop.

The differences between dropped pronouns, with definite anaphoric reference, and dropped indefinite arguments, can be seen in the following example, from Giannakidou & Merchant (1997).

- (14) a. Q: Irthan {deka/kapji/meriki} fitites?
came.3p ten/some/several students
 'Did ten/some/several students come?'
 b. A: Ne, irthan.
yes came.3p
 'Yes, {ten/some/several} students came.' or 'Yes, they came.'

As indicated in the translations, the Greek answer is compatible with two intended readings: either the answerer intends to refer to the individuals in the set of students introduced in the question (the definite anaphoric reading, compatible with a specific reading of the indefinite), or the answerer intends merely to affirm that a certain set with the given cardinality came, without being willing or perhaps able to specify who the members of that set in the actual world might be. Notice that the English pronoun *they* in this context lacks the second reading. This is evidence that Greek argument drop, including of subjects, does not always involve traditional *pro*-drop. (As Giannakidou & Merchant (1997) claimed, there are several ways to get to a null DP, including combining a null indefinite determiner with NP-ellipsis.)

Bare singulars, both mass and count, can also go missing, as in B's responses to A's questions in (15) and (16):

- (15) a. A: Agorases efimeridha?
bought.2s newspaper
 'Did you buy a newspaper?'
 b. B: Oxi, dhen ixē. Dhen boresa na vro.
no not had.3s not could.1sg SUBJ find.1s
 'No, there weren't any. I couldn't find one.'
- (16) a. A: Agorases zaxari?
bought.2s sugar
 'Did you buy sugar?'
 b. B: Oxi, dhen ixē. Dhen boresa na vro.
no not had.3s not could.1sg SUBJ find.1s
 'No, there wasn't any. I couldn't find any.'

Count singulars with the indefinite article and bare plurals also license omission:

- (17) Agorasa ena sfungari jati mu ipes na fero (ena).
bought.is a/one sponge because me told.2s SUBJ bring.is one
 ‘I bought a sponge because you told me to bring one.’
- (18) Agorasa sfungaria jati mu ipes na fero.
bought.is sponges because me told.2s SUBJ bring.is
 ‘I bought sponges because you told me to bring some.’

But such indefinites do not license omission if they are the objects of prepositions:

- (19) a. M’aresi n’agoraso efimeridha to proi—panda matheno ta panda apo
 *(efimerida).
 b. *Dhen tro zaxari jati ime alergiki se.
 c. Idhame vivlia, ala dhen milisame ja *(vivlia).
 d. Ta pedhia piran apo ena vivlio, epidhi i gonis plirosan apo
the children got from one book because the parents paid.for from
 *(ena).
one
 ‘The children each got a book because the parents each paid for (one).’

When the antecedent is definite, however, whether on a type or token use, this kind of omission is not possible; this is true both inside and outside of islands:

- (20) A: Agorases to vivlio?
bought.2s the book
 ‘Did you buy the book?’
- B: Oxi, dhen *(to) ixan. Dhen boresa na *(to) vro puthena.
no not it had.3p not could.is SUBJ it find.is anywhere
 ‘No, they didn’t have it. I couldn’t find it anywhere.’
- (21) a. Dhen agorasa to vivlio jati dhen boresa na *(to) vro
not bought.is the book because not could.is SUBJ it find.is
 puthena.
anywhere
 ‘I didn’t buy the book because I couldn’t find it anywhere.’
 b. Dhen agorasa to vivlio ala gnorisa tin jineka pu *(to) egrapse.
not bought.is the book but met.is the woman that it wrote.3s
 ‘I didn’t buy the book, but I met the woman who wrote it.’

In this respect, this kind of definite pronominal argument omission is very different from the situation in Hebrew or Russian, both of which permit definite objects to be dropped when the verb whose argument they are is not inside an island (Gribanova 2013b). Hebrew also allows this kind of argument omission inside islands, as Landau (2017) documents.

The empirical pattern, then, is somewhat complex. In all the above cases, the verb whose argument is omitted is not that same as the verb that introduces the antecedent argument. These examples are chosen in order to help minimize the possibility that these examples involve a kind of VSE. But as we will see below, it is not an absolute requirement that the verbs match: instead, contrastive focus can allow for mismatched verbs. Absent such focus, however, it seems that Greek has limited ability to license null arguments when the antecedent is a full DP (whether definite or indefinite). This is particularly clear in the distributive prepositional case in (19): if arguments could be freely omitted (assuming they have the appropriate kind of antecedent, as would be the case in (19)), the fact that (19) is unacceptable without an overt DP complement to the preposition *apo* would be unexplained.

This is not to imply that Greek lacks predicates that allow for implicit arguments. It does possess such predicates, and it is important to examine such cases carefully to distinguish them from VSE.

4.1 IMPLICIT ARGUMENTS

To ensure that the cases of verb-stranding ellipsis above do not involve mere argument drop, it is important to fully delimit the range of possible implicit arguments. A complete typology must include missing selected DPs, PPs, and CPs of various types. Beyond the often noted indefinite (existential) implicit arguments, there are definite ones, reflexive ones, and reciprocal ones. I illustrate first with English, before turning to the Greek cases.

- (22) Implicit indefinite arguments (Fodor & Fodor 1980, Dowty 1981, Mittwoch 1982)
- a. John {baked / ate / hunted / read / served the guests}.
 - b. John {baked a cake / ate a carrot / hunted a rabbit / read a book / served the guests the salad}.
- (23) Implicit definite arguments (Fillmore 1986)
- a. Susan {noticed / understood / saw}.
 - b. Susan {noticed / understood / saw} the error / that something was wrong.
- (24) Implicit reflexive arguments
- a. Maxwell {shaved / bathed / scratched}.
 - b. Maxwell {shaved / bathed / scratched} himself.
- (25) Implicit reciprocal arguments
- a. Adam and Beth {kissed / screwed / divorced}.
 - b. Adam and Beth {kissed / screwed / divorced} each other.

It is striking to note that all of these kinds of implicit arguments can be found with predicates which, when they take these arguments overtly, mark them obligatorily with lexically selected prepositions.³ This observation, to my knowledge, has not been made previously in the literature, and indicates that any system that merely suppresses DPs (or NPs) in these positions, or which posits null DPs, does not generalize to the full range of facts.

- (26) John {flirted (with someone) / was shooting (at something) / argued (with someone)}.
- (27) Susan {agreed (to it / with it / us) / looked (at it)}.
- (28) Maxwell is proud (of himself).⁴
- (29) Adam and Beth {are married (to each other) / broke up / argued (with each other)}.

Not all predicates allow for implicit arguments. Even predicates that have very similar meanings to those that license implicit arguments do not themselves always license such arguments. It is not predictable from the meaning of the predicate whether it will allow for an implicit argument, as the following sets of near minimal pairs with the above show.

- (30) John ingested / devoured / created / overcooked *(something).
- (31) Susan noted / comprehended / realized *(something / that something was wrong).
- (32) Maxwell combed *(himself / his hair).
- (33) Adam and Beth despise *(each other).

The literature on implicit arguments highlights three properties to be captured by any analysis of implicit arguments:

- (34) a. implicit arguments are lexically dependent (some predicates license them, others don't)
- b. implicit arguments don't occur as subjects or objects of transitive prepositions
- c. implicit indefinite arguments always take narrowest possible scope

The first and second properties point to a lexical operation on predicates, or an encoding of syntactic optionality in the lexical entry. One formalization of the selectional features of predicates like *eat* and *ingest* is given below, where the selectional features form a list (an ordered n-tuple) whose elements must be satisfied in the order given:

³Chung (2006) discusses implicit PPs which are understood as existentials, as in (26).

⁴In such cases, the simple adjective seems to have a characterizing, individual-level meaning, while the adjective with a PP can have a stage-level meaning as well.

- (35) a. $eat \left[\begin{array}{l} \text{CAT} \\ \text{SEL} \end{array} \left[\begin{array}{l} [V, -AUX] \\ [< (D) >] \end{array} \right] \right]$
 b. $ingest \left[\begin{array}{l} \text{CAT} \\ \text{SEL} \end{array} \left[\begin{array}{l} [V, -AUX] \\ [< D >] \end{array} \right] \right]$

The crucial device is the parenthesis, following Chomsky (1965), to collapse two otherwise equivalent lexical entries. This device is employed in more familiar representations of lexical entries in Levin & Rappaport (1988), Sadock (1991), Pollard & Sag (1994), Bresnan (2001), and Culicover & Jackendoff (2005).

Work on existential implicit arguments of predicates such as *eat* and *read* handle the restriction to narrowest scope in a variety of ways. Fodor & Fodor (1980) use meaning postulate like that in (36), while Dowty (1981) posits the lexical rule in (37).

- (36) $x \text{ read}_i \text{ iff } \exists y \ x \text{ read}_t \ y$

- (37) DETRANSITIVIZATION

If $\alpha \in P_{TV}$, then $F(\alpha) \in P_{IV}$ (where $F(\alpha) = \alpha$).

TRANSLATION RULE:

$\lambda x \exists y [\alpha' (P[P_y])(x)]$

However, as the most comprehensive account of the full range of implicit arguments, Gillon (2012), shows, such accounts are inferior to one that uses specific VP-interpretation rules that depend on the presence of diacritics on the particular predicates (for existential, definite, reflexive, and reciprocal interpretations), as in (38):

- (38) Let D be the domain of the model and let G be the set of ordered pairs, or graph, of the binary relation assigned to a lexical entry with the argument frame of $\langle \underline{NP}; NP, q \rangle$. Then, the function assigned to q assigns $\{x : \exists y \in D \text{ and } \langle x, y \rangle \in G\}$ to the VP node of the V node dominating the lexical entry.

This approach extends straightforwardly to the cases of implicit PPs as well.

Greek also has predicates in the first two of these classes as well: existential and definite (the latter may be partially identified under 'Null Complement Anaphora', if these differ in fact). Reflexive and reciprocal implicit arguments trigger obligatory use of the nonactive form of the verb, and so no simple argument drop is possible with these classes (see Alexiadou et al. 2015).

- (39) I Ariadne majirepse / efage / dhiavase / paleve / flertare.
the Ariadne cooked ate read fought flirted
 'Ariadne cooked / ate / read / fought / flirted.'

- (40) I Ana ikserē / idhe / katalave.
the Anna knew saw understood
 ‘Anna knew / saw / understood.’

Note that such uses of these predicates is not restricted to non-island or non-embedded contexts; they are perfectly acceptable inside islands:

- (41) An majirevi i Ariadne, oli tha xaromaste.
if cooks the Ariadne all FUT be.glad.1p
 ‘If Ariadne is cooking, we will all be glad.’
- (42) I astinomia milise me kathe pliroforiodhoti pu idhe / ikserē.
the police spoke with every informant who saw knew
 ‘The police spoke with every informant who {saw it/knew}.’

There are numerous predicates that take obligatory internal DP or selected PP arguments (in English, the latter include *rely on*, *wallow in*, *depend on*, *consist of*).

- (43) a. Mikra mora? Dhen filao *(mikra mora) pote!
small babies not kiss.is small babies ever
 ‘Little babies? I never kiss little babies!’
- b. Oson afora tin prostasia tis ergasias, to ikonomiko modelo
as.far.as concerns the protection of.the labor the economic model
*stirizete *(s’aftin).*
depends on.it
 ‘As far as protection of labor is concerned, the economic model depends on it.’
- c. Oson afora tin erotisi dio, o dhaskalos epimēni *(s’aftin).
as.far.as concerns the question two the teacher insists on.it
 ‘As for question two, the teacher insists on it.’

Such predicates that take obligatorily expressed internal arguments, whether DP or PP, make up a crucial first testing ground for VSE: if such predicates occur without their expected DP or PP sisters when the predicate head has an antecedent, but not otherwise (as just demonstrated in (43)), we are licensed to conclude that something else is at work. That something else is VSE.

This prediction is borne out. We see in (44) that the object can be missing but understood just in case there is an antecedent VP headed by the identical verb:

- (44) a. A: Filas mikra mora?
kiss.2s small babies
 ‘Do you kiss small babies?’
- b. B: Dhen filao pote!
not kiss.is ever
 ‘I never do!’ (lit. ‘I never kiss!’)

This pattern is replicated with verbs that take obligatory PP arguments. In (45a-c), we see the verb *stirizome* ‘depend’ without its obligatory PP complement. In all cases, the verb has an antecedent that heads a VP with the requisite PP. (46) shows the same for the verb *epimeno* ‘insist’.

- (45) a. A: *Stirizete katholu to ikonomiko model stin prostasia tis*
depends at.all the economic model on.the protection of.the
ergasias?
labor
 ‘Does the economic model depend at all on the protection of labor?’
 B: Ne, *stirizete.*
yes depends
 ‘Yes, it does.’
- b. *To politiko modelo stirizete stin prostasia tis ergasias —*
the political model depends on.the protection of.the labor
dhistixos, to ikonomiko modelo dhen stirizete.
unfortunately the economic model not depends
 ‘The political model depends on the protection of labor — unfortunately, the economic model does not.’
- c. *To oti dhio stus tris neus stirizunte stus gonis tus simeni*
the that two on.the three young depend on.the parents their means
oti enas stus tris dhen stirizete.
that one on.the three not depends
 ‘The fact that one out of three young people depend on their parents means that one out of three does not.’
- (46) *Parolo pu o dhaskalos epemine stin erotisi dio, o voithos dhen*
despite that the teacher insisted on.the question two the aide not
epemine.
insisted
 ‘Although the teacher insisted on question two, the aide didn’t.’

Another kind of obligatory argument is the definite pronoun in a context that supports one. These pronouns are proclitic on the finite verb in Greek, making examples with verbs and clitic objects useless for testing for VSE, since both the verb and its object will have raised out of the putatively elided vP:

- (47) a. A: *Idhes tin tenia?*
saw.2s the movie
 ‘Did you see the movie?’
- b. B: Ne, *(tin) *idha.*
yes it saw.1s
 ‘Yes, I did.’ or ‘Yes, I saw it.’

The only exception to this pattern is found with certain verb+noun idioms, where the object of the combined verb+noun can be a full DP or a pronoun, but when

the verb is used in VSE, both the noun part of the idiom and any potentially pronominal object must be elided.

- (48) A: Pires *prefa tin katastasi?*
took.2s prefa the situation
 'Did you get wind of the situation?'⁵
 B: a. Pira.
 b. *Tin pira.
 c. (Tin) pira *prefa.*
it took.1s prefa
 'I did/I got wind of it.'

- (49) A: Pires *xabari tin kopela?*
took.2s notice the girl
 'Were you aware of the girl?'
 B: a. Dhen pira.
 b. *Dhen tin pira.
 c. Dhen (tin) pira *xabari.*
not her took.1s notice
 'I was/I was aware of her.'

What is unusual about these idioms, and sets them apart from regular transitive verbs like (47) above, is that they also allow for a dropped object without any ellipsis, as seen in the (c) examples. It is the possibility of this pronoun-less alternant that gives rise to pronoun-less VSE in the (a) examples. (Why precisely the otherwise expected, and indeed possible, definite pronoun is omissible just with these idioms, I leave for future work, but the solution seems orthogonal to questions about ellipsis.)

4.1.1 NPI, DISJUNCTIVE, GENERIC, QUANTIFICATIONAL, AND IDIOM CHUNK ARGUMENTS

Gribanova (2013a,b) argues persuasively that Russian has VSE, partly on the basis of a series of well-constructed examples that involve objects that cannot be easily anaphorized, and therefore are poor candidates for pronominal 'object-drop' or some other process of object omission (which Russian has). These involve five kinds of objects: negative polarity items (NPIs), disjunctions, bare singular generic nouns, weak quantificational noun phrases, and certain idiom chunks.

Each of these DPs fails to provide a licit antecedent to a pronoun or, in the case of weak quantifiers and disjunctions, gives rise to a different meaning. Therefore, if we find examples that involve a verb whose object is one of these DPs, we can be sure that the missing DP is not a definite pronoun that has somehow been omitted (as we have seen, Greek lacks a general process of object drop in any case).

⁵*Prefa* is the Greek name of the Russian card game *Preferans*, though many Greeks may know neither the game nor the word outside of this idiom. Cf. *cahoots* in the idiom *be in cahoots with* in English.

Very briefly, I give the results of attempting VSE with each of these kinds of objects, and contrast the licit VSE with illicit pronouns.

The first case comes from NPIs headed by the n-word determiner *kanenas* (see Giannakidou (2000)). As can be seen below, both negative and positive responses are possible (see Merchant (2013b) for discussion of this alternation, which is found in English as well). Responses with a definite pronoun are anomalous: the NPI does not introduce a referent into the discourse context that the pronoun could pick up on.

- (50) Dhen vrikes kanena meros ja na parkaris to amaksi?
not found.you any spot for SUBJ park.2s the car
 ‘Didn’t you find any spot to park the car?’
- (51) a. Oxi, dhen vrika.
no not found.I
 ‘No, I didn’t (find any spot to park the car).’
 b. Ne, vrika.
yes found.I
 ‘Yes, I did (find a spot to park the car).’
- (52) a. #Ne, to vrika.
yes it found.I
 #‘Yes, I found it.’
 b. #Oxi, dhen to vrika.
no not found.I
 #‘No, I didn’t find it.’

Disjunctions deliver a parallel set of facts. A definite pronoun would give rise to an unwanted existential presupposition in the following example, but the VSE variant is well-formed.

- (53) a. Paratirises i kena i lathi sto xirografo?
observed.2s either gaps or errors in.the manuscript
 ‘Did you observe either lacunae or errors in the manuscript?’
 b. Oxi, dhen (#ta) paratirisa.
no not them observed.is
 ‘No, I did not.’

Bare singular noun phrases can have generic meanings (or, in some circumstances, singular indefinite nonspecific existential readings). These generic readings do not license following pronouns, but they do participate in VSE:

- (54) a. Foras kaskol?
wear.2s scarf
 ‘Are you wearing a scarf?’ or ‘Do you wear scarves?’
 b. Ne, (*to) forao.
yes it wear.is
 ‘Yes, I am.’ or ‘Yes, I do.’

Quantificational noun phrases can license pronominal anaphora, of course. But VSE, like VPE in English, gives rise to a second quantificational set, as seen in the following example:

(55) a. Example from Giannakidou & Merchant (1997) (1):

Efere	o	Andreas	merika	vivlia?
<i>brought._{3s}</i>	<i>the</i>	<i>Andreas</i>	<i>several</i>	<i>books</i>
			<i>kapja</i>	
			<i>some</i>	
			<i>liga</i>	
			<i>a.few</i>	
			<i>dheka</i>	
			<i>ten</i>	
			<i>tulaxiston tria</i>	
			<i>at.least three</i>	
			<i>parapano apo tria</i>	
			<i>more than three</i>	
			<i>tipota</i>	
			<i>any</i>	
			\emptyset	
			\emptyset	

‘Did Andreas bring {several/some/a few/at least three/more than three/any/ \emptyset } books?’

b. Ne, (%ta) efere.

yes them brought._{3s}

‘Yes, he brought {several/some/a few/at least three/more than three/any/ \emptyset } books’ ≠ ‘Yes, he brought them.’

As can be seen from the two translations in (55b), there are two possible readings to the Greek. In the first, the anaphoric reading, the neuter plural definite anaphoric pronoun *ta* refers to the set of books introduced in the question; this reading is possible only if the indefinites can be read with specific reference, that is, with the first six of the collapsed examples, and not with the last two (no specific readings are possible with *tipota* ‘any’ or the bare plural): the ‘%’ diacritic means that *ta* is licit with these first six antecedents, and not with the last two. In the second possible reading, when the *ta* is omitted, we have a quantificational reading: the indefinite inside the ellipsis site is understood with its own quantificational force, and there is no commitment on the part of the answerer to the set they answer about to be extensionally identical to any set the questioner may have had in mind—only the cardinality is at stake.

Finally, there are many VP idioms that consist of a verb with its object and which do not allow an anaphoric pronoun (since there is nothing to be anaphoric to, on the idiomatic reading). Nevertheless, such idioms allow their object to be omitted;⁶ the inclusion of the pronoun makes the literal reading (*eating wood* in

⁶The judgments here are somewhat variable across speakers, with some speakers finding all of

(56), for example) the only one available, to some amusement of my Greek consultants).

- (56) a. To pedhi tha fai ksilo, ke o Kostas episis tha (#to) fai ki aftos!
the kid FUT eats wood and the Kostas also FUT it eats and he
 ‘The kid will get hit, and Kostas will, too!’
- b. To pedhi tha fai ksilo, ala o Kostas dhen tha (#to) fai.
the kid FUT eats wood but the Kostas not FUT it eats
 ‘The kid will get hit, but Kostas won’t.’

The following examples further illustrate the same point, using a wider variety of Greek VP idioms.

- (57) O Dimitris kani tin papia; mono i Ariadne dhen (#tin) kani.
the Dimitris makes the duck only the Ariadne not it makes
 ‘Dimitris is playing dumb; only Ariadne isn’t.’
- (58) a. O Petros efige ke erikse mavri petra piso tu.
the Petros left and threw black stones behind him
 ‘Petros left and will never return.’
- b. Ke i Maria erikse.
and the Maria threw
 ‘And Maria also will never go back.’
- (59) I Elines politiki tazun lagus me petraxilia, ala i Amerikani
the Greek politicians vow rabbits with priests’ habits but the American
politiki pote dhen tazun.
politicians never not vow
 ‘Greek politicians promise the moon, but American politicians never do.’
- (60) O nearos ekane kamaki se mia jineka. Afti tu ipe na figi. Otan
the young man made advance to a woman she him told to leave when
ksanaekane, ton evrise.
again.made him cursed
 ‘The young man hit on a woman. She told him to leave. When he hit on her again, she yelled at him.’
- (61) O Janis ke i Maria ithelan na dhosun logo, ala i gonis tus
the Giannis and the Maria wanted to give.3pl word but the parents theirs
dhen ithelan na dhosun.
not wanted to give.3p
 ‘Giannis and Maria wanted to get engaged, but their parents didn’t want them to.’

Finally, Greek has particle-verb-like combinations that involve a light verb and an adverbial particle. These may not be entirely like idioms, since their meanings may be computable from the regular contributions of the pieces, but their

these permit the idiomatic readings, and some more conservative, who accept only a literal reading.

behavior is not easily explicable if Greek lacks VSE. One such is *perno piso*, literally ‘take back’, meaning *take back* or *get back*. As indicated in (62), this particle can occur anywhere in the clause, even preverbally, though there its placement is presumably due to focus movement, and it cannot be used out-of-the-blue (and which I omit for that reason). This verb+particle combination appears with a direct object and a source PP.

- (62) *Pire* {piso} *i Ana* {piso} *xrimata* {piso} *apo tin trapeza* {piso}?
took.3s back the Ana back money back from the bank back
 ‘Did Anna get money back from the bank?’

The question in (62) can be answered as follows:

- (63) *Ne, pire* (*piso).
yes took.3s back
 ‘Yes, she did. (get money back from the bank)’

Note that VSE is licit with just the verb remaining. The particle does not, and cannot, survive VSE.⁷ This is entirely expected if the verb has moved to T, and if the arguments and particle must remain inside the boxed elided VP:

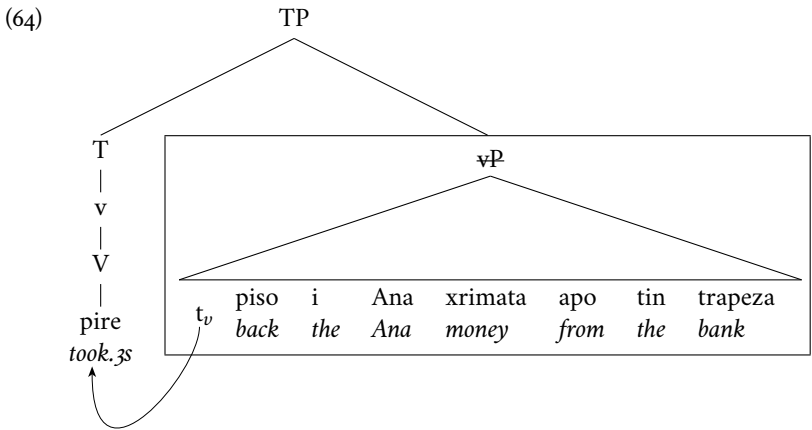

All of these data indicate that Greek is not merely dropping pronominal or indefinite arguments; the data are only consistent with a derivation by VSE.

4.1.2 WHAT IS THE TARGET OF ELLIPSIS?

If VSE requires verb movement to vacate a verbal projection targeted by ellipsis, we can justifiably ask, what precisely is being elided? Is there evidence that the verb must move at least that much? If the verb can be shown to be in situ, no VSE analysis should be possible.

⁷In this Greek contrasts with Hungarian, which allows such phrasal ‘verbal modifiers’ to strand, as Lipták (2012) shows.

Landau (2017) argues that in Hebrew, there are object gap examples where the verb stays in situ, and which therefore cannot be due to VSE (but rather are due to argument ellipsis). His evidence that the verb remains in its base position comes from the fact that the verb can occur to the right of the lowest adverbial on Cinque’s hierarchy, namely the frequentative *often*, and co-occur with completive *completely*. Landau takes this to mean that the verb has not raised to T, but rather has stayed in situ; such a position would rule out a VSE analysis, and yet sloppy identity in the missing object can still be understood.

Such examples can be produced in Greek as well (modeled on Landau 2017 (34b)):

- (65) O Nikos mia fora ksirise to kefali tu en meri afu akuse oti o
the Nikos one time shaved the head his in part because heard.3s that the
 Petros sixna ksirizi endelos.
Petros often shaves completely
 ‘Nikos once shaved his head partially because he had heard that Petros
 often shaves his head completely.’

A similar point can be made on the basis of low participles. Such participles do not move to T (the finite auxiliary verb does), and if such movement were required to license VSE, then these examples would show that VSE is not available.

- (66) To agori exi fai ksilo; to koritsi dhen exi fai.
the boy has eaten wood the girl not has eaten
 ‘The boy got smacked; the girl didn’t.’
- (67) a. Tin exo grameni sta palia mu ta paputsia.
her I.have written on.the old my the shoes
 ‘I won’t have anything to do with her.’
- b. Ki ego tin exo!
and I her have
 ‘I won’t either!’

Fortunately for the argument in favor of the existence of VSE in Greek, there is reason to believe that even participles move out of their vP. As seen above in (7ab), repeated here, participles can appear to the left of relatively ‘high’ adverbs, such as *epitidhes* ‘intentionally’ (see Alexiadou 1997).

- (68) Itan safes oti to pedhi ixē idhi kapsi epitidhes ti
it.was clear that the child had.3s already burned.PARTICIPLE intentionally the
 supa.
soup.ACC
 ‘It was clear that the child had already intentionally burned the soup.’

The evidence from the placement of adverbs in (65) rests on a supposition that adverbs like *often* cannot be adjoined higher in the extended projection of the VP, which I know of no reason to believe is true in Greek.

We can conclude that if the verb raises to at least the lowest Aspect head, then ellipsis could target VoiceP or vP beneath Aspect.

4.2 EXTRACTION

As discussed in Merchant (2013a, 2016), one of the most important and persuasive diagnostics for ellipsis of syntactic material comes from movement dependencies (see especially the seminal discussion in Hankamer & Sag 1976 and Sag & Hankamer 1984). Selection is local to particular heads. Thus, when we observe a selectional relationship that appears to hold between a displaced phrase and something inside an ellipsis site, we conclude that the ellipsis site contains a head with the relevant selectional ability or feature. In this respect, ellipses such as VP-ellipsis in English differ from otherwise interpretationally similar constructions such as Null Complement Anaphora.

VP-ellipsis after *to* allows for the extraction of the object of the missing verb:

(69) **VP-ellipsis:**

- a. We need to know which films Anna refused to review, and which ones she agreed to.
- b. We need to know which films Anna agreed to review, and which ones she refused to.

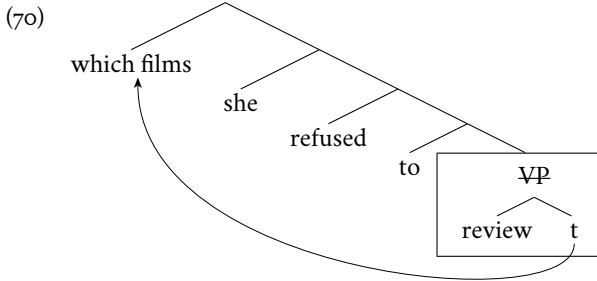

The same verbs, when used in their Null Complement Anaphora guises, fail to license the extraction of the object of an understood complement predicate:

(71) **Null Complement Anaphora:**

- a. We asked Anna to review these five films, and she agreed. (*sc.* to review them)
- b. *We need to know which films Anna refused to review, and which ones she agreed.

This has a straightforward interpretation if Null Complement Anaphora involves a suppression of a selectional feature and thus the absence in the syntactic representation of any complement at all. In its use in (71), then, the verb *agree* is syntactically intransitive: its only syntactically projected argument is its subject. Although the meaning is computable as a relation between the denotation of the subject and a set of events of reviewing films, the process for this computation takes place without the aid of syntactic structure meaning ‘review these five films’ that is local to *agree*.

We therefore conclude that there is active syntactic structure (licensing extraction, agreement, and other syntactically mediated dependencies) inside ellipsis sites. There is no evidence for such structure inside the understood argument in Null Complement Anaphora. By Ockham's razor, we suppose that the simplest explanation of this fact is the absence of such structure.

The Greek case is similar, with the difference that verb-raising occurs before the ellipsis of the VP: movement of a verb out of an ellipsis site can be combined with movement of a phrase from within the elided phrase as well.

- (72) Thelo na miliso ja to proto thema. Ja to deftero, dhe thelo.
want.is SUBJ speak.is about the first topic about the second not want.is
 'I want to speak about the first topic. About the second one, I don't (want to speak).'

As in (4b) above, it is crucial that what is extracted in (72) is an I-selected PP, here *ja to deftero* 'about the second one'. The preposition *ja* 'for, about' is selected by the predicate *milao* 'speak': it is not in any conceivable way an argument of the matrix verb *thelo* 'want'. Yet it appears in the second clause, fronted. This is only consistent, given any restrictive theory of I-selection, with the PP having been, at some stage of the derivation, a complement to the head of *milao*. We can therefore securely conclude that the second clause contains a missing VP.

The same point is made by the following questions:

- (73) Me pjon ithele i Maria na milisi, ke me pjon ithele i Ana?
with whom wanted the Maria SUBJ speaks and with whom wanted the Ana
 <na milisi t>
 SUBJ speaks
 'With whom did Maria want to speak, and with whom did Anna?' <want to speak>

Here, the wh-phrase *me pjon* 'with whom' undergoes regular wh-movement to a clause-initial position, along with V-movement of the matrix verb *ithele* 'wanted', to T.

(74)

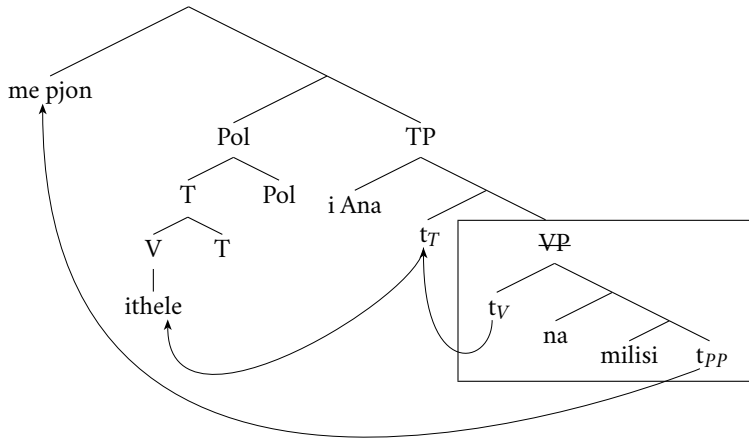

Similar remarks hold for the following examples, which demonstrate PP questions, PP relatives, case-marked left-dislocated topicalization, and selected PP left-dislocations:

- (75) Ja pjes tenies simfonise i Ana na grapsi kritiki, ke ja pjes
for which films agreed the Ana SUBJ writes review and for which
simfonise i Maria?
agreed the Maria
'Of which films did Anna agree to write a review, and of which ones did Maria?' <agree to write a review>
- (76) Aftes ine i tenies stis opies simfonise i Ana na kani kritiki ke
These are the films to.the which agreed the Anna SUBJ make review and
aftes ine i tenies stis opies simfonise i Maria (na kani).
those are the films to.the which agreed the Maria to make
'These are the films of which Anna agreed to write reviews, and those are the films of which Maria did.' <agree to write reviews>
- (77) Ton Pavlo, simfonise i Ana na ton antikatastisi. Ton Petro,
the Pavlos.ACC agreed the Ana SUBJ him replace.3s the Petros.ACC
simfonise i Maria.
agreed the Maria.
'Pavlos, Anna agreed to replace; Petros, Maria agreed to.'
- (78) Sto kratos, o neos dhen drepete na stirizete, ala stus gonis,
on.the state the young not is.ashamed to depend but on.the parents
drepete.
is.ashamed
'On the state, the young man is not ashamed to depend, but on his parents, he is.'

It is important to remember that care must be taken when designing such stimuli; for many years, extraction from VP-ellipsis sites in English was thought to be almost uniformly ungrammatical, except for antecedent-contained deletions. In fact, such extraction is very sensitive to additional parallelism requirements (see Schuyler 2001, Merchant 2008) and other factors that are poorly understood; this is illustrated by (79). Some of the factors that lead to degradation in English also give rise to similar effects in Greek. For example, though Greek allows extraction of genitive DP possessors from definite DPs (Horrocks & Stavrou 1987), such extraction is highly degraded in a VSE context:

- (79) ??[Tu Gianni]₁ dhiavasa [to vivlio t₁], ala tu Kosta dhen
the Giannis.GEN read.is the book but the Kosta.GEN not
 dhiavasa.
read.is
 'I read the book by Giannis, but I didn't read the book by Kosta.'

Compare the ill-formedness of the English as well (as noted for similar examples in Sag (1976)):

- (80) *By Giannis, I read the book, but by Kosta, I didn't.

On the other hand, extraction of PP from a bare singular indefinite object or an object headed by the n-word *kanenas*, *kamia* 'any' is licit, whether that object is overt, as in (81a) or inside a predicate ellipsis site, as in (81b).

- (81) [PP Apo ta pafsipona]₁ dhiegnose i jatros [eksartisi t₁]; [PP apo
from the painkillers diagnosed the doctor addiction from
 tin iroini]₂ ...
the heroin
 'To painkillers, the doctor diagnosed an addiction; to heroin ...'
 a. dhe dhiegnose [PP kamia ekartisi t₂].
not diagnosed.3s any addiction
 '... she didn't diagnose any addiction.'
 b. dhe dhiegnose Δ.
not diagnosed.3s
 '... she didn't (diagnose an addiction).'

In sum, it is impossible to reconcile the possibility for extraction as seen in Greek with the idea that what is missing is either not projected in the syntax at all (as in Null Complement Anaphora) or is some kind of unpronounced pronoun or null argument (even a structurally complex indefinite NP one, along the lines of Giannakidou & Merchant 1997). The lexical selectional idiosyncrasies of a verb or noun internal to the elided material cannot plausibly be recapitulated by a semantic or pragmatic mechanism. Theories that eschew such syntactic structure (such as Culicover & Jackendoff 2005 or Jacobson 2016) have no recourse to

l-selection except through the highly implausible suggestion that the purely semantic incorporation of the PP is mediated in some way by the matching preposition. To my knowledge, no working mechanism with these properties has been proposed, and in my estimation, doing so would mean making purely idiosyncratic, lexical selectional information available to the semantics. This move has the same prospects for success as making the height of the vowels in a verb stem available to the syntactic computation for consideration in triggering verb movement. The syntactic ontology consists of features that determine part of speech and selectional information, among other things; the semantic ontology contains things like entities, properties, eventualities, times, etc., but not nouns and verbs. Needing to conflate the two is the sign of a theory in distress.

4.2.1 SLOPPY IDENTITY IS NOT A TEST

Greek definite pronouns easily allow what in English are considered marginal, ‘paycheck’ uses. This is true even for nonreferential DP antecedents with bound pronouns inside them, with inalienably possessed nouns in expressions that require binding by the local subject. In other words, this holds even with DPs that require sloppy identity.

- (82) O Alexandros edhose ton kalitero tu eafto afu ton edhose kai o
the Alexandros gave the better his self because it gave and the
 Pavlos.
Pavlos
 ‘Alexandros did his best because Pavlos did.’
- (83) I Ana exase tin zoi tis afu tin exase kai i Maria.
the Ana lost the life her because it lost and the Maria
 ‘Ana lost her life because Maria did.’

Therefore, the presence of sloppy identity readings in putative VSE examples such as (58) above and (84) here, which is ambiguous between a strict and sloppy reading, cannot be reliably used to diagnose ellipsis per se. See also Merchant (2013a) for skepticism about the value of sloppy identity as a diagnostic.

- (84) O Pavlakis tha fai ksilo apo ton ksadherfo tu, ala o Aleksis dhen
the Pavlakis FUT eat.3s wood from the cousin his but the Aleksis not
 tha fai.
 FUT eat.3s
 ‘Pavlakis₁ will get hit by his₁ cousin, but Aleksis₂ won’t (get hit by his_{2/1} cousin).’

Note that the ability of pronouns to allow ‘sloppy identity’ readings (that is, to covary with different subjects) is found in English only in the highly restricted contexts of ‘paycheck’ pronouns. In examples parallel to (82) and (83), English speakers have great difficulty in allowing for a covarying reading. Even when the bound reading is possible, it is not possible to find a new binder, for reasons ill-understood at present.

- (85) a. Arnold lost his life in the war, but before he lost it, he had written a letter to his mother.
 b. Arnold lost his life in the war, and #Bernard lost it, too.

5 FOCUS ON THE VERB: A POINT OF CROSS-LINGUISTIC DIFFERENCE

5.1 DO THE VERBS HAVE TO BE IDENTICAL?

One of the best known claimed characteristics of VSE is dubbed in Goldberg (2005) the Verbal Identity Requirement (VIR): the stems of the antecedent V and the elided V must be identical. This requirement is carefully documented for Irish by McCloskey (2017); other languages have been claimed to have it as well, most prominently Hebrew. Recently, Gribanova (2017a) has shown that such a requirement does not hold for the otherwise similar VSE found in Russian, and Landau (2017) has shown that it does not hold in Hebrew, either (Landau goes further and argues that Hebrew lacks VSE altogether).

Gribanova (2017a) gives the following example (her (39)) to demonstrate that Russian verbs under VSE can in fact differ, at least when they are appropriately contrastive:

- (86) Našel li Paša knigu v biblioteke? Net, poterjal.
find.PST.SG.M Q Paša book.ACC in library.PREP No lose.PST.SG.M
 'Did Pasha find a book in the library? No, he lost one there.'

Precisely this pattern holds in Greek as well. An acceptable example such as (87) must in fact be produced with a heavy contrastive focus (realized as a rise-fall pitch contour; see Arvaniti et al. 2006) on the verb in the question. By adding this focus, the speaker is explicitly raising the possibility of other verbs being part of the true answer to the implicit polar question (as well as the sentence with the given verb being false). This, of course, is just the very nature of contrastive focus on any element in a question.

- (87) Vrike_F o Petros ena vivlio sti vivliothiki? Oxi, exase_F.
found.3s the Petros a book in.the library no lost.3s
 'Did Petros FIND a book in the library? No, he LOST one/it there.'

If this strong focus is absent, either as contrastive focus or as verum focus, as is the case in a neutral polar question such as (88), the response with VSE is ill-formed; in that case, an overt object is required:

- (88) Vrike o Petros ena vivlio sti vivliothiki? Oxi. Exase #(ena).
found.3s the Petros a book in.the library no lost.3s one
 'Did Petros find a book in the library? No, he lost one/it there.'

Data showing this result were already given in Giannakidou & Merchant (1997), though the conclusion drawn there was different. Mismatched verbs are possible as in the following example, where the questioner puts an implicit contrastive focus on the verb, seeing the addressee with bread and thinking that the addressee may have stolen it (as opposed to buying it or baking it):

- (89) a. Eklepsēs psomi?
stole.2s bread
 ‘Did you steal bread?’
 b. Oxi! Agorasa!
no bought.1s
 ‘No, I bought bread.’

The examples are judged perfect if the same speaker is responsible for both verbs, because in this case, the speaker can decide beforehand that the verbs will contrast, and mark them both accordingly:⁸

- (90) O Petros dhēn vRIKE_F ena vivlio sti vivliothiki — EXASE_F.
the Petros not found.3s a book in.the library lost.3s
 ‘Petros didn’t FIND a book in the library — he LOST one there.’

So what distinguishes Irish from Greek (and Russian, Portuguese, etc.)?

5.1.1 IS VERB MOVEMENT IS SPECIAL IN IRISH?

One possibility is that Greek verb movement should be analyzed as Gribanova (2017a) proposes to do for Russian verb movement: as a kind of (potentially) long syntactic movement, which leaves a regular trace that can be abstracted over for the purposes of the computation of elliptical identity, however stated. In Irish, on the other hand, Gribanova proposes, the nature of the operation that builds the Irish verb complex is different. The syntactic verb does not actually leave the VP; rather, a different mechanism (called amalgamation, as developed in Harizanov & Gribanova 2017) ensures that the phonological material associated with the verb root is pronounced *ex situ*, but there is no actual syntactic movement. This move distinguishes Irish verbs from the many other elements that are able to move out of ellipsis sites and generate appropriate alternatives. As is well known, A- and A’-movements out of ellipsis sites are licit as long as they give rise to parallel binding dependencies:

- (91) a. Abby tends [*t*_{Abby} to work too hard], and Ben does ~~tend~~ [~~*t*_{Ben} to work too hard~~], too.

⁸It is worth noting that the acceptable examples of verbs differing in VSE in Russian from their antecedent presented in Gribanova (2013b):119 (65)-(66) involve a single speaker, while the unacceptable Hebrew examples from Goldberg (2005) involve different speakers. Perhaps the requisite contrast focus is difficult to project back onto a previous utterance from which it was absent.

- b. We need to know how many people Abby thinks we should invite *t_{how many people}*, and how many Ben does ~~think we should invite~~ *t_{how many}*.

This follows on any theory of ellipsis resolution that allows for traces to be interpreted as variables, and under which the index of a bound variable does not matter for the purposes of this computation, such as the LF-identity theory of Sag (1976), the semantic identity theory of Merchant (2001), or many others.

Note that Gribanova's claim is not the same as claiming that all head movement is 'at' PF, or that head movement leaves no trace, as Messick & Thoms (2016) do, expanding on Lasnik's (2003) claim that A-movement leaves no trace. The idea that head movement leaves no trace was appealing as part of an account of the Warner facts (Warner 1985), along with the putative constraint in (92) proposed in Thoms (2015):

- (92) "A variable cannot provide an antecedent for ellipsis of a non-variable."
(Thoms 2015:187)

Unfortunately, (92) cannot be sustained in the face of examples like the following, involving head movement (V₂ in Dutch), A'-movement, and A-movement, respectively (and see the works cited for many more such examples).

- (93) [_{CP} Nu gaat [_{TP} zij *t_{nu}* *t_{gaat}*]], maar ik weet niet waarom. Dutch
now goes she but I know not why
'She's going now, but I don't know why.' (Merchant 2001:21)
a. ≠ *... waarom zij.
b. = ... waarom zij ~~nu~~ gaat.
- (94) a. The FBI knows which truck₄ they rented *t₄*, but figuring out from where ~~they rented it₄~~ has proven difficult. (Merchant 2001:206)
b. This is Washington, where everyone keeps track of who₁ *t₁* crossed whom₂ and when ~~they₁ crossed them₂~~. (Merchant 2001:202)
- (95) These facts should be carefully studied, but it's clear you haven't ~~carefully studied these facts~~. (Merchant 2013c)

This state of affairs is fortunate, given that any claim that A-movement fails to leave a trace or a copy would leave us in the lurch for understanding passive of intensional transitives, and reconstructed scope under modals, negation, and quantificational adverbs, all of which indicate that for semantic reasons, the DP behaves as though it were in its base position (see Erlewine (2014) for extensive discussion of the mechanisms of reconstruction):

- (96) a. A miracle would be needed/desired/wanted.
b. Several magical beasts were hoped/prayed/looked for by the children.
c. Raspberries were often/easily found in those days around the pond.

These kinds of predicates can license VP-ellipsis as well, in two relevant varieties. In the first, in (97), the A-moved antecedent DP of the passive is understood as taking narrow scope, inside the VP that hosts its origin site (see Bruening (2013) for a recent defense of the movement approach to the passive), and the VP-ellipsis involves an active verb. The VP-ellipsis is interpreted as though the indefinite were inside the elided VP, taking narrow scope with respect to the intensional verb, modal, negation, or adverb of quantification.

- (97) a. A miracle would be needed, and if you do ~~need a miracle~~ then God help you.
 b. Usually, raspberries were easily found on those hikes, but we didn't manage to ~~easily find raspberries~~ that particular day.

In the second variety of example showing that A-movement can reconstruct inside ellipsis sites, both the antecedent VP and the elided VP involve A-movement (here, passives, though similar examples can be generated with raising predicates and intensional adjectives):

- (98) a. A unicorn was hoped for, and a dragon was ~~hoped for~~, too.
 b. Raspberries were often/easily found, and strawberries were ~~often/easily found~~ as well.
 c. Raspberries will be easily found, and strawberries will ~~be easily found~~ as well.
 d. A helmet will usually be found in such a grave site, as will a shield ~~usually be found in such a grave site~~.
 e. A kore wasn't often stationed in such a temple; a kouros wasn't ~~often stationed in such a temple~~, either.
 f. A shield was never made from gold, nor was a sword ~~ever made from gold~~.

These examples are important for another reason as well. They clearly demonstrate that the theory of ellipsis proposed in Heim (1997) is wrong.

Heim assumes a theory of ellipsis resolution that has three ingredients:

- (99) 1. A constraint banning 'meaningless coindexing'
 2. Rooth's (1992) focus alternatives condition
 3. "the deleted VP and its antecedent must be made up of the same lexical material." (Heim 1997, p. 9) where all indexed simple variables count as the same (the condition "doesn't care about matters of indexing").

Heim shows that these conditions, properly applied, can account for a range of data from Kennedy (1994) and additional data that she adduces. But, as she admits, "There would be a problem if the subjects were maximally reconstructed" (Heim 1997:12). In her discussion of (100a) (her (31)), Heim points out that a fully

reconstructed subject, as in (100b), would violate the lexical identity condition. Instead, she proposes (100c) as the LF, with focus-marked second subject, *Mary*, having moved out of the VP and interpreted outside of the VP.

- (100) a. John called, and Mary did too.
 b. ___ PAST [VP John call], and ___ did [VP ~~Mary call~~] too
 c. John_x PAST [VP x call], and [[Mary_F]_y did [VP ~~y call~~]] too

Such a focus-marked subject satisfies the focus-condition, which states that the focus-marked element must be contained in a phrase that contrasts appropriately with another phrase. This condition is dubbed the ‘containment’ condition in Merchant (2001), where the details of Rooth’s proposal are spelled out. Here, I repeat Heim’s slight restatement of Rooth, given in (101):

- (101) A constituent ϕ contrasts appropriately with a constituent ψ iff
 (i) ϕ and ψ don’t overlap, and
 (ii) for all assignments g , the (regular) semantic value of ψ w.r.t. g is an element of the focus value of ϕ w.r.t. g .

The regular semantic value of the antecedent clause in (100) in Heim’s system is just *John called* (from *John_x PAST [VP x call]*). The focus value of the clause containing the ellipsis and the focus-marked binder of the variable inside the elided VP is computed from the LF *[[Mary_F]_y did [VP ~~y call~~]]* and is {that x called: $x \in D$ }. Since *John called* contains no variables, it is not sensitive to g , and since *John called* \in {that x called: $x \in D$ }, and doesn’t overlap with it, the containment condition is satisfied, and ellipsis is licit.

Heim was right that her system only works if DPs A-moved out of an elided VP do not have to reconstruct. But unfortunately for her system, and for recent attempts to revive it, the examples in (98) are precisely the kind of data that are impossible to accommodate. In (98), the subjects *must* be maximally (that is, both the restrictor and the quantificational determiner) reconstructed (or at any rate, reconstructed to a position inside the VP which is the target for ellipsis, which comes to the same thing for the purposes of the problem for Heim’s account). And so the examples show that Heim’s theory fails.

To see in detail why this is, consider first the LF of the passive of the intensional transitive in (98a):

- (102) ___ PAST was [VP hoped for [a unicorn_F]] and
 ___ PAST was [VP hoped for [a dragon_F]]

Employing the proposal for the semantics of the passive in Bruening (2013), and ignoring tense, we have:

- (103) $\exists x[\forall w \in W_{hope(x)} : \exists y[unicorn_w(y)]]$ and
 $\exists x[\forall w \in W_{hope(x)} : \exists y[dragon_w(y)]]$

The crucial point is that the existential force of the indefinite article *a* can (and in fact preferentially does) take narrow scope with respect to the intensional quantification. (The descriptive content of *unicorn* and *dragon* can in fact be anchored to the actual world, but this is orthogonal to the question at hand.)

The attested interaction of indefinites with modals, negation, and adverbs also are fatal for Heim's proposal.⁹ Consider the LF for (98e):

- (104) a. ___ wasn't [_{VP} often [stationed [a kore_F]] in such a temple]
 b. ___ wasn't [_{VP} often [-stationed [-a kouros_F]] in such a temple]

Here, negation scopes over the adverb of quantification *often*, adjoined to VP and internal to the ellipsis site. *Often*, in turn, can outscope the contrasting indefinite derived subjects *a kore* and *a kouros*. On the most plausible readings of these sentences, which involve many different statues of young women and men, the indefinites must totally reconstruct to a position inside the VP, under *often*:

- (105) $\neg[\text{OFTEN}[\exists x[\text{kouros}(x) \wedge \exists y[\text{station}(\text{such_a_temple})(x)(y)]]]]]$

Note that the problems here are not resolvable by mere reformulation of the conditions, or by retreating from Heim's conclusion that the VPs denote formulas. The solution is that we need to allow focus alternatives to be computed for focus-marked material *internal* to the ellipsis site. Heim, by stipulation, rules out any F-marking inside the ellipsis site. This move is wrong. What is true is that there can be no pitch-accent inside an ellipsis site (since there is no phonological material to bear it), so constructions that conspire to require such a pitch accent (such as the fact that a focus-sensitive operator like *only* requires a pitch accent on its associate, as Tancredi 1992 discovered, and Erlewine 2014 discusses) will be ill-formed. But F-marking per se inside an ellipsis site at LF is fine, as long as the pitch accent associated with the F-marked material is outside the ellipsis site at PF. This is the kind of system that I proposed in 2001 (Merchant 2001), building on Schwarzschild's givenness system. In that work, I proposed that ellipsis was licensed just in case the elided XP and its antecedent were semantically equivalent to one another modulo F-marking.¹⁰

⁹See also Jacobson (1998) and Kennedy (2014) for discussion of additional examples that cannot be handled by Heim's proposal.

¹⁰As shown by Jeremy Hartman in a presentation in Brussels in 2009, there is a problem with Schwarzschild's type-raising everything to propositional type and comparing entailments. The problem comes from reversible predicates such as *defeat~lose to or be an older sibling of~be a younger sibling of*:

- (i) a. Abby defeated Ben \leftrightarrow Ben lost to Abby.
 b. Ben is an older sibling of Abby \leftrightarrow Abby is a younger sibling of Ben.
 Nevertheless, these predicates don't license ellipsis of their reversed counterparts:
 (ii) a. *Abby defeated Ben, so we know that Ben did ~~lose~~ to Abby.
 b. *Ben is an older sibling of Abby, so we can conclude that Abby is a ~~younger sibling~~ of Ben.

Hartman suggested retreating to an LF-identity condition, but we can simply use the type-flexible system of Rooth and get the desired result, replacing mutual entailment by semantic equivalence modulo focus (see (107) below); free variables can be bound by λ -operators for the purposes of the computation. So (ii.a) will be ruled out because $\lambda x \lambda y [\text{defeat}(y)(x)] \neq \lambda y \lambda x [\text{lose.to}(x)(y)]$.

This point was made most clearly with examples I dubbed ‘contrast sluicing’ in Merchant (2001):150, such as (106), where the quantificational force has to be calculated within the scope of the modal, and where the restrictors on the quantifiers contrast:

- (106) a. There may be nine women_F in the play, but I don’t know how many men_F.
 b. $\diamond \exists x[\text{women}(x) \wedge |x| \geq 9] \dots ?n \diamond \exists y[\text{men}(y) \wedge |y| \geq n]$

It is precisely by virtue of this focus that the ellipsis can go through: because both *women* and *men* are focussed, we look at their alternatives when calculating elliptical identity—the ordinary semantic value of the antecedent clause is an element of the focus-semantic value of the elliptical clause, and vice versa. The problem is that in these cases, the focused material must be inside the ellipsis site, which violates Heim’s third clause of (99) (and any theory of purely LF identity, such as Fiengo & May 1994).¹¹

The technical changes needed to account for the full range of data are trivial¹²: replace the existential closure of free variables of Schwarzschild (1999) with λ -closure, and replace the entailment condition with an inclusion condition:¹³

- (107) **e-GIVENness** (Roothian version)
 An expression E counts as e-GIVEN iff E has a salient antecedent (expressed or implied) A and, modulo λ -type-shifting,
 a. $\llbracket A \rrbracket \in \llbracket E \rrbracket^f$, and
 b. $\llbracket E \rrbracket \in \llbracket A \rrbracket^f$
- (108) Focus condition on ellipsis:
 An XP can be elided only if XP is e-GIVEN.

Once we have such a theory that allows us to abstract over focused elements, even when these reconstruct, or are interpreted inside the ellipsis site, we no longer need to say anything special about Greek verb movement (or Russian, etc.): the

¹¹But see especially Rudin (to appear) for a new take on sluicing licensing that differentiates it from VP-ellipsis in important ways.

¹²I have presented this theory many times over the past fifteen years in precisely these terms, calling it the Roothian version of my original Schwarzschildian formulation: as a matter of record, I discussed such a Roothian version in Merchant (2001) but pursued the one based on Schwarzschild’s theory of focus at that time.

¹³This version of e-GIVENness has the added advantage not just of handling Hartman’s examples with reversible predicates, but also of handling the example I worried about in (i) (from Merchant (2001):37 fn 17), where focus-closure and \exists -closure conspired to make VP_A and VP_E equivalent even when the focus-marking was anaphoric to some other sentence, not to the one containing the ellipsis:

- (i) A: Who did Abby see?
 B: *ABBY saw BEN, and CARLA did see someone, too.
 LF: $__ \text{PAST} [\text{VP}_A \text{ Abby}_F \text{ see Ben}_F]$, and $__ \text{PAST did} [\text{VP}_E \text{ Carla}_F \text{ see someone}]$

Since *Abby see Ben* $\notin \{\exists y[x \text{ see } y] : x \in D_e\}$, clause (a) of (107) isn’t satisfied, and ellipsis is correctly ruled out.

verb can move as usual (successive-cyclically, obeying the Head Movement Constraint or Relativized Minimality) and indeed can reconstruct totally, as long as the verb (or its stem) is focused. This is precisely what seems to be the state of affairs in Greek, as we've seen above.

The calculation of focus alternatives is as Rooth proposed: for a 2-place predicate, the set of alternatives are those in $D_{e,et}$. The parallelism condition on ellipsis is satisfied in case the ordinary value of the antecedent vP is an element of the focus value of the elided vP, and vice versa. For the Greek example in (90), repeated here, this will hold if both statements in (110) are true.

- (109) O Petros dhen VRIKE_F ena vivlio sti vivliothiki — EXASE_F.
the Petros not found._{3S} a book in.the library lost._{3S}
 'Petros didn't FIND a book in the library — he LOST one there.'
- (110) a. *Petros found a book in the library* ∈ {that Petros *P'*ed a book in the library:
 $P \in D_{e,et}$ }
- b. *Petros lost a book in the library* ∈ {that Petros *P'*ed a book in the library:
 $P \in D_{e,et}$ }

So Greek VSE is simply subject to the usual condition on VP-ellipsis (semantic equivalence modulo focus), and verbs in Greek are just like any other moving element: if focused, they can reconstruct (as predicates typically must, following Heycock (1995)), but the focus marking on their stems will allow that part of their meanings to vary (while other material is interpreted outside the vP in any case: Voice, Aspect, Tense). There is no particular Verbal Identity Requirement at all. Its effects fall out from focus-marking (or its lack, in certain cases).

5.1.2 IS FOCUS-MARKING ON VERBS RESTRICTED IN IRISH?

But where does this leave Irish? As McCloskey (2017) shows on the basis of a careful examination of a range of data, examples like the following (his (53)) are judged as unacceptable even when the contrastive interpretation is intended:

- (111) *Níor cheannaigh mé teach ariamh, ach dhíol.
NEG.PAST buy I house ever but sold
 'I never *bought* a house, but I *sold* one.'

It might be that Irish lacks the ability to abstract over focus alternatives on verbs for the purposes of ellipsis resolution. This would be an odd restriction, but if it can be maintained, then the usual semantic computation needed to generate the focus alternatives to resolve the ellipsis (whether using e-givenness or some other parallelism device) will not allow for the replacement of the verb stem's meaning with alternatives. This could be implemented by stipulating that Rooth's F-feature cannot attach to verbs in Irish, but it would be preferable to derive it from some independent property of how focus works in Irish, perhaps along the lines explored in Bennett et al. (2017). The primary initial difficulty with this idea is that, as Bennett et al. (2017) document, there are a range of constructions that make it appear that semantic focus is compatible with a verb root (their (26b)):

- (112) A: An ngéillfidh siad? B: Caithfidh SIAD.
 Q *yield.FUT they* *must they*
 ‘Will they yield (on this)?’ ‘They HAVE to.’

What is unusual about this and related examples displaying *verum focus* is that the pitch accent falls not on the verb itself, but on the following subject pronoun.

Bennett, Elfner, and McCloskey analyze this unusual pitch placement as essentially an ‘epiphenomenon of phrasing’ (p. 24), the result of the interaction of constraints favoring rightward accent placement and a special subject pronoun incorporation process. In any case, it is surely no accident that the most prominent language in which the Verbal Identity Requirement seems to hold is also the language that seems to have an allergy between focus prominence and verbal stems.¹⁴ When no pronoun is available, as is the case in synthetic verb forms (forms that inflect for person and number), the inflectional ending, not the stem, takes the accent:

- (113) An rabhadar ann? BhíODAR.
 Q *be.PAST.3pl in.it be.PAST.3pl*
 ‘Were they present? They certainly were.’

Most spectacularly, as Bennett et al. note in their footnote 16: “In the absence of a simple pronoun subject or an appropriate inflectional ending . . . , other means have to be found to express *Verum Focus*. . . the discourse particle *muis(e)*, whose meaning is, to say the least, unclear, may serve exactly this function in cases like ((114)):¹⁵

- (114) A: An raibh Colm ann? B: Bhí muis.
 Q *be.PAST Colm there be.PAST PARTICLE*
 ‘Was Colm there? He was indeed.’

The crucial empirical question is whether the addition of such a particle would ameliorate even cases of mismatched verb stems, such as (111) above. If so, then the problem with (111) may not be the lack of identity of the verb stems per se, but rather the lack of an appropriate position for the accent to fall, given the unusual requirements of Irish focal accent placement. The usual cases of VSE in Irish simply don’t involve such accents, and so can surface as mere verbs, with no following particle or subject, pronominal or otherwise. It is only in the cases where the Verbal Identity Requirement is tested that such accent is obligatory, and imposes these unusual additional requirements.

All of this, I hope, points to a possible solution that ties the appearance of the Verbal Identity Requirement to something special about how focus is handled in the grammar of Irish, as opposed to Greek and other languages.

¹⁴Lipták (2012) shows that Hungarian VSE, which can strand either a verb or a phrasal verbal marker, is also subject to a Verbal Identity Requirement except when the stranded verb and its antecedent are both contrastively focused (see especially Lipták (2013):84 fn 13); a full investigation of the interaction of focus and prosody and VSE in Hungarian will have to await a future occasion. Likewise for Brazilian Portuguese, as investigated in Santos (2009), Cyrino & Lopes (2013), and Lopes & Santos (2014).

5.2 CERTAIN ADJUNCTS

Landau (2017), building on Oku (1999), points out an important contrast between VSE in Hebrew and English VP ellipsis: English speakers very much prefer (in the absence of contrasting material) to interpret VP adjuncts as being part of an elided VP, while Hebrew speakers do not normally take such adverbs to modify a putative stranded verb. (115a), for example, is preferentially interpreted as ‘Beth didn’t clean her flute carefully’, not as merely ‘Beth didn’t clean her flute’. Likewise for the adverbs in the other cases as well.¹⁵

- (115) a. Abby cleaned her flute carefully, but Beth didn’t.
b. Abby has consistently worn her retainer, and Beth has, too.
c. Sebastian is deliberately wiping his fingers on the tablecloth because Ralph is.
d. Rufus wasn’t frequently seen at the library, but Arnold was.

Greek allows such adverbs to be interpreted inside the ellipsis site as well:

- (116) a. Parakratisan akrivos tris dhikigori epitidhes xrimata apo tus
withheld.3p exactly three lawyers intentionally money from the
pelates tus?
clients their
‘Did exactly three lawyers intentionally withhold money from their clients?’
b. Ne, parakratisan.
yes withheld.3p
‘Yes, exactly three did.’ (intentionally withhold money from their clients)
or ‘Yes, they did.’

When the adjunct can be taken as the sole scope of negation, the two readings can be readily distinguished. Landau (2017) provides the following Hebrew example (his (40a)), using the missing antecedent phenomenon (Grinder & Postal 1971) as the crucial test to diagnose ellipsis. The infelicity of the following anaphora (*hi*) shows not just that there was no ellipsis of a VP containing a DP antecedent for *hi* to be anaphoric to, but that such an elided VP cannot be posited at all. (So Hebrew has null definite objects, but not null adjuncts and no VSE at all.)

¹⁵One difficulty with the argument from adverbs is that even adverbs that cannot possibly be inside the antecedent VP seem to be able to be interpreted as though they were inside an elided VP, as in (i); perhaps such adverbs are fronted from some position inside the VP.

(i) Abby must consistently have worn her retainer; her sister certainly did ~~consistently wear her retainer~~.

- (117) Yosi afa et ha-uga lefi ha-matkon. hi hayta me'ula.
Yosi baked ACC the-cake according the-recipe it was fabulous
 'Yosi baked the cake according to the recipe. It was fabulous.'
- a. Gil lo afa __. #hi hayta mag'ila.
Gil not baked it was gross
 'Gil didn't bake the cake. It was gross.'
- b. Gil, lo. hi hayta mag'ila.
Gil not it was gross
 'Not Gil./Gil didn't. It was gross.'

A similar example in Greek (given with the non-elliptical control in (118) as well) shows the same pattern:

- (118) O Petros eftiakse turta akoluthondas tin sintaji. Itan nostimi.
the Petros made cake.fem following the recipe it.was delicious.fem
 'Petros made a cake according to the recipe. It was delicious.'
- a. O Markos dhen eftiakse. #Itan aidhiastiki.
the Markos not made it.was disgusting.fem
 'Markos didn't make one. It was disgusting.'
- b. O Markos oxi. Itan aidhiastiki.
the Markos no it.was disgusting.fem
 'Not Markos. It was disgusting.'
- c. O Markos dhen eftiakse turta akoluthondas tin sintaji.
the Markos not made cake.fem following the recipe
 J'afto, itan aidhiastiki.
for.that.reason it.was disgusting.fem
 'Markos didn't make a cake according to the recipe. It was disgusting.'

How can we reconcile these results with the evidence above that Greek does have VSE? We must seek another reason why the continuation in (118a) is judged deviant, while (118b,c) are not. That reason has already been hinted at above, however: some focus-sensitive operators, most famously English *only*, trigger an obligatory pitch accent on their associate. If this associate is elided while the operator is not, the result is judged infelicitous.¹⁶ Compare the following examples with and without VP ellipsis:

¹⁶See Beaver & Clark (2008):ch. 7 for some discussion. The requirement is one that applied when the dependency between the operator and the accent spans the boundary of an ellipsis site. If the operator itself is also elided, no deviance results:

(i) Abby said she only plays [the flúte]_F, and Ben did, too. (~~say she only plays~~ [the flúte]_F)
 This is presumably because the requirement is one of actual pitch accent, which secondary occurrence focus does not have: secondary occurrence focus shows prominence only through length and intensity, not pitch movement; see Baumann (2016).

- (119) Abby will only play [the flúte]_F at the recital, not the piano.
 a. Ben also will only play [the flúte]_F at the recital.
 b. *Ben also will only play ~~[the flúte]_F at the recital.~~

As discussed above, Heim mistakenly took such data to mean that F-marking could not be present inside an ellipsis site. As I have shown, that is incorrect. It is the requirement that pronounced *only* be associated with a pitch-accent on its associate that makes (119b) ill-formed, not the F-marking per se.

And precisely such a requirement holds of Greek *dhen* as well (but not of constituent negation *oxi*, used in the negative stripping example in (118b)). A more accurate representation of the focus marking of (118c) (similar to the facts studied in Johnson (1994)) would be as in (120), which makes clear why eliding a phrase that properly contains the adjunct would be impossible: the pitch accent required by *dhen* (falling on the final syllable of the adjunct, *ji*) could not be realized. There is no way to reduce or elide any phrase containing the adjunct *akoluthondas tin sintaji*.

- (120) O Markos dhen eftiakse turta [akoluthondas tin sintaji]_F.
the Markos not made cake.fem following the recipe
 ‘Markos didn’t make a cake [according to the recipe]_F. (He made it some other way, not according to the recipe.)’

We find the same results when we ensure that ellipsis is present by extracting from the ellipsis site. Since the PP *ja ton baba tu* ‘for his father’ is licensed by the elided embedded predicate *ftiaksi* ‘make’, not by the matrix predicate *borese* ‘was able’, we know that VSE has occurred. Nevertheless, the attempted anaphora is illicit.

- (121) Jan tin mama tu, o Markos borese na ftiaksi turta akoluthondas tin
for the mother his the Markos was.able SUBJ make cake following the
sintaji. (Itan nostimi.) Ja ton baba tu, dhen borese. (#Itan aidhiastiki.)
recipe it.was delicious for the father his not was.able it.was disgusting
 ‘For his mother, Markos was able to make a cake following the recipe. For his father, he wasn’t. (able to make a cake following the recipe)’

In this case, the pitch accent falls on the negator *dhen* in the last, contrasting sentence. This stress has the effect of placing the emphasis on the truth of the utterance; it is a kind of a *verum focus* (or *falsum focus*, in this case). There is a remaining, larger question why this negation, and the constituent negator *oxi* used in the negative stripping in (118b) above, cannot give rise to a reading that would make these sentences in effect equivalent to the narrow focus on the adjunct (since, of course, one way of ensuring falsity of the whole is to deny the applicability of the adjunct), but that is a question whose resolution raises questions beyond the scope of this paper. For our purposes, it is enough to note that such readings are unavailable with non-elliptical *falsum focus* sentences.

6 CONCLUSION

Greek has verb-stranding ellipsis, like Irish. Narrow focus on the verb stem can be used to vary the verb between the antecedent and the elided vP, in line with other elements that can move out of ellipsis sites (but still be wholly or in part interpreted inside them), because the ellipsis resolution condition is sensitive to focus alternatives, not to LF structure per se.

REFERENCES

- Alexiadou, Artemis. 1997. *Adverb placement: A case study in antisymmetric syntax*. Amsterdam: John Benjamins.
- Alexiadou, Artemis & Elena Anagnostopoulou. 1998. Parametrizing Agr: word order, V-movement and EPP-checking. *Natural Language and Linguistic Theory* 16(3). 491–539.
- Alexiadou, Artemis, Elena Anagnostopoulou & Florian Schäfer. 2015. *External arguments in transitivity alternations: A layering approach*. Oxford: Oxford University Press.
- Arvaniti, Amalia, D. Robert Ladd & Ineke Mennen. 2006. Tonal association and tonal alignment: Evidence from Greek polar questions and contrastive statements. *Language and Speech* 49(4). 421–450.
- Baumann, Stefan. 2016. Second occurrence focus. In Caroline Féry & Shinichiro Ishihara (eds.), *The Oxford handbook of information structure*, Oxford: Oxford University Press.
- Beaver, David & Brady Clark. 2008. *Sense and sensitivity: How focus determines meaning*. Chichester: Wiley-Blackwell.
- Bennett, Ryan, Emily Elfner & James McCloskey. 2017. Prosody, focus, and ellipsis in Irish. Ms., University of California, Santa Cruz.
- Bowers, John. 1993. The syntax of predication. *Linguistic Inquiry* 24(4). 591–656.
- Bowers, John. 2002. Transitivity. *Linguistic Inquiry* 33(2). 183–234.
- Bresnan, Joan. 2001. *Lexical-functional syntax*. London: Blackwell.
- Bruening, Benjamin. 2013. *By* phrases in passives and nominals. *Syntax* 16(1). 1–41.
- Chomsky, Noam. 1965. *Aspects of the theory of syntax*. Cambridge, Massachusetts: MIT Press.
- Chung, Sandra. 2000. Close encounters with pronouns in VP ellipsis. In Sandra Chung, James McCloskey & Nathan Sanders (eds.), *Jorge Hankamer WebFest*, <http://babel.ucsc.edu/Jorge/chung.html>.
- Chung, Sandra. 2006. Sluicing and the lexicon: The point of no return. In Rebecca T. Cover & Yuni Kim (eds.), *Proceedings of the annual meeting of the Berkeley Linguistics Society* 31, 73–91. Berkeley, Calif.: Berkeley Linguistics Society.
- Chung, Sandra. 2013. Syntactic identity in sluicing: How much, and why. *Linguistic Inquiry* 44(1). 1–39.
- Chung, Sandra, William A. Ladusaw & James McCloskey. 2010. Sluicing(:) Between structure and inference. In Line Mikkelsen, Eric Potsdam & Rodrigo

- Gutiérrez-Bravo (eds.), *Representing language: Essays in honor of Judith Aissen*, Santa Cruz, Calif.: Linguistics Research Center Publications.
- Culicover, Peter W. & Ray Jackendoff. 2005. *Simpler Syntax*. Oxford: Oxford University Press.
- Cyrino, Sonia & Ruth E. Vasconcellos Lopes. 2013. VP ellipsis, null objects, and aspect as a licensing category in Brazilian Portuguese. In *43rd linguistic symposium on romance languages*, 21–22.
- Dowty, David. 1981. Quantification and the lexicon: A reply to Fodor and Fodor. In M. Moortgat, M. Hulst & H.v.d. Hoekstra (eds.), *The scope of lexical rules*, Dordrecht: Foris.
- Erlewine, Michael Yoshitaka. 2014. *Movement out of focus*. Cambridge, Mass.: Massachusetts Institute of Technology dissertation.
- Fiengo, Robert & Robert May. 1994. *Indices and identity*. Cambridge, Massachusetts: MIT Press.
- Fillmore, Charles. 1986. Pragmatically controlled zero anaphora. In *Proceedings of Berkeley Linguistics Society 12*, 95–107. Berkeley, Calif.: Berkeley Linguistics Society.
- Fodor, Jerry A. & Janet Dean Fodor. 1980. Functional structure, quantifiers, and meaning postulates. *Linguistic Inquiry* 11(4). 759–770.
- Funakoshi, Kenshi. 2012. On headless XP-movement/ellipsis. *Linguistic Inquiry* 43. 519–562.
- Giannakidou, Anastasia. 2000. Negative...concord? *Natural Language and Linguistic Theory* 18(3). 457–523.
- Giannakidou, Anastasia & Jason Merchant. 1997. On the interpretation of null indefinite objects in Greek. *Studies in Greek Linguistics* 18. 141–154.
- Gillon, Brendan. 2012. Implicit complements: A dilemma for model theoretic semantics. *Linguistics and Philosophy* 35(4). 313–359.
- Goldberg, Lotus Madelyn. 2005. *Verb-stranding VP ellipsis: A cross-linguistic study*. Montreal: McGill University dissertation.
- Gribanova, Vera. 2013a. A new argument for verb-stranding verb phrase ellipsis. *Linguistic Inquiry* 44(1). 145–157.
- Gribanova, Vera. 2013b. Verb-stranding verb phrase ellipsis and the structure of the Russian verbal complex. *Natural Language and Linguistic Theory* 31. 91–136.
- Gribanova, Vera. 2017a. Head movement and ellipsis in the expression of Russian polarity focus. *Natural Language and Linguistic Theory* 00. 1–43.
- Gribanova, Vera. 2017b. Head movement, ellipsis, and identity. Ms., Stanford University.
- Gribanova, Vera. 2017c. Roots in ellipsis and multidominance. In Jason Ostrove, Ruth Kramer & Joseph Sabbagh (eds.), *Asking the right questions: Essays in honor of Sandra Chung*, 1–16. Santa Cruz, Calif.: Linguistics Research Center Publications.
- Gribanova, Vera & Line Mikkelsen. 2018. On the interaction of head movement and ellipsis in Danish. In Deniz Rudin, Kelsey Sasaki, Line Mikkelsen & Jason Merchant (eds.), *A reasonable way to proceed: A Festschrift in honor of James McCloskey*, Santa Cruz, Calif.: University of California, Santa Cruz.

- Grinder, John & Paul M. Postal. 1971. Missing antecedents. *Linguistic Inquiry* 2(3). 269–312.
- Hankamer, Jorge & Ivan A. Sag. 1976. Deep and surface anaphora. *Linguistic Inquiry* 7(3). 391–428.
- Harizanov, Boris & Vera Griбанова. 2017. Whither head movement? Ms., Stanford University.
- Heim, Irene. 1997. Predicates or formulas? evidence from ellipsis. In Aaron Lawson & Enn Cho (eds.), *Proceedings of salt vii*, Cornell University: CLC Publications.
- Heycock, Caroline. 1995. Asymmetries in reconstruction. *Linguistic Inquiry* 26(4). 547–570.
- Horrocks, Geoffrey & Melita Stavrou. 1987. Bounding theory and Greek syntax: Evidence for *wh*-movement in NP. *Journal of Linguistics* 23. 79–108.
- Jacobson, Pauline. 1998. ACE and pied-piping: Evidence for a variable-free semantics. In Devon Strolovitch & Aaron Lawson (eds.), *Proceedings of SALT 8*.
- Jacobson, Pauline. 2016. The short answer: Implications for direct compositionality (and vice versa). *Language* 92(2). 331–375.
- Johnson, Michael. 1994. *The semantics of adverbial adjuncts*. Santa Cruz, Calif.: University of California, Santa Cruz dissertation.
- Kennedy, Christopher. 1994. Argument contained ellipsis. Linguistics Research Center Report LRC-94-03 University of California, Santa Cruz.
- Kennedy, Christopher. 2014. Predicates *and* formulas: Evidence from ellipsis. In Luka Crnic & Uli Sauerland (eds.), *The art and craft of semantics: A festschrift for Irene Heim*, vol. 70, 253–277. Cambridge, Mass.: MITWPL.
- Landau, Idan. 2017. Missing objects in hebrew: Argument ellipsis, not vp ellipsis. Ms., Ben Gurion University.
- Lasnik, Howard. 2003. On a scope reconstruction paradox. *Minimalist Investigations in Linguistic Theory* 118–124.
- Levin, Beth & Malka Rappaport. 1988. What to do with θ -roles. In Wendy K. Wilkins (ed.), *Syntax and semantics 21: Thematic relations*, San Diego, California: Academic Press.
- Lipták, Anikó. 2012. Verb-stranding ellipsis and ~~verbal~~ identity: The role of polarity focus. *Linguistics in the Netherlands* 29(1). 82–96.
- Lipták, Anikó. 2013. The syntax of emphatic positive polarity in Hungarian: Evidence from ellipsis. *Lingua* 128. 72–92.
- Lipták, Anikó & Andrés L. Saab. 2014. No N-raising out of NPs in Spanish: ellipsis as a diagnostic of head movement. *Natural Language and Linguistic Theory* 32(4). 1247–1271.
- Lopes, Ruth E. Vasconcellos & Ana Lúcia Santos. 2014. VP-ellipsis comprehension in European and Brazilian Portuguese. In João Costa, Alexandra Fiéis, M. João Freitas, Maria Lobo & Ana Lúcia Santos (eds.), *New directions in the acquisition of romance languages*, 181–201. Newcastle upon Tyne: Cambridge Scholars Publishing.
- Manetta, Emily. 2018. We say “how high?”: Adverbs, negation and verb movement in a verb-final language. In Deniz Rudin, Kelsey Sasaki, Line Mikkelsen &

- Jason Merchant (eds.), *A reasonable way to proceed: A Festschrift in honor of James McCloskey*, Santa Cruz, Calif.: University of California, Santa Cruz.
- McCloskey, James. 1991. Clause structure, ellipsis and proper government in Irish. *Lingua* 85, 259–302.
- McCloskey, James. 1996. On the scope of verb movement in Irish. *Natural Language and Linguistic Theory* 14(1). 47–104.
- McCloskey, James. 2017. Ellipsis, polarity, and the cartography of verb-initial orders in Irish. Ms., University of California, Santa Cruz.
- Merchant, Jason. 2001. *The syntax of silence: Sluicing, islands, and the theory of ellipsis*. Oxford: Oxford University Press.
- Merchant, Jason. 2008. Variable island repair under ellipsis. In Kyle Johnson (ed.), *Topics in ellipsis*, 132–153. Cambridge: Cambridge University Press.
- Merchant, Jason. 2013a. Diagnosing ellipsis. In Lisa Lai-Shen Cheng & Norbert Corver (eds.), *Diagnosing syntax*, 537–542. Oxford: Oxford University Press.
- Merchant, Jason. 2013b. Polarity items under ellipsis. In Lisa Lai-Shen Cheng & Norbert Corver (eds.), *Diagnosing syntax*, 441–462. Oxford: Oxford University Press.
- Merchant, Jason. 2013c. Voice and ellipsis. *Linguistic Inquiry* 44(1). 77–108.
- Merchant, Jason. 2014. Gender mismatches under nominal ellipsis. *Lingua* 151. 9–32.
- Merchant, Jason. 2015. How much context is enough? Two cases of span-conditioned stem allomorphy. *Linguistic Inquiry* 46(2). 273–304.
- Merchant, Jason. 2016. Ellipsis: A survey of analytical approaches. To appear in Jeroen van Craenenbroeck and Tanja Temmerman (eds.), *The Oxford Handbook of Ellipsis*.
- Messick, Troy & Gary Thoms. 2016. Ellipsis, economy, and the (non)uniformity of traces. *Linguistic Inquiry* 47(2). 306–332.
- Mittwoch, Anita. 1982. On the difference between *eating* and *eating something*: activities versus accomplishments. *Linguistic Inquiry* 13(1). 113–122.
- Oku, Satoshi. 1999. LF copy analysis of Japanese null arguments. In M. Catherine Gruber, Derrick Higgins, Kenneth S. Olson & Tamra Wysocki (eds.), *Proceedings of CLS 34*, 299–314. Chicago, Illinois: Chicago Linguistics Society.
- Pollard, Carl Jesse & Ivan A. Sag. 1994. *Head-driven phrase structure grammar*. Stanford: Center for the Study of Language and Information ;.
- Rooth, Mats. 1992. Ellipsis redundancy and reduction redundancy. In Steve Berman & Arild Hestvik (eds.), *Proceedings of the stuttgart ellipsis workshop*, Stuttgart.
- Rudin, Deniz. to appear. Head-based syntactic identity in sluicing. *Linguistic Inquiry* .
- Saab, Andrés. 2016. Ineffable narratives in Spanish: Another case of overgeneration by e-GIVENness. *Probus* 28(2). 367–389.
- Saab, Andrés L. 2009. *Hacia una teoría de la identidad parcial en la elipsis*: University of Buenos Aires dissertation.
- Sadock, Jerrold M. 1991. *Autolexical syntax: A theory of parallel grammatical representations*. Chicago, Ill.: University of Chicago Press.

- Sag, Ivan A. 1976. *Deletion and logical form*. Cambridge, Massachusetts: Massachusetts Institute of Technology dissertation.
- Sag, Ivan A. & Jorge Hankamer. 1984. Toward a theory of anaphoric processing. *Linguistics and Philosophy* 7. 325–345.
- Sailor, Craig. To appear. The typology of head movement and ellipsis: A reply to Liptak and Saab. *Natural Language and Linguistic Theory Ms.*, University of Groningen.
- Santos, Ana Lúcia. 2009. *Minimal answers: Ellipsis, syntax, and discourse in the acquisition of European Portuguese*. Amsterdam: John Benjamins.
- Schuyler, Tamara. 2001. Wh-movement out of the site of VP ellipsis. In Séamas Mac Bhloscaidh (ed.), *Syntax at Santa Cruz*, 1–20. UC, Santa Cruz: Linguistics Department.
- Schwarzschild, Roger. 1999. Givenness, avoid F and other constraints on the placement of accent. *Natural Language Semantics* 7(2). 141–177.
- Spyropoulos, Vassilios, Anthi Revithiadou & Phoevos Panagiotidis. 2015. Verbalizers leave marks: evidence from Greek. *Morphology* 25(299–325).
- Tancredi, Christopher. 1992. *Deletion, deaccenting and presupposition*. Cambridge: Massachusetts Institute of Technology dissertation.
- Thomas, Jens, Chung-Pei Ma, Nicholas J. McConnell, Jenny E. Greene, John P. Blakeslee & Ryan Janish. 2016. A 17-billion-solar-mass black hole in a group galaxy with a diffuse core. *Nature* 532(7599). 340–342. <http://dx.doi.org/10.1038/nature17197>.
- Thoms, Gary. 2015. Syntactic identity, parallelism and accommodated antecedents. *Lingua* 166. 172–198.
- Warner, Anthony. 1985. *The structure of English auxiliaries: A phrase structure grammar*. Bloomington, Indiana: Indiana University Linguistics Club.

